



Hi5

2014 PRICE LIST

Table of Contents

Questions? 816-774-4050

August 1, 2014 Price List (Rev. A)

Finishes	4-9
Edge Details	10-12
Location Codes Pages	19-20
Power Choices	21-38
Options to add to tables	39-49



Accessories <i>(Credenzas, lecterns, AV carts, etc.)</i>	50-53
---	-------



Afix	54-55
------	-------



Canyon	56-60
--------	-------



Capitol	61-63
---------	-------



Coby <i>(Apron & Square Bases)</i>	64-77
---	-------



Empire <i>(Adjustable height)</i>	78-85
--------------------------------------	-------



Gateway	86-94
---------	-------

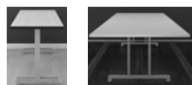

Harbor <i>(Hidden Wheel Option)</i>	95-103
--	--------

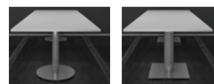

Island <i>(Round and Square Bases)</i>	104-107
---	---------



Pinnacle <i>(Occasional tables)</i>	108-110
--	---------



Railway <i>(Panel, Cube, Rectangle & U Shaped Bases)</i>	111-122
---	---------

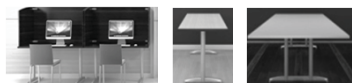

Supreme 123-135	
--------------------	--



Union Contemporary	136-142
--------------------	---------

ORDERING FINISH SAMPLES

Please contact your local Hi5 sales representative or contact the factory at 816-774-4050. For laminate samples, please visit laminate manufacturer's website. All finish samples will ship standard ground unless otherwise noted. If an expedited delivery is requested, customers will need to provide a UPS or FedEx account number for billing.

HPL LAMINATE FINISHES

All standard finishes are included in Hi5 list prices. When the back of the laminate sample is marked "PREMIUM", Contact Factory for 10% - 20% up charge. For the most up to date list of Standard and Premium finishes, please visit the laminate manufacturer's website listed below. For Ultra Premium Laminates or LAMIN-ART®, ABET®, ARPA , please Contact Factory for up charges.

Approved Cleaning Agents: Lestoil®, PineSol®, Top Job®, Fantastik®, Joy®, Formula 409® All-Purpose Cleaner, Crystal Simple Green® Cleaner, Dow Bathroom Cleaner®, Ammoniated and/or Vinegar-based Glass Cleaner. We do not recommend the use of any cleaners with bleach, anti-bacteria formulas, abrasive cleaners/powders or abrasive coated scouring pads. Varnish, lacquer and oil base paints can be removed from laminate by thorough cleaning using proper solvent or paint remover.



WILSONART® www.wilsonart.com

Standards: -60 (Matte), -38 (Fine Velvet)

Premiums Include: -07 (Textured Gloss), -12 (SoftGrain), -22 (Antique), -01 (High Gloss), -18, (Linearity), -52 (Quarry), -78 (Fine Grain), -90 (Crystal); Ultra Premiums Include: -35 (Mirage), -45 (Facet), -55 (Glaze)



FORMICA® www.formica.com

Standards: -58 (Matte)

Premiums Include: -09 (Brushed), -15 (Quilted), -42 (Sparkle), -43 (Artisan), -45 (Punched), -46 (Etchings), -47 (Powdered), -77 (Honed), -90 (Polished), -CT (Chetop2), -FV-Velour), -LX (Luxe), -MC (MicroDOT), -NT (Naturelle), -RD (Radiance), - RW (River wash), -SP(Sculpted), Grained, Midgrain, AR Plus, Chiselled, Gloss, NDF, Quarry, Rigato, Softmat



PIONITE® www.pionite.com

Standards: Suede

Premiums Include: G (Gloss), J (Crystal), H (Hi-Brite), Z (Ashwood), C (Soft Leather), L (Embossed Leather), W (Embossed Slate), Granite, Hi-Brite, Leather, Line Z, Linen, Medium Gloss, Soft Leather, StoneX, Super Matte, Wood Essence



ARBORITE www.arborite.com (ADD 1 WEEK LEAD TIME TO ALL ARBORITE)

Standards: CA (Cashmere), DI (Diamond), LQ (Lagwood), VL (Velvatex)

Premiums Include: GL (Gloss), BC (Breccia), EV (Evergrain), FP (French Polish), LM (Luminous), RM (Refined Matte), MX (Metalux), SR (Structured)



NEVAMAR® www.nevamar.com (ADD 3 WEEKS LEAD TIME TO ALL NEVAMAR)

Standard Pricing: T (Textured)

Premiums Include: G (Gloss), CR (Crystal), Z (Ashwood), B (Leather), CA (ChemArmor), N (Hi-Luster), PV (Polished Velvet), V (Velvet), Counter V, Leather, Super Matte, Textured With ARP, Wood Essence

NOTE: ChemSurf laminate is \$55 list per square foot.



Designer White Available on:
aFlx, Coby, Empire, Gateway,
Harbor, Island, Supreme

Designer White (WT)



Medium Tone Available on:
aFlx, Coby, Empire, Gateway,
Harbor, Island, Supreme

Medium Tone (MT)



Inner Tone Light Available on:
aFlx, Coby, Empire, Gateway,
Harbor, Island, Supreme

Inner Tone Light (IT)



Brown Available on:
aFlx, Coby, Empire, Gateway,
Harbor, Island, Supreme

Brown (BN)

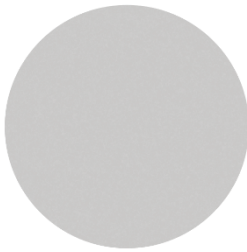

Silver Available on:
aFlx, Coby, Empire, Gateway,
Harbor, Island, Railway, Supreme

Modesty Panels
Power Boxes

Silver (SL)



Graphite Metallic Available on:
aFlx, Coby, Empire, Gateway,
Harbor, Island, Supreme

Graphite Metallic (GM)



Charcoal Available on:
aFlx, Coby, Empire, Gateway,
Harbor, Island, Supreme

Charcoal (CH)



Black Wrinkle Available on:
aFlx, Coby, Empire, Gateway,
Harbor, Island, Supreme

Black Wrinkle (BW)



Shadow Metallic Available on:
aFlx, Coby, Empire, Gateway,
Harbor, Island, Supreme

Shadow Metallic (SH)



Black Matte Available on:
aFlx, Coby, Empire, Gateway,
Harbor, Island, Supreme

Modesty Panels
Power Boxes

Black Matte (BM)



Polished Aluminum Available on:
Harbor, Supreme

*See upcharge per collection

Polished Aluminum (CR)



Polished Chrome Available on:
aFlx (round only), Gateway,
Island (round only)

*See upcharge per collection

Polished Chrome (CR)

Printed finishes may vary from actual finish color, contact Hi5 for actual sample.
Orders with 30 or more tables, custom color edges are available – Contact Factory for color choices and pricing.

5 VINYL EDGE FINISHES – L3 & L5 edge styles

August 1, 2014 Price List (Rev. A)

Custom PVC Upcharge: Contact Factory for pricing. Model Code: UCE

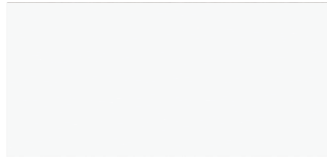

Designer White (DW)
Matches WA D354-60
Designer White
Available Edges: L3, L11



Ivory (IV)
Matches WA 1503-60 Putty
Available Edges: L3, L11

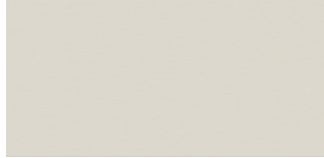

Inner Tone Light (IT)
Matches WA D327-60
Pepperdust
Available Edges: L3, L11

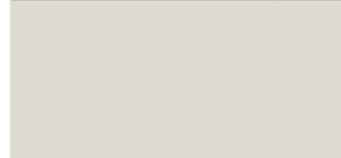

Silver (SL)
Matches WA D92-60
Dove Grey
Available Edges: L3, L11



Shadow (SH)
Matches WA D96-60
Shadow
Available Edges: L3, L11



Charcoal (CH)
Matches WA D90-60
North Sea
Available Edges: L3, L11



Medium Tone (MT)
Matches WA D91-60
Slate Grey
Available Edges: L3, L11

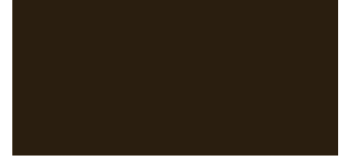

Brown (BN)
Matches Pionite ST604
Nubian Brown
Available Edges: L3, L11



Black (BK)
Matches WA 1595-60 Black
Available Edges: L3, L11

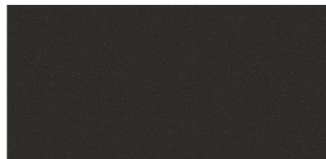

Graphite Nebula (GN)
Matches WA 4623-60
Graphite Nebula
Available Edges: L3, L11



Manitoba Maple (MA)
Matches WA 7911-60
Available Edges: L3, L11



Monticello Maple (MO)
Matches WA 7925-38
Available Edges: L3, L11



Huntington Maple (HU)
Matches WA 7929-38
Available Edges: L3, L11



Castle Oak (CO)
Matches WA 7928-38
Available Edges: L3, L11



Solar Oak (SO)
Matches WA 7816-60
Available Edges: L3, L11



Biltmore Cherry (BC)
Matches WA 7924-07
Available Edges: L3, L11



Shaker Cherry (SC)
Matches WA 7935-07
Available Edges: L3, L11



Colombian Walnut (CW)
Matches WA 7943-07
Available Edges: L3, L11



Brighton Walnut (BW)
Matches WA 7922-07
Available Edges: L3, L11



Empire Mahogany (EM)
Matches WA 7122-07
Available Edges: L3, L11

Printed finishes may vary from actual finish color, contact Hi5 for actual sample.
Orders with 30 or more tables, custom color edges are available – Contact Factory for color choices and pricing.

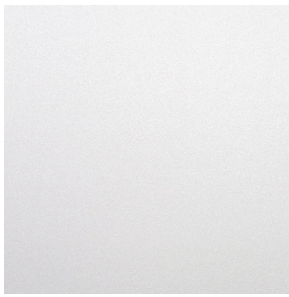

Frost White
Close to Laminate:
WA 1573-60 Frosty White
Available on Edges: F1 – F4



Warm White
Similar to Laminate:
WA D403-60 White Sand
Available on Edges: F1 – F4



Venus Silver
No Matches to HPL Laminate
Available on Edges: F1 – F4



Shimmer
No Matches to HPL Laminate
Available on Edges: F1 – F4

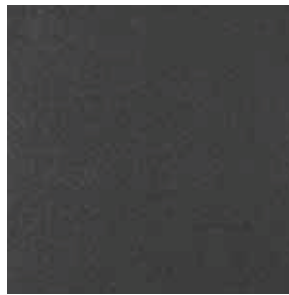

Shark Gray
Similar to Laminate:
Formica 912-58 Storm
Available on Edges: F1 – F4



Cashmere Fiber
Similar to Laminate:
WA 4608-60 Caldera Beige
Available on Edges: F1 – F4



GlaStone Ash
Similar to Laminate:
WA 1813K-35 Deepstar Glaze
Available on Edges: F1 – F4



Mineral Amber
Similar to Laminate:
WA 1842-45 Canyon Passage
Available on Edges: F1 – F4



Mineral Geode
No Matches to HPL Laminate
Available on Edges: F1 – F4



Laguna Pebble
No Matches to HPL Laminate
Available on Edges: F1 – F4



American Natural
Close to Laminate:
WA 7909-60 Fusion Maple
Available on Edges: F1 – F4



Almond Cherry
Similar to Laminate:
Formica 7737-58 Natural Cherry
Available on Edges: F1 – F4

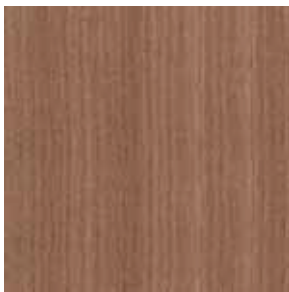

River Cherry
Close to Laminate:
WA 7937-38 River Cherry
Available on Edges: F1 – F4



Hayward Cherry
Close to Laminate:
WA 7919K-78 Amber Cherry
Available on Edges: F1 – F4



Urban Walnut
Similar to Laminate:
WA 7110K-78 Montana Walnut
Available on Edges: F1 – F4

Printed finishes may vary from actual finish color, contact Hi5 for actual sample.

#5 WOOD EDGES AND VENEER FINISHES

August 1, 2014 Price List (Rev. A)

Custom Finish: \$600 List per color match. Model Code: UCS



Manitoba Maple (MA)
Matches WA 7911-60
Stained on Plain Sliced
Hard Maple



Monticello Maple (MM)
Matches WA 7925-38
Stained on Plain Sliced
Hard Maple



Huntington Maple (HU)
Matches WA 7929-38
Stained on Plain Sliced
Hard Maple



Castle Oak (CO)
Matches WA 7928-38
Stained on Plain Sliced
Red Oak



Solar Oak (SO)
Matches WA 7816-60
Stained on Plain Sliced
Red Oak



Mocha Oak (MO)
No Laminate to Match
Stained on Plain Sliced
Red Oak



Biltmore Cherry (BC)
Matches WA 7924K-07
Stained on Plain Sliced
Cherry



Shaker Cherry (SC)
Matches WA 7935K-07
Stained on Plain Sliced
Cherry



Dark Cherry (DC)
No Laminate to Match
Stained on Plain Sliced
Cherry



Columbian Walnut (CW)
Matches WA 7943-07
Stained on Plain Sliced
Cherry



Brighton Walnut (BW)
Matches WA 7922K-07
Stained on Plain Sliced
Cherry



Mocha Walnut (MW)
No Laminate to Match
Stained on Plain Sliced
Cherry



Empire Mahogany (EM)
Matches WA 7122T-07
Stained on Plain Sliced
Cherry



Onyx (OX)
No Laminate to Match
Stained on Plain Sliced
Cherry

All veneer is grade A, plain sliced grain.
Custom stain is available – specify model code: CS, list price is \$600 per color.
Please provide sample to match, factory will match and send sample for approval.
Printed finishes may vary from actual finish color, contact Hi5 for actual sample.

SOLID SURFACE FINISHES – S1 edge styles



Printed finishes may vary from actual finish color, contact Hi5 for actual sample.

August 1, 2014 Price List (Rev. A)



Icy White

Similar to Corian color
Glacier White



Klondike

Similar to Corian color
Burnt Amber



Sand Castle

Similar to Corian color
Sandstone



Flax

Similar to Corian color Linen



Starry Night

Similar to Corian color
Black Quartz



Dune

Similar to Corian color Mojave



Oyster

Similar to Hi-Macs color
Almond Pearl



Clay

Similar to Corian color Silt



Dakota



Desert

Similar to Corian color Sahara



Pebble Beach

Similar to Corian color
Savannah



Sedona

Similar to Corian color
Matterhorn



Mesa

Similar to Hi-Macs color
Aztec Quartz



Arroyo

Similar to Corian color Canyon



North Ridge

Similar to Corian color
Kilimanjaro



Santa Fe

Similar to Corian color Maiu



Blue Lagoon

Similar to Corian color
Mediterranean



Tundra

Similar to Corian color
Platinum



Heartland

Similar to Corian color Prairie



Earth

Similar to Corian color Terra



Chocolate Chip

Similar to Corian color
Cocoa Brown



Chestnut

Similar to Corian color Granola



Ambrosia



Opus

Similar to Corian color Fossil



Montana

Similar to Staron color
Quarry Bluff



Meridian

Similar to Hi-Macs color
Volcanic Latitude



Kona

Similar to Hi-Macs color
Volcanic Kohala



Jakarta

Similar to Hi-Macs color
Volcanic Cameroon



Volcanic Ash

Similar to Hi-Macs color
Volcanic Tambora



Coral Quartz

#5 EDGE PROFILES

August 1, 2014 Price List (Rev. A)



1.25" thick laminate / wood veneer top.
EDGE: Comfort 2" w x 1.25" h
Solid wood edges.
Mitered square corners.



1.25" thick laminate / wood veneer top.
EDGE: Square 1.25" w x 1.25" h
Solid wood edges.
Mitered square corners.



1.25" thick laminate / wood veneer top.
EDGE: Knife 2" w x 1.25" h
Solid wood edges.
Mitered square corners.



1.25" thick laminate / wood veneer top.
EDGE: Square 1.25" w x 1.25" h
Solid wood edges.
Mitered square corners.



1.25" thick laminate / wood veneer top.
EDGE: Bevel 2" w x 1.25" h
Solid wood edges.
Mitered square corners.



1.25" thick laminate / wood veneer top.
EDGE: Square 2" w x 1.25" h
Solid wood edges.
Mitered square corners.



1.25" thick laminate / wood veneer top.
EDGE: Traditional 2" w x 1.25" h
Solid wood edges.
Mitered square corners.



1.25" thick laminate / wood veneer top.
EDGE: Square 2" w x 1.75" h
Solid wood edges.
Mitered square corners.



1.25" thick laminate / wood veneer top.
EDGE: Reeded 1.25" w x 1.25" h
Solid wood edges.
Mitered square corners.



1.25" thick laminate / wood veneer top.
EDGE: Square 2.75" w x 1.75" h
Solid wood edges.
Mitered square corners.



L17



W17



L18



W18



1.25" thick laminate / wood veneer top.
EDGE: Bull nose .625" w x 1.25" h
Baltic birch (apple ply) wood edges.
Mitered square corners.

1.25" thick laminate / wood veneer top.
EDGE: Knife 2" w x 1.25" h
Baltic birch (apple ply) wood edges.
Mitered square corners.



L21



W21



L22



W22



1.25" thick laminate / wood veneer top.
EDGE: Waterfall 1.25" w x 1.25" h
Solid wood edges.
Mitered square corners.

1.25" thick laminate / wood veneer top.
EDGE: Bull nosed 1.25" w x 1.25" h
Solid wood edges.
Mitered square corners.



L31



W31



L32



W32



1.25" thick laminate / wood veneer top.
EDGE: Waterfall 2" w x 1.25" h
Solid wood edges.
Mitered square corners.

1.25" thick laminate / wood veneer top.
EDGE: Bull nosed 2" w x 1.25" h
Solid wood edges.
Mitered square corners.



L41



W41



L42



W42



1.25" thick laminate / wood veneer top.
EDGE: Waterfall 2" w x 1.75" h
Solid wood edges.
Mitered square corners.

1.25" thick laminate / wood veneer top.
EDGE: Bull nosed 2" w x 1.75" h
Solid wood edges.
Mitered square corners.



L51



W51



L52



W52



1.25" thick laminate / wood veneer top.
EDGE: Waterfall 2.75" w x 1.75" h
Solid wood edges.
Mitered square corners.

1.25" thick laminate / wood veneer top.
EDGE: Bull nosed 2.75" w x 1.75" h
Solid wood edges.
Mitered square corners.

#5 EDGE PROFILES

August 1, 2014 Price List (Rev. A)



L3



1.25" thick laminate top.
EDGE: Flat 3mm High
Impact PVC
Square corners.



L10



1.25" thick laminate top.
EDGE: Knife laminated /
sealed
Square corners.



L5



1.25" thick laminate top.
EDGE: 5/8" Bull nose vinyl
3" Radius corners.
Only available in Black.

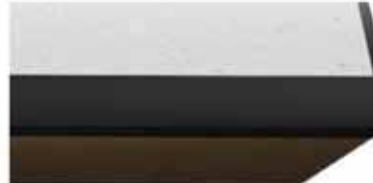

L11



1.25" thick laminate top.
EDGE: Knife 3mm PVC /
sealed
Square corners.



L6



1.25" thick laminate top.
EDGE: Self edges
Square corners.



F1



1.25" thick Forma Wrap top.
EDGE: 1/8" Eased
Square corners.



L9



1.25" thick laminate top.
EDGE: Drop Self Edge
1.25" w x 2" h
Square corners.



F2



1.25" thick Forma Wrap top.
EDGE: Comfort edge
Square corners.

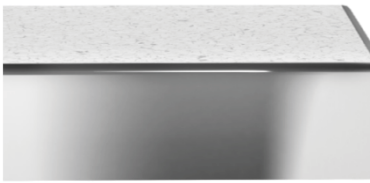

L7



1.25" thick laminate top.
EDGE: 1.5 mm Aluminum
inlay PVC
Square corners.



F3



1.5" thick Forma Wrap top.
EDGE: Stand-Off Knife
Square corners.



S1



1.5" thick solid surface top.
EDGE: 1/8" Eased .75" w
x 1.5" h
Square corners.



F4



1.25" thick Forma Wrap top.
EDGE: No Drip
Square corners.

*Note: Seating Capacity based on 30" per seat.

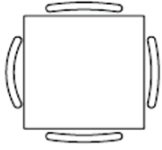

SQUARES

Table Size	Seating Capacity
24"	2
30"	2
36"	4
42"	4
48"	4/8
54"	4/8
60"	8
72"	8/12
84"	8/12
96"	12
108"	12-16
120"	16

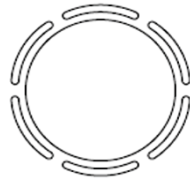

ROUNDS

Table Size	Seating Capacity
24"	2
30"	2
36"	3-4
42"	4
48"	4-5
54"	5-6
60"	6-7
72"	7-8
84"	8-10
96"	10-11
108"	11-13
120"	12-14

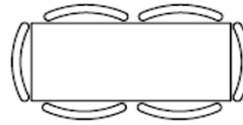

RECTANGLES

Table Size	Training Capacity	Meeting Capacity
18 x 30	1	NA
18 x 60	2	NA
18 X 66	2	NA
18 x 72	2	NA
18 x 84	3	NA
18 x 90	3	NA
18 x 96	3-4	NA
18 x 108	4	NA
18 x 120	4-5	NA
24 x 30	1	2
24 x 36	1	2
24 x 48	1	4
24 x 54	2	4
24 x 60	2	6
24 x 66	2	6
24 x 72	2	6
24 x 78	3	6
24 x 84	3	6
24 x 90	3	8
24 x 96	3-4	8
24 x 108	4	8
24 x 120	4-5	10
24 X 132	4-5	10-12
24 x 144	5	12
30 x 36	1	2
30 x 48	1	4
30 x 54	2	4
30 x 60	2	6
30 x 66	2	6
30 x 72	2	6
30 x 78	3	6
30 x 84	3	6
30 x 90	3	8
30 x 96	3-4	8
30 x 108	4	8
30 x 120	4-5	10
30 X 132	4-5	10-12
30 x 144	5	12
36 x 48	1	4
36 x 54	2	4
36 x 60	2	6
36 x 66	2	6
36 x 72	2	6
36 x 78	3	6
36 x 84	3	6
36 x 90	3	8
36 x 96	3-4	8
36 x 108	4	8
36 x 120	4-5	10
36 X 132	4-5	10-12
36 x 144	5	12

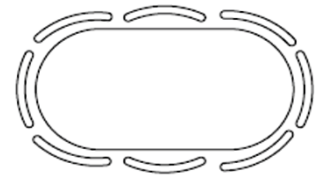

CONFERENCE

Table Size	Seating Capacity
42 X 60	6
42 X 72	6
42 X 84	6
42 X 90	8
42 X 96	8
42 X 108	8-10
42 X 120	10
42 X 132	10-12
42 X 144	12
42 X 168	14
42 X 192	14
42 X 216	16
42 X 240	16
42 X 264	18
42 X 288	18
48 X 60	6
48 X 72	6
48 X 84	6
48 X 90	8
48 X 96	8
48 X 108	8-10
48 X 120	10
48 X 132	10-12
48 X 144	12
48 X 168	14
48 X 192	14
48 X 216	18
48 X 240	18
48 X 264	20
48 X 288	20
60 X 72	8
60 X 84	8
60 X 90	10
60 X 96	10
60 X 108	10-12
60 X 120	12
60 X 132	12
60 X 144	12-14
60 X 168	14
60 X 192	14-16
60 X 216	18
60 X 240	20
60 X 264	20-22
60 X 288	22-24
72 X 84	8
72 X 90	10
72 X 96	10
72 X 108	10-12
72 X 120	12
72 X 132	12
72 X 144	12-14
72 X 168	14
72 X 192	14-16
72 X 216	18
72 X 240	20
72 X 264	20-22
72 X 288	22-24

#5 TOP SHAPES

August 1, 2014 Price List (Rev. A)

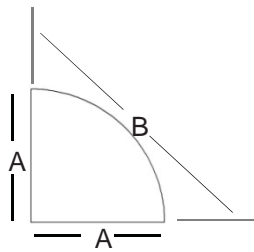

Quarter Round

A	B
24"	33.93"
30"	42.43"
36"	50.87"

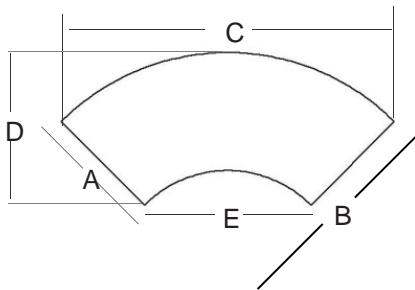

Crescent

A	B	C	D	E
24"	48"	67.87"	31"	33.93"
30"	60"	84.81"	38.75"	42.43"

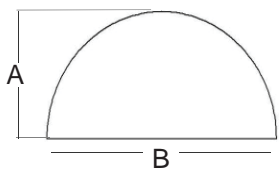

Half Round

A	B
24"	48"
30"	60"
36"	72"

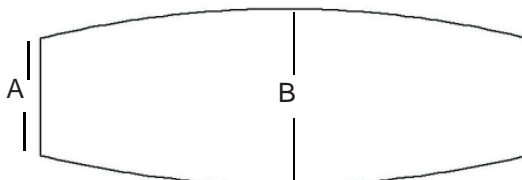

Boat

A	B
36"	48"
48"	60"

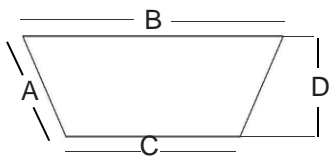

Trapezoid

A	B	C	D
24"	60"	36"	20.75"
24"	72"	48"	20.75"
30"	60"	30"	26"
30"	72"	42"	26"

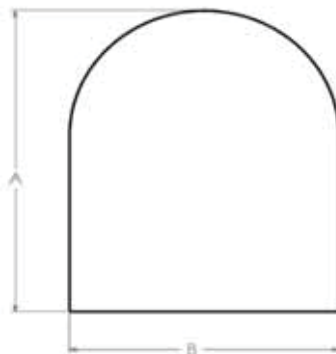

D-Top

A	B
24"	33.93"
30"	42.43"
36"	50.87"

BASE PLACEMENT FOR TRAINING TABLES

August 1, 2014 Price List (Rev. A)

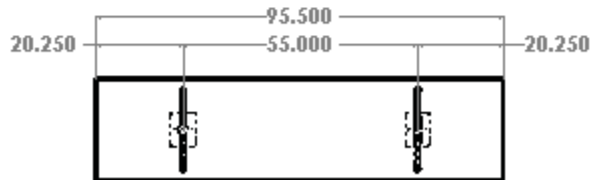
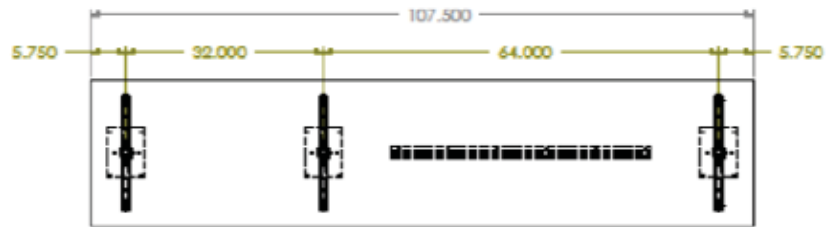
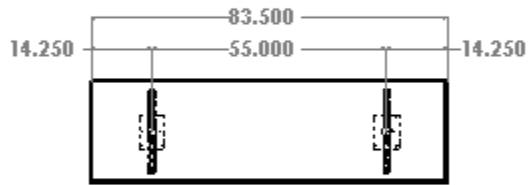
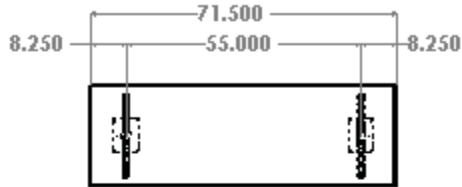
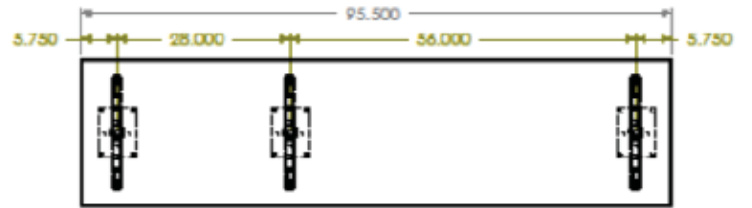
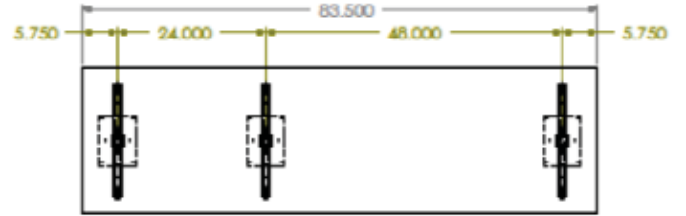
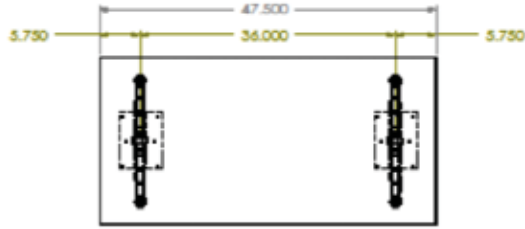
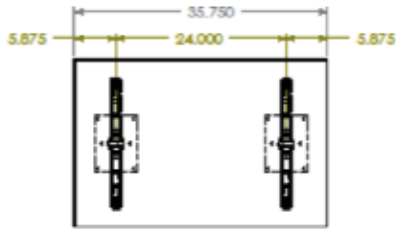

BASE PLACEMENT FOR TRAINING TABLES

August 1, 2014 Price List (Rev. A)

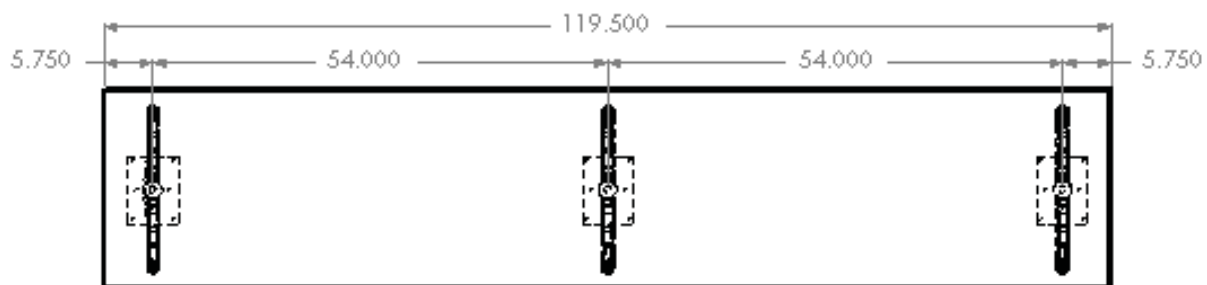
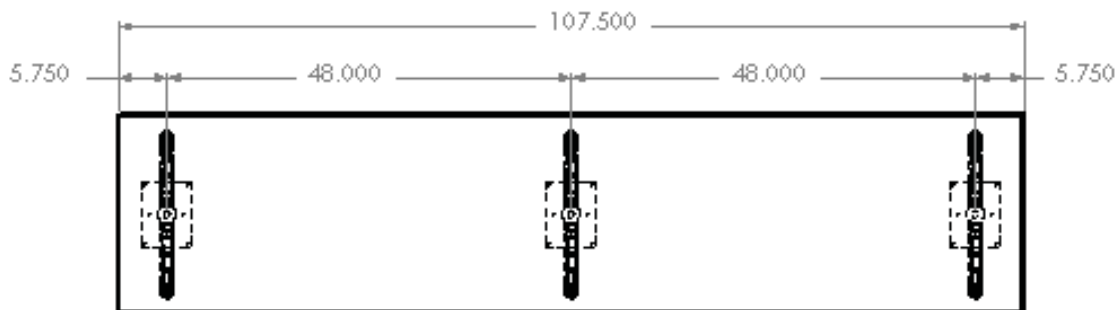
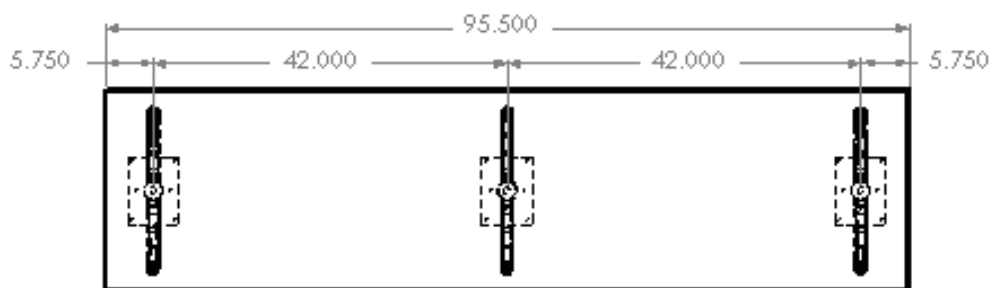
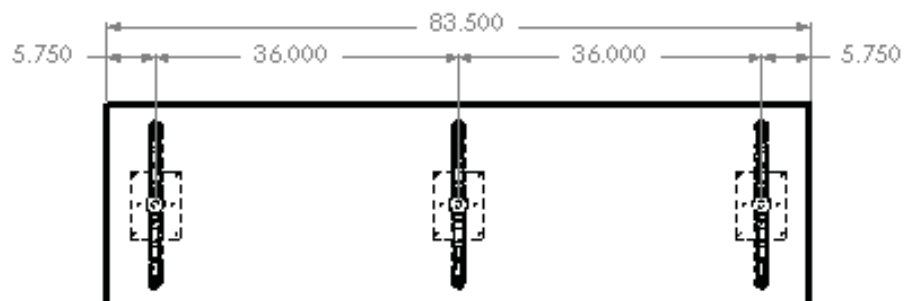

In order from lowest price to highest price

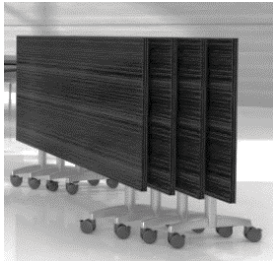

Supreme Tables

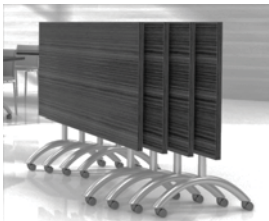
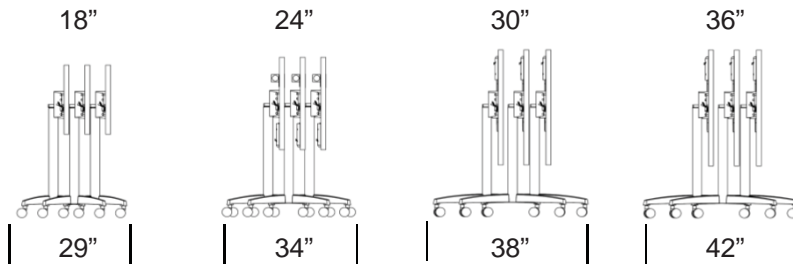

Gateway Tables

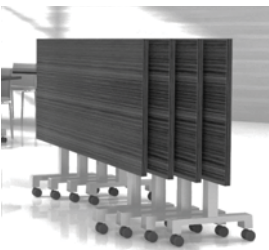
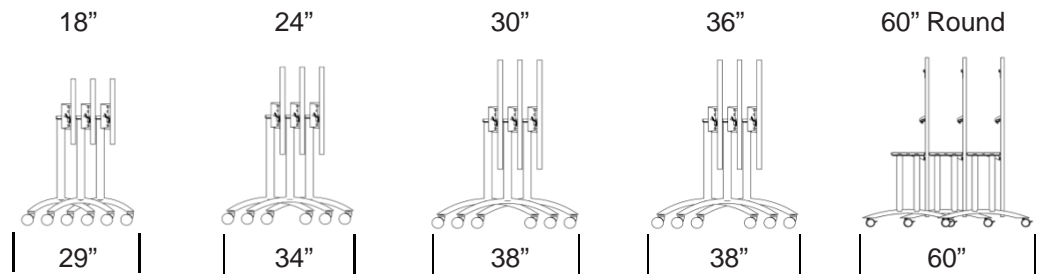

Harbor Tables

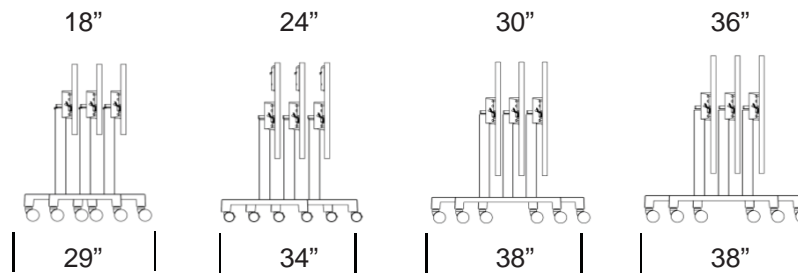

Empire Tables

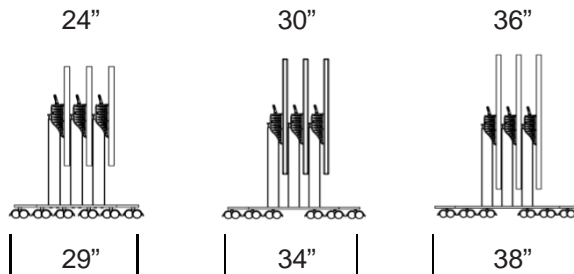

5 HOW TO BUILD MODEL CODE & SPEC POWER

August 1, 2014 Price List (Rev. A)

Base Product Code :

<u>LY</u>	<u>T1</u>	<u>2460</u>	<u>RE</u>	<u>S</u>	<u>L3</u>
Product Line	Base style	Top size	Top shape	Table function	Top edge

Options in Alphabetical Order

PRODUCT LINE CODES		BASE STYLE CODES		TOP SHAPE CODES		TABLE FUNCTION CODE	
AX	aFIX	AP	Apron Base	BT	Boat	A	Spring Pin Adjustable
CN	Canyon	C1	C base with 1 column	CR	Crescent	E2	Electric 2 stage
CL	Capitol	CL	Conference/Cube HPL	CS	Custom Shaped	E3	Electric 3 stage
CY	Coby	CV	Conference/Cube Veneer	DS	D Shape	F	Folding
EE	Empire	D1	Round disc with 1 column	EL	Elliptical / Oval	H	Hand Crank
GY	Gateway	D8	8" aFIX base	HR	Half Round	P	Pneumatic
HR	Harbor	P2	Post Leg 2"	HX	Hexagon	R	Ratchet
ID	Island	P3	Post Leg 3"	PE	Pie	N	Nesting
OC/S/R	Pinnacle	P4	Post Leg 4"	QR	Quarter Round	S	Stationary
RY	Railway	P6	Post Leg 6"	RD	Round		
SP	Supreme	PC	aFIX base with cover	RE	Rectangle		
UN	Union Contemp.	PL	Panel HPL base	RT	Racetrack		
		PV	Panel Veneer base	SQ	Square		
DISCONTINUED		Q1	Square disc with 1 column	TW	Tele-wedge		
COLLECTIONS:		RL	Rectangle HPL base	TZ	Trapezoid		
BN	Brooklyn	RV	Rectangle Veneer base	VH	Video Conference		
LH	Launch	SQ	Square Base				
LY	Liberty	T1	T base with 1 column				
MN	Madison	T2	TT base with 2 columns				
MC	Magic	TL	Training HPL base				
PR	Pier	TV	Training Veneer base				
SH	Stealth	UL	U shaped base in HPL				
SY	Speedway	UV	U shaped base in Veneer				
TR	Tower	X1	X base with 1 column				
UN	Union Trad.	X4	X base with 4 columns				
		Y0	Y base without stretcher				
		Y1	Y base with stretcher				

See pages 21 – 38 for all power choices

- Each power box comes standard with a set amount of electrical outlets. Select the power box or quantity of power boxes that equal the total number of outlets you want in your table.
Note the recommendations at the top of each page: i.e. mobile nesting tables, conference tables, CPU tables, etc.
- Determine if your power boxes need to link together or will they each plug into the floor individually. Double check to be sure the power boxes you selected in step #1 are available in linking if this is what you need.
- Follow the steps on the pricing page of the power box you selected.
If you selected the Power Pak, Concept, Regular, Large, Double, Mini-Oasis, Oasis, Marina, or Poly Trough, see page 22 for AV plate options. All actual jacks are included in the pricing.



Table Ganger Location A



Table Ganger Location B

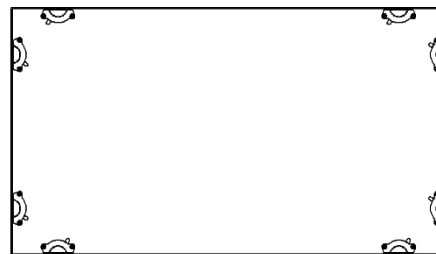

Table Ganger Location C

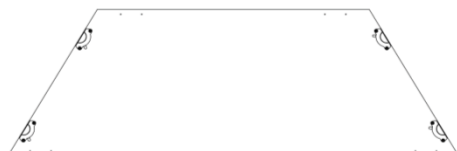

Table Ganger Location A



Table Ganger Location B

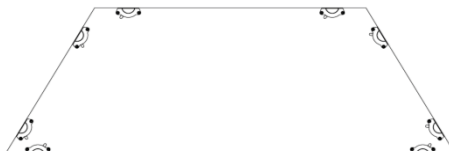

Table Ganger Location C

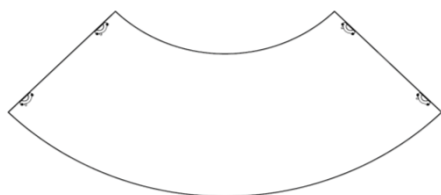

Table Ganger Location A

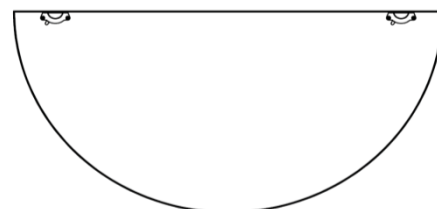
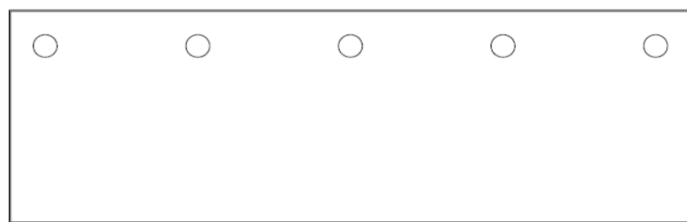
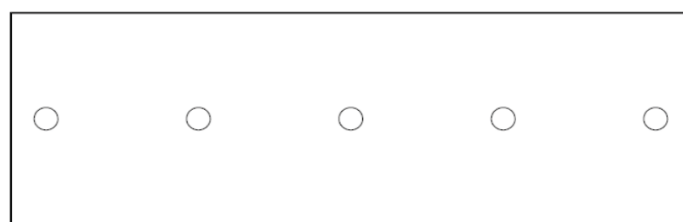

Table Ganger Location D



Grommet Location G1 Grommet Location G2 Grommet Location G3 Grommet Location G4 Grommet Location G5



Grommet Location G6 Grommet Location G7 Grommet Location G8 Grommet Location G9 Grommet Location G10



Grommet Location P1 Grommet Location P2 Grommet Location P3 Grommet Location P4 Grommet Location P5



Grommet Location P6 Grommet Location P7 Grommet Location P8 Grommet Location P9 Grommet Location P10

5 POWER LOCATION CODES

August 1, 2014 Price List (Rev. A)

VILLA POWER BOX:

Training Tables



Pa



Pb and Pc

REGULAR POWER BOX:

Training Tables



Pa



Pb and Pc

Conference Tables



Pd



Pe and Pf



Pg and Ph

LARGE POWER BOX:

Training Tables



Pa



Pb and Pc

Conference Tables



Pd



Pe and Pf



Pg and Ph

DOUBLE POWER BOX:

Conference Tables



Pd



Pe and Pf



Pg and Ph

MINI-OASIS POWER BOX:

Conference Tables



Pd



Pe and Pf



Pg and Ph

OASIS & POLY TROUGH:

Conference Tables



Pd



Pe and Pf



Pg and Ph



Add #0 to Model Code for this black plate. Add \$10 to power box list price.

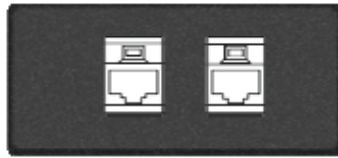

Add #1 to Model Code for this plate. Add \$160 to power box list price.

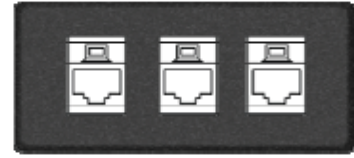

Add #2 to Model Code for this plate. Add \$235 to power box list price.

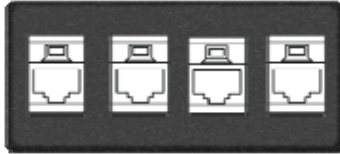

Add #3 to Model Code for this black plate. Add \$310 to power box list price.



Add #4 to Model Code for this plate. Add \$260 to power box list price.



Add #5 to Model Code for this plate. Add \$330 to power box list price.

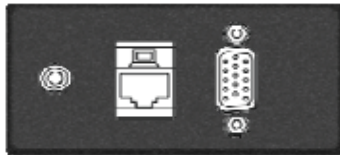

Add #6 to Model Code for this black plate. Add \$225 to power box list price.



Add #7 to Model Code for this plate. Add \$300 to power box list price.



Add #8 to Model Code for this plate. Add \$265 to power box list price.

BUILD YOUR OWN AV PLATE

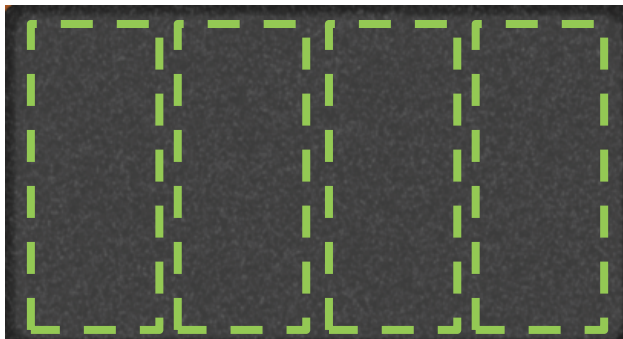

Each AV Plate has 4 zones.

Each jack below shows how many zones the jack takes up in space.



Data Jack
\$80 list per jack
Also Called:
Network jack,
Technical Info:
RJ45 CAT6
(Siemens Brand)



VGA - 2 zones
\$135 list per jack
Also Called:
Projector jack
Technical Info:
15 PIN F/F VGA
jack with male
patch cord



Phone Jack
\$45 list per jack
Also Called:
Technical Info:
CAT3 RJ11



USB - 2 zones
\$65 list per jack
Technical Info:
USB A/A with
patch cord
(NOTE: Active
Powered USB
ports are \$105
list each and
transformer kit
and patch cables.



Audio Jack
\$15 list per jack
Technical Info:
Mini Inline
Stereo jack



HDMI Jack
\$170 list per jack
Also Called:
Technical Info:
HDMI F/F with
male patch cord



DVI - 3 zones
\$260 list per jack
Technical Info:



Shown: Regular Box
with Cord manager
AV plate-\$35 list



POWER UNITS NOT SOLD SEPARATELY

5 VILLA USB – 2 OUTLETS PER BOX

August 1, 2014 Price List (Rev. A)



VILLA USB

RECOMMENDED FOR:

Laptop Tables, Training, Nesting, Mobile and Lecture Hall Tables

Specs: Two part unit comes in black or silver powder coat. Unit has two power outlets and two 2.1 Amp USB powered ports with outside flange dimensions are 3.39" x 5.68" x 2.25".

Non-linking: Power box wired for circuit 1 with 72" long soft wired 15 AMP corded plug and includes a 3rd convenience outlet under the table. All table tops include power box cut outs and are pre-drilled. Some assembly required..

Linking: Power boxes cannot link more than 8 units per circuit. Linking boxes are wired for either circuit 1 or circuit 2 with metal flexible conduit interconnecting cables that mount to the underside of the top and terminate at the ends of the top. Specify the quantity and style of feeder cables required. All table tops include power box cut outs and are pre-drilled. Some assembly required.

Understanding the Model Code :

PVUSB = Power Villa

B = Black / S = Silver

1 = 2 data jacks included

NON-LINKING

Step #1 – Add QTY of power box to power model code

Model Code	QTY of Outlets	QTY of USB Outlets	QTY of Data Jacks	Wired for Circuit	Color of Grommet	List Price
PVUSB B	2	2	0	1	Black	\$425
PVUSB S	2	2	0	1	Silver	\$425
PVUSB B1	2	2	2	1	Black	\$535
PVUSB S1	2	2	2	1	Silver	\$535

Step #2 – List grommet location code in description

Grommet location code choice:

Training Tables



Pa



Pb

Pc

POWER UNITS NOT SOLD SEPARATELY

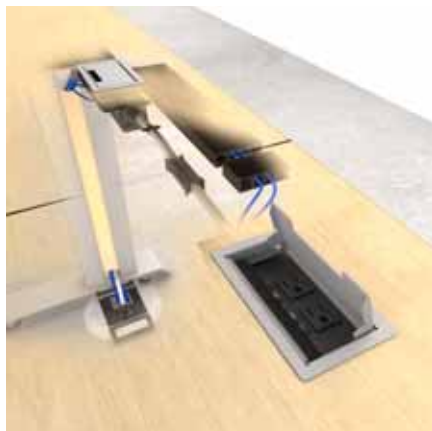

Understanding the Model Code :
 PVUSB = Power Villa
 L = Linking
 1 or 2 = Circuit #
 B = Black / S = Silver
 1 = 2 data jacks included

LINKING

Step #1 – Add QTY of power box to power model code

Model Code	QTY of Outlets	QTY of USB Outlets	QTY of Data Jacks	Wired for Circuit QTY	Color of Grommet	List Price
PVUSBL1B	2	2	0	1	Black	\$700
PVUSBL2B	2	2	0	2	Black	\$700
PVUSBL1S	2	2	0	1	Silver	\$700
PVUSBL2S	2	2	0	2	Silver	\$700
PVUSBL1B 1	2	2	2	1	Black	\$745
PVUSBL2B 1	2	2	2	2	Black	\$745
PVUSBL1S 1	2	2	2	1	Silver	\$745
PVUSBL2S 1	2	2	2	2	Silver	\$745

Step #2 – List grommet location code in description

Step #3 – On a separate line item on Order – List QTY of feeder cables

If power source is not located on the end of row, see the TEE-MMF below.

Model Code	Description	Black Cord or Metal Flex Conduit	List Price
PSTS48F	48" soft wire feeder cable (1 circuit systems)	24" Corded & 24" Metal Flex-comes with End Connector Cap	\$185
PSTS72F	72" soft wire feeder cable (1 circuit systems)	24" Corded & 24" Metal Flex-comes with End Connector Cap	\$185
PSTH48F	48" hard wire feeder cable (1 or 2 circuit systems)	Metal Flex Conduit - comes with End Connector Cap	\$125
PSTH72F	72" hard wire feeder cable (1 or 2 circuit systems)	Metal Flex Conduit - comes with End Connector Cap	\$125
PSTQ48F	48" quick disconnect feeder cable (1 or 2 circuit systems)	Metal Flex Conduit - comes with End Connector Cap	\$125
PSTQ72F	72" quick disconnect feeder cable (1 or 2 circuit systems)	Metal Flex Conduit - comes with End Connector Cap	\$125

Step #4 – On a separate line item on Order – List optional hardware

Model Code	Description	Black Cord or Metal Flex Conduit	List Price
When you select PSTQ48F or PSTQ72F from above, specify the QD-INSERT for your walls or floors.			
QD-INSERT	Insert for wall or floor mounted plate, junction boxes and decorative decora plates not included		\$85
When you power from the center of a row, specify TEE-MMF below along with your feeder cables from above.			
TEE-MMF	Daisy T used to power from center of row of tables (The male/male/female connector comes with 1 longer FF cable & 1 Male Feeder Cable is exchanged with Female)		\$200
When you connect a feeder cable from the right (female) side of table, specify PA12MM below along with your feeder cables from above.			
PA12MM	12" long non-directional male/male adaptor cable	Metal Flex Conduit - comes with End Connector Cap	\$115
PA12FF	12" long non-directional female/female adaptor cable	Metal Flex Conduit - comes with End Connector Cap	\$115

POWER UNITS NOT SOLD SEPARATELY

5 VILLA POWER – 2 OUTLETS PER BOX

August 1, 2014 Price List (Rev. A)

VILLA

RECOMMENDED FOR:

Laptop Tables, Training, Nesting, Mobile and Lecture Hall Tables

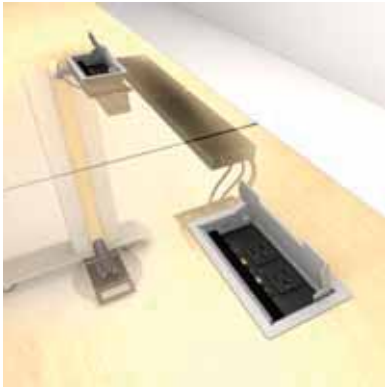

Specs: Two part unit comes in black or silver powder coat. Unit has 2 power outlets with outside flange dimensions are 3.39" x 5.68" x 2.25".

Non-linking: Power box wired for circuit 1 with 72" long soft wired 15 AMP corded plug and includes a 3rd convenience outlet under the table. All table tops include power box cut outs and are pre-drilled. Some assembly required. Other cord lengths available are 36" and 108" lengths.

Linking: Power boxes cannot link more than 8 units per circuit. Linking boxes are wired for either circuit 1 or circuit 2 with metal flexible conduit interconnecting cables that mount to the underside of the top and terminate at the ends of the top. Specify the quantity and style of feeder cables required. All table tops include power box cut outs and are pre-drilled. Some assembly required.

Understanding the Model Code :

PV = Power Villa

B = Black / S = Silver

1 = 2 data jacks included

2 = A/V Unit

NON-LINKING

Step #1 – Add QTY of power box to power model code

Model Code	QTY of Outlets	QTY of Data Jacks	QTY of F/F VGA Jacks	QTY of F/F Mini-Stereo	Wired for Circuit	Color of Grommet	List Price
PVB	2	0	0	0	1	Black	\$290
PVS	2	0	0	0	1	Silver	\$290
PVB1	2	2	0	0	1	Black	\$400
PVS1	2	2	0	0	1	Silver	\$400
PVB2	2	1	1	1	1	Black	\$480
PVS2	2	1	1	1	1	Silver	\$480



NON-LINKING VILLA PLUS

Model Code	QTY of Outlets on Top	QTY of Outlets under Top	QTY of Data Jacks	Wired for Circuit	Color of Grommet	List Price
PVPB	2	2	0	1	Black	\$360
PVPS	2	2	0	1	Silver	\$360
PVPB1	2	2	2	1	Black	\$470
PVPS1	2	2	2	1	Silver	\$470

Step #2 – List grommet location code in description

Grommet location code choice:

Training Tables



POWER UNITS NOT SOLD SEPARATELY

Understanding the Model Code :

- PV = Power Villa
- L = Linking
- 1 or 2 = Circuit #
- B = Black / S = Silver
- 1 = 2 data jacks included
- 2 = A/V Unit

LINKING
Step #1 – Add QTY of power box to power model code

Model Code	QTY of Outlets	QTY of Data Jacks	QTY of VGA Jacks	QTY of Mini-Stereo	Wired for Circuit QTY	Color of Grommet	List Price
PVL1B	2	0	0	0	1	Black	\$565
PVL2B	2	0	0	0	2	Black	\$565
PVL1S	2	0	0	0	1	Silver	\$565
PVL2S	2	0	0	0	2	Silver	\$565
PVL1B 1	2	2	0	0	1	Black	\$610
PVL2B 1	2	2	0	0	2	Black	\$610
PVL1S 1	2	2	0	0	1	Silver	\$610
PVL2S 1	2	2	0	0	2	Silver	\$610
PVL1B 2	2	1	1	1	1	Black	\$690
PVL2B 2	2	1	1	1	2	Black	\$690
PVL1S 2	2	1	1	1	1	Silver	\$690
PVL2S 2	2	1	1	1	2	Silver	\$690

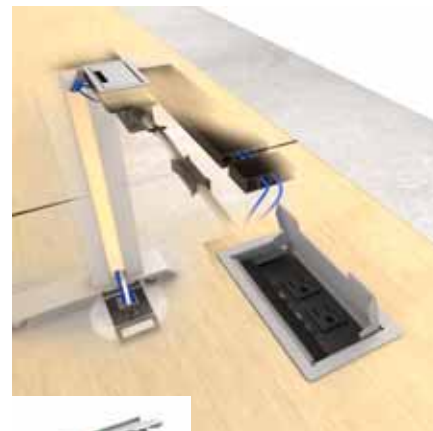

Model Code	QTY of Outlets on Top	QTY of Outlets under Top	QTY of Data Jacks	Wired for Circuit	Color of Grommet	List Price
PVPL1B	2	2	0	1	Black	\$635
PVPL2B	2	2	0	2	Black	\$635
PVPL1S	2	2	0	1	Silver	\$635
PVPL2S	2	2	0	2	Silver	\$635
PVPL1B 1	2	2	2	1	Black	\$680
PVPL2B 1	2	2	2	2	Black	\$680
PVPL1S 1	2	2	2	1	Silver	\$680
PVPL2S 1	2	2	2	2	Silver	\$680

Villa Plus Linking

Step #2 – List grommet location code in description
Step #3 – On a separate line item on Order – List QTY of feeder cables

If power source is not located on the end of row, see the TEE-MMF below.

Model Code	Description	Black Cord or Metal Flex Conduit	List Price
PSTS48F	48" soft wire feeder cable (1 circuit systems)	24" Corded & 24" Metal Flex-comes with End Connector Cap	\$185
PSTS72F	72" soft wire feeder cable (1 circuit systems)	24" Corded & 24" Metal Flex-comes with End Connector Cap	\$185
PSTH48F	48" hard wire feeder cable (1 or 2 circuit systems)	Metal Flex Conduit - comes with End Connector Cap	\$125
PSTH72F	72" hard wire feeder cable (1 or 2 circuit systems)	Metal Flex Conduit - comes with End Connector Cap	\$125
PSTQ48F	48" quick disconnect feeder cable (1 or 2 circuit systems)	Metal Flex Conduit - comes with End Connector Cap	\$125
PSTQ72F	72" quick disconnect feeder cable (1 or 2 circuit systems)	Metal Flex Conduit - comes with End Connector Cap	\$125

Step #4 – On a separate line item on Order – List optional hardware

Model Code	Description	Black Cord or Metal Flex Conduit	List Price
When you select PSTQ48F or PSTQ72F from above, specify the QD-INSERT for your walls or floors.			
QD-INSERT	Insert for wall or floor mounted plate, junction boxes and decorative decora plates not included		\$85
When you power from the center of a row, specify TEE-MMF below along with your feeder cables from above.			
TEE-MMF	Daisy T used to power from center of row of tables (The male/male/female connector comes with 1 longer FF cable & 1 Male Feeder Cable is exchanged with Female)		\$200

When you connect a feeder cable from the right (female) side of table, specify PA12MM below along with your feeder cables from above.

PA12MM	12" long non-directional male/male adaptor cable	Metal Flex Conduit - comes with End Connector Cap	\$115
PA12FF	12" long non-directional female/female adaptor cable	Metal Flex Conduit - comes with End Connector Cap	\$115

POWER UNITS NOT SOLD SEPARATELY

#5 VILLA UNDER TABLE – 2 OUTLETS PER BOX

August 1, 2014 Price List (Rev. A)



VILLA UNDER TABLE

RECOMMENDED FOR:
Laptop Tables, Training, Nesting, and Mobile

Specs: One power bar unit comes in black powder coat. Power bar has 2 power outlets.

Non-Linking: Power box wired for circuit 1 with 72" long soft wired 15 AMP corded plug and includes a 3rd convenience outlet under the table. All table tops are pre-drilled. Some assembly required.

Linking: Power boxes cannot link more than 8 units per circuit. Linking boxes are wired for either circuit 1 or circuit 2 with metal flexible conduit interconnecting cables that mount to the underside of the top and terminate at the ends of the top. Specify the quantity and style of feeder cables required. All table tops are pre-drilled. Some assembly required.

Understanding the Model Code :
PVU = Power Villa Under Table Only
B = Black
1 = 2 data jacks included
2 = A/V Unit

NON-LINKING

Step #1 – Add QTY of power box to power model code

Model Code	QTY of Outlets	QTY of Data Jacks	QTY of VGA Jacks	QTY of Mini-Stereo	Wired for Circuit	List Price
PVUB	2	0	0	0	1	\$210
PVUB 1	2	2	0	0	1	\$320
PVUB 2	2	1	1	1	1	\$405

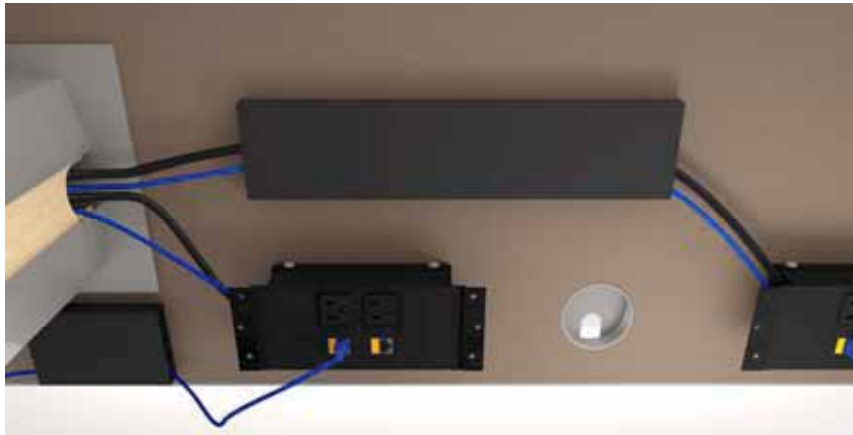

POWER UNITS NOT SOLD SEPARATELY



Understanding the Model Code :
 PVU = Power Villa Under Table Only
 L = Linking
 1 or 2 = Circuit #
 B = Black
 1 = 2 data jacks included
 2 = A/V Unit

LINKING

Step #1 – Add QTY of power box to power model code

Model Code	QTY of Outlets	QTY of Data Jacks	QTY of VGA Jacks	QTY of Mini-Stereo	Wired for Circuit	List Price
PVUL1B	2	0	0	0	1	\$420
PVUL2B	2	0	0	0	2	\$420
PVUL1B 1	2	2	0	0	1	\$530
PVUL2B 1	2	2	0	0	2	\$530
PVUL1B 2	2	1	1	1	1	\$615
PVUL2B 2	2	1	1	1	2	\$615

Step #2 – On a separate line item on Order – List QTY of feeder cables

If power source is not located on the end of row, see the TEE-MMF below.

Model Code	Description	Black Cord or Metal Flex Conduit	List Price
PSTS48F	48" soft wire feeder cable (1 circuit systems)	24" Corded & 24" Metal Flex-comes with End Connector Cap	\$185
PSTS72F	72" soft wire feeder cable (1 circuit systems)	24" Corded & 24" Metal Flex-comes with End Connector Cap	\$185
PSTH48F	48" hard wire feeder cable (1 or 2 circuit systems)	Metal Flex Conduit - comes with End Connector Cap	\$125
PSTH72F	72" hard wire feeder cable (1 or 2 circuit systems)	Metal Flex Conduit - comes with End Connector Cap	\$125
PSTQ48F	48" quick disconnect feeder cable (1 or 2 circuit systems)	Metal Flex Conduit - comes with End Connector Cap	\$125
PSTQ72F	72" quick disconnect feeder cable (1 or 2 circuit systems)	Metal Flex Conduit - comes with End Connector Cap	\$125

Step #3 – On a separate line item on Order – List optional hardware

Model Code	Description	List Price
------------	-------------	------------

When you select PSTQ48F or PSTQ72F from above, specify the QD-INSERT for your walls or floors.

QD-INSERT	Insert for wall or floor mounted plate, junction boxes and decorative decora plates not included	\$85
-----------	--	------

When you power from the center of a row, specify TEE-MMF below along with your feeder cables from above.

TEE-MMF	Daisy T used to power from center of row of tables (The male/male/female connector comes with 1 longer FF cable & 1 Male Feeder Cable is exchanged with Female)	\$200
---------	--	-------

When you connect a feeder cable from the right (female) side of table, specify PA12MM below along with your feeder cables from above.

PA12MM	12" long non-directional male/male adaptor cable	Metal Flex Conduit - comes with End Connector Cap	\$115
PA12FF	12" long non-directional female/female adaptor cable	Metal Flex Conduit - comes with End Connector Cap	\$115

POWER UNITS NOT SOLD SEPARATELY



Understanding the Model Code :
 PP = Power PAK
 Circuit #
 # of Power Outlets
 S = Starter Table / A = Add-On Table
 S = Soft Wired / Hard Wired

POWER PAK

RECOMMENDED FOR:
CPU Tables

Specs: Unit has 4 power outlets with outside flange dimensions are 11.37" wide x 4.5" tall x 2.37" deep. Can not link more than 3 units per circuit. A 96" long starter cable comes with the starter table. The Add-on tables come with metal flexible connecting cables that reach from one power unit to the next.



AV Plates-See Page 21

Black AV plates come with jacks as shown



Add #0 to Model Code for this plate. Add \$10 to list price.



Add #1 to Model Code for this plate. Add \$160 to list price.



Add #2 to Model Code for this plate. Add \$235 to list price.



Add #3 to Model Code for this plate. Add \$310 to list price.



Add #4 to Model Code for this plate. Add \$260 to list price.



Add #5 to Model Code for this plate. Add \$330 to list price.



Add #6 to Model Code for this plate. Add \$225 to list price.



Add #7 to Model Code for this plate. Add \$300 to list price.



Add #8 to Model Code for this plate. Add \$265 to list price.

LINKING

Step #1 – Add QTY of power box to power model code

Model Code	QTY of #1 Outlets	QTY of #2 Outlets	QTY of #3 Outlets	QTY of #4 Outlets	Starter or Add-on-Table	Soft Wired / Hard Wired	QTY of AV Plates	List Price of w/o A/V Plates
PP14-SS	4	0	0	0	Starter	Soft Wired	2	\$330
PP14-SH	4	0	0	0	Starter	Hard Wired	2	\$330
PP14A	4	0	0	0	Add-On	N/A	2	\$330
PP24A	0	4	0	0	Add-On	N/A	2	\$330
PP34A	0	0	4	0	Add-On	N/A	2	\$330
PP44A	0	0	0	4	Add-On	N/A	2	\$330

Step #2 – Add AV plates to power model code

POWER UNITS NOT SOLD SEPARATELY

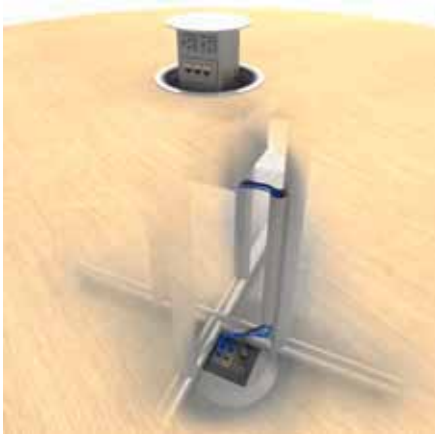

CONCEPT RECOMMENDED FOR: Round Tables

Specs: Two part unit comes in black or stainless steel. Unit has 4 power outlets with outside flange dimensions are 6" diameter x 14.5" deep.

Non-linking: Power box wired for circuit 1 with 72" long soft wired 20 AMP corded plug and includes a 3rd convenience outlet under the table. All table tops include power box cut outs and are pre-drilled. Some assembly required.

Understanding the Model Code :
PC = Power Concept
B = Black
SS = Stainless Steel

LINKING

Step #1 – Add QTY of power box to power model code

Model Code	QTY of Outlets	QTY of 72" Corded 15 AMP 3 Pronged Plug	Wired for Circuit #	Color or Grommet	QTY of AV Plates	List Price of PWR Box w/o AV Plates
PCB	4	1	1	Black	2	\$1080

Step #2 – List grommet location code in description

Step #3 – Add AV plates to power model code

Step #4 – List length of feeder cable(s) in description if other than 72" long

AV Plates-See Page 21

Black AV plates come with jacks as shown



Add #0 to Model Code for this plate. Add \$10 to list price.



Add #1 to Model Code for this plate. Add \$160 to list price.



Add #2 to Model Code for this plate. Add \$235 to list price.



Add #3 to Model Code for this plate. Add \$310 to list price.



Add #4 to Model Code for this plate. Add \$260 to list price.

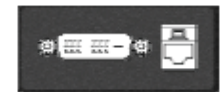

Add #5 to Model Code for this plate. Add \$330 to list price.



Add #6 to Model Code for this plate. Add \$225 to list price.



Add #7 to Model Code for this plate. Add \$300 to list price.



Add #8 to Model Code for this plate. Add \$265 to list price.

5 REGULAR POWER – 2 OUTLETS PER BOX

August 1, 2014 Price List (Rev. A)

REGULAR

RECOMMENDED FOR:

Training, Meeting or Conference Tables with limited AV needs

Specs: Drop in table top unit comes in black or silver powder coat. Unit has 2 power outlets with outside flange dimensions are 5.34" x 8.98".

Non-linking: Power box wired for circuit 1 with 72" long soft wired 15 AMP corded plug and includes a 3rd convenience outlet under the table. All table tops include power box cut outs and are pre-drilled. Some assembly required.

Linking: Power boxes can not link more than 8 units per circuit. Linking boxes are wired for either circuit 1 or circuit 2 with metal flexible conduit interconnecting cables that come from bottom of unit and stretch to next the unit. Specify the quantity and style of feeder cables required. All table tops include power box cut outs and are pre-drilled. Some assembly required.



Understanding the Model Code :
 PR = Power Regular
 B = Black / S = Silver
 4 = 4 Outlets
 1 = 4 Data Jacks

NON-LINKING

Step #1 – Add QTY of power box to table model code

Model Code	QTY of Outlets	QTY of 72" Corded 15 AMP 3 Pronged Plug	Wired for Circuit #	Color of Grommet	QTY of AV Plates	List Price of PWR Box w/o AV Plates
PRB	2	1	1	Black	1	\$300
PRS	2	1	1	Silver	1	\$300
PRB4	4	1	1	Black	0	\$300
PRS4	4	1	1	Silver	0	\$300
PRB4 1	4	1	1	Black	0*	\$300
PRS4 1	4	1	1	Silver	0*	\$300

*Note: PRB4 1 and PRS4 1 come with 4 data jacks.
 All PRB4 and PRS4 units do not include an outlet on the bottom of the unit.

Step #2 – List grommet location code in description

Step #3 – Add AV plates to power model code

Step #4 – List length of feeder cable(s) in description if other than 72" long

96" Length Upcharge is \$50
 108" Length Upcharge is \$50
 144" Length Upcharge is \$50



AV Plates-See Page 21

Black AV plates come with jacks as shown



Add #0 to Model Code for this plate. Add \$10 to list price.



Add #1 to Model Code for this plate. Add \$160 to list price.



Add #2 to Model Code for this plate. Add \$235 to list price.



Add #3 to Model Code for this plate. Add \$310 to list price.



Add #4 to Model Code for this plate. Add \$260 to list price.



Add #5 to Model Code for this plate. Add \$330 to list price.



Add #6 to Model Code for this plate. Add \$225 to list price.



Add #7 to Model Code for this plate. Add \$300 to list price.



Add #8 to Model Code for this plate. Add \$265 to list price.

Grommet location code choice:

Training Tables



Pa



Pb

Pc

Conference Tables



Pd



Pe

Pf



Pg

Ph

POWER UNITS NOT SOLD SEPARATELY

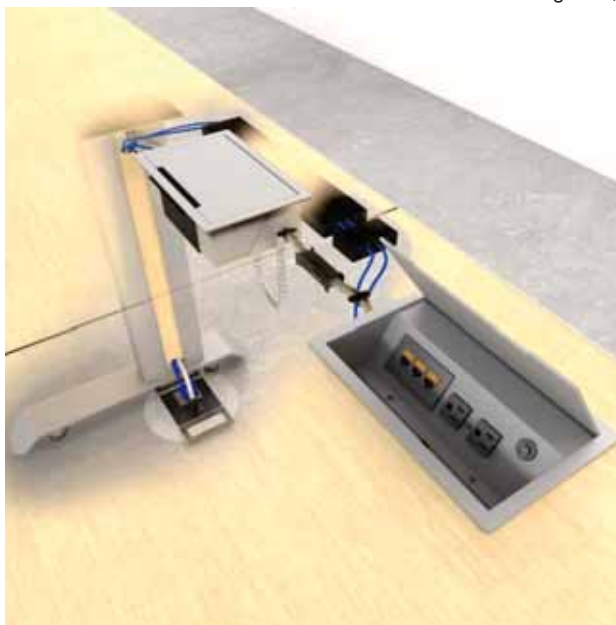

Understanding the Model Code :
 PR = Power Regular
 B = Black / S = Silver
 1 or 2 = Circuit
 L = Linking

LINKING

Step #1 – Add QTY of power box to table model code

Model Code	QTY of Outlets	QTY of AV Plates	Wired for Circuit #	Color of Grommet	List Price of PWR Box w/o AV Plates
PRL1B	2	1	1	Black	\$655
PRL2B	2	1	2	Black	\$655
PRL1S	2	1	1	Silver	\$675
PRL2S	2	1	2	Silver	\$675

Step #2 – List grommet location code in description

Step #3 – Add AV plates to power model code

Step #4 – On a separate line item on Order – List QTY of feeder cables

If power source is not located on the end of row, see the TEE-MMF below.

Model Code	Description	Black Cord or Metal Flex Conduit	List Price
PSTS48F	48" soft wire feeder cable (1 circuit systems)	24" Corded & 24" Metal Flex-comes with End Connector Cap	\$185
PSTS72F	72" soft wire feeder cable (1 circuit systems)	24" Corded & 24" Metal Flex-comes with End Connector Cap	\$185
PSTH48F	48" hard wire feeder cable (1 or 2 circuit systems)	Metal Flex Conduit - comes with End Connector Cap	\$125
PSTH72F	72" hard wire feeder cable (1 or 2 circuit systems)	Metal Flex Conduit - comes with End Connector Cap	\$125
PSTQ48F	48" quick disconnect feeder cable (1 or 2 circuit systems)	Metal Flex Conduit - comes with End Connector Cap	\$125
PSTQ72F	72" quick disconnect feeder cable (1 or 2 circuit systems)	Metal Flex Conduit - comes with End Connector Cap	\$125

Step #5 – On a separate line item on Order – List optional hardware

Model Code	Description	List Price
------------	-------------	------------

When you select PSTQ48F or PSTQ72F from above, specify the QD-INSERT for your walls or floors.

QD-INSERT	Insert for wall or floor mounted plate, junction boxes and decorative decora plates not included	\$85
-----------	--	------

When you power from the center of a row, specify TEE-MMF below along with your feeder cables from above.

TEE-MMF	Daisy T used to power from center of row of tables (The male/male/female connector comes with 1 longer FF cable & 1 Male Feeder Cable is exchanged with Female)	\$200
---------	--	-------

When you connect a feeder cable from the right (female) side of table, specify PA12MM below along with your feeder cables from above.

PA12MM	12" long non-directional male/male adaptor cable	Metal Flex Conduit - comes with End Connector Cap	\$115
PA12FF	12" long non-directional female/female adaptor cable	Metal Flex Conduit - comes with End Connector Cap	\$115

POWER UNITS NOT SOLD SEPARATELY

5 LARGE POWER – 4 OUTLETS PER BOX

August 1, 2014 Price List (Rev. A)



LARGE

RECOMMENDED FOR:

Training, Meeting or Conference Tables with moderate AV needs

Specs: Drop in table top unit comes in black or silver powder coat. Unit has 4 power outlets with outside flange dimensions are 6.68" x 14.27".

Non-Linking: Power box wired for circuit 1 with 72" long soft wired 15 AMP corded plug and includes a 3rd convenience outlet under the table. All table tops include power box cut outs and are pre-drilled. Some assembly required.

Understanding the Model Code :

PL = Power Large
B = Black / S = Silver
H = Hard Wired

NON-LINKING

Step #1 – Add QTY of power box to power model code

Model Code	QTY of Outlets	Soft Wired or Hardwired	Wired for Circuit #	Color of Grommet	QTY of AV Plates	List Price of PWR Box w/o AV Plates
PLB	4	Soft Wired	1	Black	4	\$720
PLS	4	Soft Wired	1	Silver	4	\$720
PLBH	4	Hard Wired	1	Black	4	\$720
PLSH	4	Hard Wired	1	Silver	4	\$720

Step #2 – List grommet location code in description

Step #3 – Add AV plates to power model code [See page 20 for AV Plate options]

Step #4 – List length of feeder cable(s) in description if other than 72" long

96" Length	Upcharge is \$50
108" Length	Upcharge is \$50
144" Length	Upcharge is \$50

Grommet location code choice:

Training Tables

Conference Tables



Pa



Pb

Pc



Pd



Pe

Pf



Pg

Ph

POWER UNITS NOT SOLD SEPARATELY

AV Plates-See Page 21

Black AV plates come with jacks as shown



Add #0 to Model Code for this plate. Add \$10 to list price.



Add #1 to Model Code for this plate. Add \$160 to list price.



Add #2 to Model Code for this plate. Add \$235 to list price.



Add #3 to Model Code for this plate. Add \$310 to list price.



Add #4 to Model Code for this plate. Add \$260 to list price.



Add #5 to Model Code for this plate. Add \$330 to list price.



Add #6 to Model Code for this plate. Add \$225 to list price.



Add #7 to Model Code for this plate. Add \$300 to list price.



Add #8 to Model Code for this plate. Add \$265 to list price.

DOUBLE

RECOMMENDED FOR:

Training, Meeting or Conference Tables with moderate AV needs



Specs: Drop in table top unit comes in black or silver powder coat. Unit has 4 power outlets with outside flange dimensions are 11.46" x 14.27".

Non-linking: Power box wired for circuit 1 with 72" long soft wired 15 AMP corded plug and includes a 3rd convenience outlet under the table. All table tops include power box cut outs and are pre-drilled. Some assembly required.

Understanding the Model Code :

PD = Power Double
B = Black / S = Silver
H = Hard Wired

NON-LINKING

Step #1 – Add QTY of power box to power model code

Model Code	QTY of Outlets	Soft Wired or Hardwired	Wired for Circuit #	Color of Grommet	QTY of AV Plates	List Price of PWR Box w/o AV Plates
PDB	8	Soft Wired	1	Black	8	\$1170
PDS	8	Soft Wired	1	Silver	8	\$1170
PDBH	8	Hard Wired	1	Black	8	\$1170
PDSH	8	Hard Wired	1	Silver	8	\$1170

Step #2 – List grommet location code in description

Step #3 – Add AV plates to power model code [See page 20 for AV Plate options]

Step #4 – List length of feeder cable(s) in description if other than 72" long

96" Length Upcharge is \$50
108" Length Upcharge is \$50
144" Length Upcharge is \$50

AV Plates-See Page 21

Black AV plates come with jacks as shown



Add #0 to Model Code for this plate. Add \$10 to list price.



Add #1 to Model Code for this plate. Add \$160 to list price.



Add #2 to Model Code for this plate. Add \$235 to list price.



Add #3 to Model Code for this plate. Add \$310 to list price.



Add #4 to Model Code for this plate. Add \$260 to list price.



Add #5 to Model Code for this plate. Add \$330 to list price.



Add #6 to Model Code for this plate. Add \$225 to list price.



Add #7 to Model Code for this plate. Add \$300 to list price.



Add #8 to Model Code for this plate. Add \$265 to list price.

Grommet location code choice:

Conference Tables



Pd



Pe

Pf



Pg

Ph

POWER UNITS NOT SOLD SEPARATELY

5 MINI OASIS – 4, 6, or 8 OUTLETS PER BOX

August 1, 2014 Price List (Rev. A)

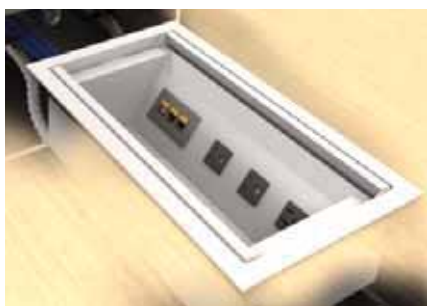

Understanding the Model Code :
 PM = Power Mini Oasis
 B = Black / S = Silver
 4, 6, 8 = # of Outlets Per Box

MINI OASIS

RECOMMENDED FOR:
Conference Tables with moderate AV needs

Specs: Drop in table top unit comes in black or silver powder coat. Unit has 4, 6 or 8 power outlets with outside flange dimensions are 9" x 15".

Non-linking: Power box wired for circuit 1 soft wired 15 AMP 108" corded plug and includes a steel pan under the table. All table tops include power box cut outs and are pre-drilled. Some assembly required.

Linking: Power boxes can not link more than 3 units per circuit. Linking boxes are wired for either circuit 1 or circuit 2 with metal flexible conduit interconnecting cables that come from bottom of unit and stretch to next the unit. Specify the quantity and style of feeder cables required. All table tops include power box cut outs and are pre-drilled. Some assembly required.

NON-LINKING

Step #1 – Add QTY of power box to power model code

Model Code	QTY of Outlets	QTY of 108" Corded 15 AMP 3 Pronged Plug	Wired for Circuit #	Color of Grommet	QTY of AV Plates	List Price of PWR Box w/o AV Plates
PMB4	4	1	1	Black	3	\$1615
PMS4	4	1	1	Silver	3	\$1615
PMB6	6	2	1	Black	2	\$1615
PMS6	6	2	1	Silver	2	\$1615
PMB8	8	2	1	Black	0	\$1615
PMS8	8	2	1	Silver	0	\$1615

Step #2 – List grommet location code in description

Step #3 – Add AV plates to power model code [See page 20 for AV Plate options]

Step #4 – List length of feeder cable(s) in description if other than 108" long

96" Length Upcharge is \$50
 144" Length Upcharge is \$50

Grommet location code choice:

Conference Tables



Pd



Pe

Pf



Pg

Ph

POWER UNITS NOT SOLD SEPARATELY

AV Plates-See Page 21

Black AV plates come with jacks as shown



Add #0 to Model Code for this plate. Add \$10 to list price.



Add #1 to Model Code for this plate. Add \$160 to list price.



Add #2 to Model Code for this plate. Add \$235 to list price.

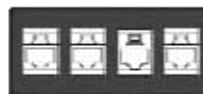

Add #3 to Model Code for this plate. Add \$310 to list price.



Add #4 to Model Code for this plate. Add \$260 to list price.



Add #5 to Model Code for this plate. Add \$330 to list price.



Add #6 to Model Code for this plate. Add \$225 to list price.



Add #7 to Model Code for this plate. Add \$300 to list price.



Add #8 to Model Code for this plate. Add \$265 to list price.

Understanding the Model Code :

PM = Power Mini Oasis

L = Linking

1 or 2 = Circuit #

B = Black / S = Silver

4, 6, 8 = # of Outlets in Box

S = Starter Table / A = Add-On Table

S = Soft Wired / H = Hard Wired / Q = Quick Disconnect

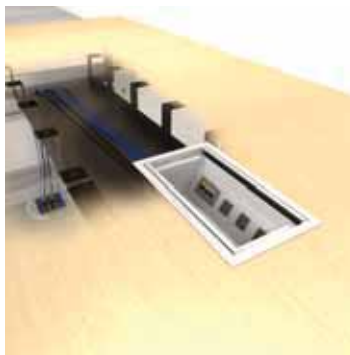

LINKING

Step #1 – Add QTY of power box to table model code

Model Code	QTY of Outlets	Starter or Add-On Table	108" Soft Wired / Hard Wired or Interconnecting Cables	Wired for Circuit #	Color of Grommet	QTY of AV Plates	List Price of PWR Box w/o AV Plates
PML1B4SS	4	Starter	Soft Wired	1	Black	3	\$2010
PML1B4SH	4	Starter	Hard Wired	1	Black	3	\$2010
PML1B4SQ	4	Starter	Quick Disconnect	1	Black	3	\$2010
PML1B4A	4	Add-On	Interconnecting Cables	1	Black	3	\$1950
PML2B4A	4	Add-On	Interconnecting Cables	2	Black	3	\$1950
PML1B4SS	4	Starter	Soft Wired	1	Silver	3	\$2010
PML1B4SH	4	Starter	Hard Wired	1	Silver	3	\$2010
PML1B4SQ	4	Starter	Quick Disconnect	1	Silver	3	\$2010
PML1B4A	4	Add-On	Interconnecting Cables	1	Silver	3	\$1950
PML2B4A	4	Add-On	Interconnecting Cables	2	Silver	3	\$1950
PML1B6SS	6	Starter	Soft Wired	1	Black	2	\$2010
PML1B6SH	6	Starter	Hard Wired	1	Black	2	\$2010
PML1B6SQ	6	Starter	Quick Disconnect	1	Black	2	\$2010
PML1B6A	6	Add-On	Interconnecting Cables	1	Black	2	\$1950
PML2B6A	6	Add-On	Interconnecting Cables	2	Black	2	\$1950
PML1B6SS	6	Starter	Soft Wired	1	Silver	2	\$2010
PML1B6SH	6	Starter	Hard Wired	1	Silver	2	\$2010
PML1B6SQ	6	Starter	Quick Disconnect	1	Silver	2	\$2010
PML1B6A	6	Add-On	Interconnecting Cables	1	Silver	2	\$1950
PML2B6A	6	Add-On	Interconnecting Cables	2	Silver	2	\$1950
PML1B8SS	8	Starter	Soft Wired	1	Black	0	\$2010
PML1B8SH	8	Starter	Hard Wired	1	Black	0	\$2010
PML1B8SQ	8	Starter	Quick Disconnect	1	Black	0	\$2010
PML1B8A	8	Add-On	Interconnecting Cables	1	Black	0	\$1950
PML2B8A	8	Add-On	Interconnecting Cables	2	Black	0	\$1950
PML1B8SS	8	Starter	Soft Wired	1	Silver	0	\$2010
PML1B8SH	8	Starter	Hard Wired	1	Silver	0	\$2010
PML1B8SQ	8	Starter	Quick Disconnect	1	Silver	0	\$2010
PML1B8A	8	Add-On	Interconnecting Cables	1	Silver	0	\$1950
PML2B8A	8	Add-On	Interconnecting Cables	2	Silver	0	\$1950

Step #2 – List grommet location code in description

Step #3 – Add AV plates to power model code [See page 20 for AV Plate options]

Step #4 – On a separate line item on Order – List optional hardware

Model Code	Description	List Price
When you select PSTQ48F or PSTQ72F from above, specify the QD-INSERT for your walls or floors.		
QD-INSERT	Insert for wall or floor mounted plate, junction boxes and decorative decora plates not included	\$85
When you power from the center of a row, specify TEE-MMF below along with your feeder cables from above.		
TEE-MMF	Daisy T used to power from center of row of tables (The male/male/female connector comes with 1 longer FF cable & 1 Male Feeder Cable is exchanged with Female)	\$200
When you connect a feeder cable from the right (female) side of table, specify PA12MM below along with your feeder cables from above.		
PA12MM	12" long non-directional male/male adaptor cable	Metal Flex Conduit - comes with End Connector Cap \$115
PA12FF	12" long non-directional female/female adaptor cable	Metal Flex Conduit - comes with End Connector Cap \$115

POWER UNITS NOT SOLD SEPARATELY

5 OASIS – 8, 12, or 16 OUTLETS PER BOX

August 1, 2014 Price List (Rev. A)



OASIS

RECOMMENDED FOR:
Conference Tables with AV needs

Specs: Drop in table top unit comes in black or silver powder coat. Unit has 8, 12 or 16 power outlets with outside flange dimensions are 9" x 30".

Non-Linking: Power box wired for circuit 1 soft wired 15 AMP corded plug and includes a steel pan under the table. All table tops include power box cut outs and are pre-drilled. Some assembly required.

Linking: Power boxes can not link more than 2 units per circuit. Linking boxes are wired for either circuit 1 or circuit 2 with metal flexible conduit interconnecting cables that come from bottom of unit and stretch to next the unit. Specify the quantity and style of feeder cables required. All table tops include power box cut outs and are pre-drilled. Some assembly required.

Understanding the Model Code :
PO = Power Oasis
B = Black / S = Silver
8, 12, 16 = # of Outlets Per Box

NON-LINKING

Step #1 – Add QTY of power box to power model code

Model Code	QTY of Outlets	QTY of 108" Corded 15 AMP 3 Pronged Plug	Wired for Circuit #	Color of Grommet	QTY of AV Plates	List Price of PWR Box w/o AV Plates
POB8	8	2	1	Black	6	\$2650
POS8	8	2	1	Silver	6	\$2650
POB12	12	4	1	Black	4	\$2650
POS12	12	4	1	Silver	4	\$2650
POB16	16	4	1	Black	0	\$2650
POS16	16	4	1	Silver	0	\$2650

Step #2 – List grommet location code in description

Step #3 – Add AV plates to power model code [See page 20 for AV Plate options]

Step #4 – List length of feeder cable(s) in description if other than 108" long

96" Length Upcharge is \$50
144" Length Upcharge is \$50

Grommet location code choice:

Conference Tables



Pd



Pe

Pf



Pg

Ph

POWER UNITS NOT SOLD SEPARATELY

AV Plates-See Page 21

Black AV plates come with jacks as shown

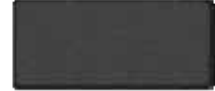

Add #0 to Model Code for this plate. Add \$10 to list price.



Add #1 to Model Code for this plate. Add \$160 to list price.



Add #2 to Model Code for this plate. Add \$235 to list price.



Add #3 to Model Code for this plate. Add \$310 to list price.



Add #4 to Model Code for this plate. Add \$260 to list price.



Add #5 to Model Code for this plate. Add \$330 to list price.



Add #6 to Model Code for this plate. Add \$225 to list price.



Add #7 to Model Code for this plate. Add \$300 to list price.



Add #8 to Model Code for this plate. Add \$265 to list price.

Understanding the Model Code :

- PO = Power Oasis
- L = Linking
- 1 or 2 = Circuit #
- B = Black / S = Silver
- 8, 12, 16 = # of Outlets per Box
- S = Starter Table / A = Add-On Table
- S = Soft Wired / H = Hard Wired / Q = Quick Disconnect

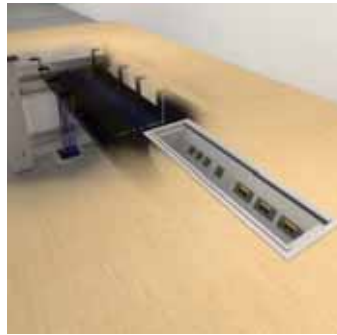

LINKING

Step #1 – Add QTY of power box to power model code

Model Code	QTY of Outlets	Starter or Add-On Table	Soft Wired / Hard Wired or Interconnecting Cables	Wired for Circuit #	Color of Grommet	QTY of AV Plates	List Price of PWR Box w/o AV Plates
POL1B8SS	8	Starter	Soft Wired	1	Black	6	\$3385
POL1B8SH	8	Starter	Hard Wired	1	Black	6	\$3385
POL1B8SQ	8	Starter	Quick Disconnect	1	Black	6	\$3385
POL1B8A	8	Add-On	Interconnecting Cables	1	Black	6	\$3330
POL2B8A	8	Add-On	Interconnecting Cables	2	Black	6	\$3330
POL1B8SS	8	Starter	Soft Wired	1	Silver	6	\$3385
POL1B8SH	8	Starter	Hard Wired	1	Silver	6	\$3385
POL1B8SQ	8	Starter	Quick Disconnect	1	Silver	6	\$3385
POL1B8A	8	Add-On	Interconnecting Cables	1	Silver	6	\$3330
POL2B8A	8	Add-On	Interconnecting Cables	2	Silver	6	\$3330
POL1B12SS	12	Starter	Soft Wired	1	Black	4	\$3385
POL1B12SH	12	Starter	Hard Wired	1	Black	4	\$3385
POL1B12SQ	12	Starter	Quick Disconnect	1	Black	4	\$3385
POL1B12A	12	Add-On	Interconnecting Cables	1	Black	4	\$3330
POL2B12A	12	Add-On	Interconnecting Cables	2	Black	4	\$3330
POL1B12SS	12	Starter	Soft Wired	1	Silver	4	\$3385
POL1B12SH	12	Starter	Hard Wired	1	Silver	4	\$3385
POL1B12SQ	12	Starter	Quick Disconnect	1	Silver	4	\$3385
POL1B12A	12	Add-On	Interconnecting Cables	1	Silver	4	\$3330
POL2B12A	12	Add-On	Interconnecting Cables	2	Silver	4	\$3330
POL1B16SS	16	Starter	Soft Wired	1	Black	0	\$3385
POL1B16SH	16	Starter	Hard Wired	1	Black	0	\$3385
POL1B16SQ	16	Starter	Quick Disconnect	1	Black	0	\$3385
POL1B16A	16	Add-On	Interconnecting Cables	1	Black	0	\$3330
POL2B16A	16	Add-On	Interconnecting Cables	2	Black	0	\$3330
POL1B16SS	16	Starter	Soft Wired	1	Silver	0	\$3385
POL1B16SH	16	Starter	Hard Wired	1	Silver	0	\$3385
POL1B16SQ	16	Starter	Quick Disconnect	1	Silver	0	\$3385
POL1B16A	16	Add-On	Interconnecting Cables	1	Silver	0	\$3330
POL2B16A	16	Add-On	Interconnecting Cables	2	Silver	0	\$3330

Step #2 – List grommet location code in description

Step #3 – Add AV plates to power model code [See page 20 for AV Plate options]

POWER UNITS NOT SOLD SEPARATELY

PAGE INTENTIONALLY LEFT BLANK

Replace the ?? with the size of table to complete the model code. [ex. ML36 – is for a Laminated modesty panel on a 36” long table.]



PERFORATED METAL MODESTY PANEL

9” High, 20 gauge steel with a durable powder coat finish. Available in black or silver. Modesty panels are free swinging on all tables. Not available on folding tables. Modesty panel and the underside of the table top are predrilled. Attachment Hardware and assembly instructions are included for field installation. Ganging plate and screws provided for tables longer than 72”.

Model Code: MM??

30” table	\$185 list price	48” table	\$230 list price	For 84” tables spec two 42” panels	\$450 list price
36” table	\$190 list price	60” table	\$245 list price	For 96” tables spec two 48” panels	\$460 list price
42” table	\$225 list price	72” table	\$265 list price		



LAMINATED MODESTY PANEL

9” High, .75” thick particle board. Finished with laminate both sides and all edges. Modesty panel and the underside of the table top are predrilled. Attachment Hardware and assembly instructions are included for field installation.

Model Code: ML??

30” table	\$210 list price	48” table	\$250 list price	For 84” tables spec two 42” panels	\$480 list price
36” table	\$230 list price	60” table	\$270 list price	For 96” tables spec two 48” panels	\$500 list price
42” table	\$240 list price	72” table	\$300 list price		



WOOD VENEER MODESTY PANEL

9” High, .75” thick particle board finished with wood veneer both sides and all edges. Not available on folding tables. Modesty panel and the underside of the table top are predrilled. Attachment Hardware and assembly instructions are included for field installation.

Model Code: MV??

30” table	\$440 list price	48” table	\$490 list price	For 84” tables spec two 42” panels	\$960 list price
36” table	\$450 list price	60” table	\$610 list price	For 96” tables spec two 48” panels	\$980 list price
42” table	\$480 list price	72” table	\$630 list price		



FLEXIBLE METAL MODESTY PANEL - PERFORATED

14” High, .22 gauge steel flexible modesty panel. Panels feature .18” diameter perforated holes centered every 3” and a durable powder coat finish. Available in black or silver. Modesty panels are inset 2” from each edge. Contact Factory for continuous panels. Modesty panel and the underside of the table top are predrilled. Attachment Hardware and assembly instructions are included for field installation.

Model Code: MMC??

30” table	\$280 list price	48” table	\$340 list price	For 84” tables spec two 42” panels	\$640 list price
36” table	\$300 list price	60” table	\$380 list price	For 96” tables spec two 48” panels	\$680 list price
42” table	\$320 list price	72” table	\$400 list price		



FLEXIBLE LAMINATED MODESTY PANEL – NONPERFORATED

14” High, .25” thick flexible modesty panel. Face of panel is finished with high pressure laminate, back and edges are black. Modesty panels are inset 2” from each edge. Contact Factory for continuous panels. Attachment Hardware and assembly instructions are included for field installation.

Model Code: MLC??

30” table	\$300 list price	48” table	\$360 list price	84” table	\$680 list price
36” table	\$320 list price	60” table	\$400 list price	96” table	\$720 list price
42” table	\$340 list price	72” table	\$420 list price		



FLEXIBLE WOOD VENEER MODESTY PANEL - PERFORATED

14” High, .25” thick flexible modesty panel. Face of panel is finished with vertical grain wood veneer and features .25” diameter perforated holes centered every 2”. Back and edges are black. Modesty panels are inset 2” from each edge. Contact Factory for continuous panels. Attachment Hardware and assembly instructions are included for field installation.

Model Code: MWC??

30” table	\$540 list price	48” table	\$590 list price	84” table	\$1160
36” table	\$550 list price	60” table	\$710 list price	96” table	\$1180
42” table	\$580 list price	72” table	\$730 list price		

Lead Times: 4 - 6 weeks laminate table | 6 - 8 weeks for wood edged tables | 8-10 weeks for wood veneer tables and customs

Finishes: Pages 4-9 | Power: Pages 21-38 | Options: Pages 39-49



VERTICAL ABS PLASTIC WIRE MANAGEMENT - ROUND

Half round shaped 2.68" x 1", combination of rigid and flexible PVC, vertical wire management. Heavy duty self-adhesive sticky tape is pre-installed on hinged edges of 22" long piece which allows track to conform easily to curved surface. Available in Black or Silver. Field Installed.

Model Code: WVB (black) or WVS (silver) \$25 list price per base

VERTICAL ABS PLASTIC WIRE MANAGEMENT - RECTANGLE

Rectangle shaped 1" x 2", combination of rigid and flexible PVC, vertical wire management. Heavy duty self-adhesive sticky tape is pre-installed on hinged edges of 22" long piece which allows track to conform easily to surface. Available in Black or Silver. Field Installed.

Model Code: WRB (black) or WRS (silver) \$25 list price per base



VERTICAL LASER CUT HOLE WIRE MANAGEMENT

1.5" x 2.5" holes cut in top and bottom of column to feed wire(s) in and out of base.

Model Code: WB \$50 list price per base



aFIX ROUND BASE VERTICAL WIRE MANAGEMENT

3" diameter column with 1.5" round holes cut in top and bottom of column to allow wire(s) to feed in and out of column. Holes are located approximately 2.5" from top of the base and 2.5" from floor. Wire(s) can be ran directly into the bottom of base, wire bundle must fit within a 2.5" diameter area.

Model Code: WB \$50 list price per base



aFIX ROUND STEEL FLOOR COVER

7.5" round X 1.375" high steel bottom cover plate powder-coated Black or Silver. Cover plate is free spinning, designed to sit over standard black ABS plastic molded plate.

Model Code: AXPC \$130 list price per base



aFIX BOAT-SHAPE BASE VERTICAL WIRE MANAGEMENT

The aFix Base was designed with wire management in mind, features a 3.625" x 8" boat-shaped column with 3.5" wide x 2" high openings in top of column to feed wire(s) into base with a 1.875" wide x 3.875" long opening through column to feed wire(s) down to the floor.



HORIZONTAL WIRE MANAGEMENT TRACK

3" x .75" 4-channel wire management track, a co-extrusion with rigid sides and a softer top. Each channel is .75" x .625". In the center of each channel is a slot which has a memory, so it closes back up. Sold in 36" lengths, easily cut to desired length in the field. Features two strips of factory installed double sided tape on each 36" piece. Field Installed.

Model Code: WH \$80 list price per piece



HORIZONTAL CONFERENCE WIRE MANAGEMENT TROUGH

12" wide x 34" long x 6" high 18 gage steel track, with eight 6" access holes, powder coated black. Attachment hardware and installation instructions are included. Field installed.

Model Code: WT \$475 list price per trough



METAL MODESTY PANEL WIRE MANAGEMENT J-CHANNEL

16 gage x 3.5" high x 2.37" deep horizontal J-Channel that hangs on free swinging perforated metal modesty panel. J-Channel simply clips into modesty panel slots, no hardware required. Sits 4.75" below bottom of top. Available in black or silver powder coat. Field Installed.

Model Code: WJ \$210 list price per piece

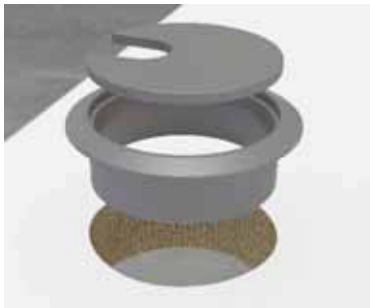

ROUND WIRE MANAGEMENT GROMMET

2.5" round abs plastic grommet. Tables are drilled out at factory for correct hole size. Insert and cap ship loose and are easily installed, no hardware required. Field installed.

Model code: GS (silver) or GB (black) \$20 list price each



RECTANGLE WIRE MANAGEMENT GROMMET

3" x 5.5" flush mount rectangle powder coated steel grommet. Tables are drilled out at factory for correct hole size. Available in black or silver. Easily installed with two screws to hold securely in place. Field installed.

Model code: GVS (silver) or GVB (black) \$120 list price

CUSTOMER SPECIFITED HOLE OR SPECIAL SHAPE

A custom hole may be specified. A customer supplied template for the hole is required.

Model Code: CNC \$250 List set up fee per template

#5 WIRE MANAGEMENT OPTION SPECS

August 1, 2014 Price List (Rev. A)



CAPITOL WIRE MANAGEMENT

The Capitol Base was designed with CPU storage and wire management access in mind. Each unit features hinged doors at each end with an opening of 10.25" wide and 19.5" tall. Inside top edges of the base features 5" wide x 1.5" tall notches to allow pass through of wire(s) from base to base or top to base. Bottom of the base features a 5" x 8" opening to access floor receptacle. Opening at top of base allows a regular power box to be mounted directly over base, larger power boxes should be offset of base or Contact Factory for a customized base quote.



CANYON WIRE MANAGEMENT

All Canyon Bases come standard with two 2" diameter wire management holes located 3" to center of hole from top edge of base, on opposite sides of base to accommodate pass through of wire(s) from base to base or top to base. Optional wire management access door is 8" wide x 10" high and is located starting 2" above bottom of base below one of the wire management holes. Door features a 1" x .75" finger pull and is attached with Velcro to allow easy access of wire(s) and floor receptacle. The 18" bases feature 12" openings in top and bottom and can accommodate up to a regular power box. The 24" bases feature 18" openings in top and bottom and can accommodate up to a Double power box or Mini Oasis.

Model Code: ADCN

\$300 list price per door for Canyon bases



RAILWAY WIRE MANAGEMENT

The Railway Base is the ultimate wire management base, featuring removable doors and opening size to accommodate any size power box or trough, any number of wires or conduit, and floor receptacles.



UNION WIRE MANAGEMENT

The Union Base features our 3" wide four-channel extruded PVC wire management track, flush mounted down center of the panel. End panels feature track running full length of one side of panel - 27". Center panels feature 21" of track recessed in panel on one side centered below a 13.75" wide x 5.75" high notch for accommodating power boxes. Accommodates all power boxes except for the Poly Through. Factory Installed.

Model Code: WM

\$100 list price per Union base



TABLE GANGER

3.5" diameter 2-piece zinc die-cast table ganger. Simply twist and lock in place. See page 19 for possible configurations and location codes. Sold in sets, which consists of two gangers, four pieces. Attached with #10 x 3/4" screws. Factory installed.

Not available on solid surface table tops or wood edged table tops.
Not available on knife edge profiles.

Model code: TG-LOCATION \$135 list price per set/table



QUICK RELEASE PLATE

Constructed of 11 gage heavy duty steel, the 3" x 6" quick release plates are designed for supporting pie/quarter round shaped tops without a base or ganging larger tables. Simply loosen the hand knobs, slide tables together, tighten hand knobs and tops are joined level and secure. The low profile knob eliminates any conflict between the user and the release mechanism. Inserts are factory installed, plate and knobs are field installed. Plate has a black powder coat finish, knobs are rigid molded plastic.

Available on solid surface table tops and wood edged table tops.
Not available on knife edge profiles.

Model Code: QR \$100 list price each plate



MUTIPLE PIECE TABLES

Tables in multiple pieces require a field joint. Field joints have routed special shaped cut-outs on bottom of top and a grooved edge and use connector bolts and spline material to join tops together. Spline material is inserted into edge to guide and hold pieces together, the connector bolt is inserted into cut-out and tightened until seam is level and tight. Connector bolt is zinc plated, high carbon steel, 3.5" long, threaded about .75" of its length, with 1" cross pieces. Spline material is .125" hardboard cut in 1" widths and various lengths, dependent on table size. Field Installed.

Model Code: FJ \$300 list price each additional joint on tables 10' and under.
*No Up-Charge, standard on tables longer than 10'



FLAT PLATES

3" x 6", .125" thick fixed flat plates are used to provide additional leveling and support on multiple piece tops where there is no base support. Black powder coat finish. Plate, screws, and installation instructions are provided. Field installed.

Model Code: FP \$20 list price each plate



ANTI-SAG BARS

12 gage fabricated steel bar attached to underside of table top. 2" wide, black powder coat finish. Factory installed.

Model code: AS \$100 list price each bar
*Standard on tower collection 60", 66", and 72" tables.



CPU HOLDER - FIXED UNIT

Securely clamps and holds CPU, steel with black epoxy finish. Height adjustment of 13.375" - 20.5".

Model Code: C1 - Width adjustment of 5.5" - 9.25" \$180 List Price Ea
Model Code: C2 - Width adjustment of 2.75" - 5.25" \$180 List Price Ea



CPU HOLDER - SWIVEL UNIT

Securely clamps and holds CPU, steel with black epoxy finish. Height adjustment of 13.375" - 20.5", 360 degrees of swivel and 8.5" of travel provide easy access to connections on the rear of CPU.

Model Code: C3 - Width adjustment of 5.5" - 9.25" \$290 List Price Ea
Model Code: C4 - Width adjustment of 2.75" - 5.25" \$290 List Price Ea



DIVIDER / PRIVACY PANELS

.5" thick clear frosted acrylic panels are 16" high and feature polished edges and through mount hardware. Tops are provided with pre-drilled holes. Assembly instructions are provided. Field Installed.

Model Code: DPA??

Replace the ?? with the size of panel to complete the divider panel model code. [ex. DPA36 – is for a 36" long diver panel.]

24" panel	\$720 list price	48" panel	\$1385 list price	84" panel	\$2620 list price
30" panel	\$970 list price	60" panel	\$1495 list price	96" panel	\$2625 list price
36" panel	\$1025 list price	66" panel	\$1550 list price		
42" panel	\$1380 list price	72" panel	\$1905 list price		



COBY APRON BASE - FORMED CLUTCH HOOKS

The Coby apron base features 1" x 1" x 12 gauge formed steel clutch hooks. The hooks are formed at a 45 degree angle and strategically placed dependent on table length. Clutch Hooks come standard with Coby Apron Base tables.



CAPITOL BASE INSERTS

Capitol inserts are decorative and functional! Constructed of 18 gauge perforated steel, flush mounted and finished with durable powder coat. See page 5 for available powder coat colors. For additional type of inserts, Contact Factory.

Model Code: DIP \$200 list price per base and includes both sides of base



METAL TO METAL CONNECTION

A metal to metal connection is recommended for tables that are dis-assembled and assembled often as the particle board core may weaken and cause stability issues with the bases. 1/4-20 Brass inserts are factory installed and 1/4-20 x 3/4" screws are provided for field installation of bases. Inserts have fins on the outside diameter which provides higher pull-out resistance and prevents splintering and splitting.

Model Code: TI \$100 list price per table



SHARED LEG

Shared leg may be specified to increase leg space and reduce number of bases. This option is only recommended for stationary tables that have no plan of moving around. Tables will need to be ordered as starter tables and add-on tables in order to predrill tops properly for the bases.

Starter Table

Model Code: SSL

Pricing found under options for each individual collection.

Add-on Tables

Model Code: SAL

Pricing found under options for each individual collection.



ADD 3RD BASE TO TRAINING TABLE

Used for 84" - 96" long training tables. The option to add a 3rd base is dependent on the number and size of chairs being used. Two bases are standard and standard placement is 10"-12" from edge of tops, adding a base reduces the placement of the bases to 6" from each edge with 3rd base placed to allow maximum knee/leg space and keep the integrity of the strength of table.

Model Code: ABGY

Pricing found under options for the Gateway collection.

ABHR

Pricing found under options for the Harbor collection.

ABLY

Pricing found under options for the Liberty collection.

ABSP

Pricing found under options for the Supreme collection.



OCCASIONAL HEIGHT

Bar height is an overall table height of 18".

Model Code: SC

Pricing found under options for each individual collection.

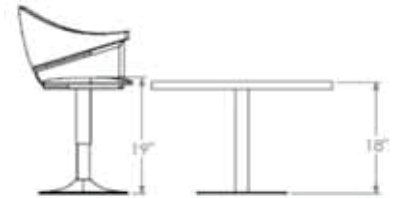

CAFE HEIGHT

Cafe height is an overall table height of 36". Model

Code: CH

Pricing found under options for each individual collection.

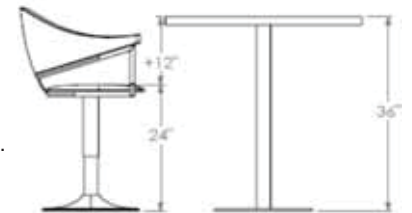

BAR HEIGHT

Bar height is an overall table height of 42".

Model Code: BH

Pricing found under options for each individual collection.

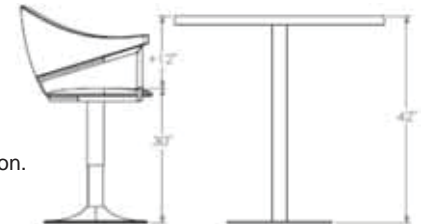

CUSTOM HEIGHT

Custom height is a required height that is shorter than or taller than standard 29" standard height and is not 36" cafe or 42" bar height.

Shorter than standard 29" height - Model Code: SC

Taller than standard 29" height - Model Code: TC

Pricing found under options for each individual collection. Specify overall table height desired.

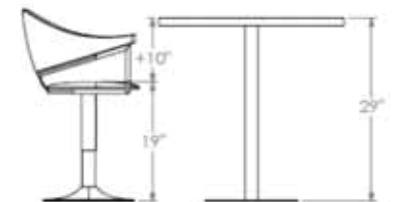

* Standard seat height shown above



RADIUS CORNERS

Radius Corners are available in 1", 2", 3", 4" or 5" radius. Due to the limitations of some edge profiles, please consult the factory for edge profile and radius recommendations.

Model Code: RC?

Contact Factory for pricing



PUSH BUTTON ADJUSTABLE HEIGHT

The push button adjustable height option is a spring-clip column that allows adjustments in 1" increments. Available in two different ranges and various collections. Available in the following collections: Gateway, Harbor, Liberty, Supreme, and Tower.

Table Height Range: 26" - 35"

C's, T's, and Post legs	Model Code :AHC1, AHT1, AHP1	List Price: \$160 each base
X-Base, Supreme only	Model Code: AHX1	List Price: \$220 each base
TT-Base, Supreme only	Model Code: AHTT	List Price: \$300 each base

Table Height Range: 29" - 42"

C's, T's, and Post legs	Model Code: AHBC1, AHBT1, AHBP1	List Price: \$220 each base
X-Base, Supreme only	Model Code: AHX1	List Price: \$280 each base
TT-Base, Supreme only	Model Code: AHTT	List Price: \$430 each base



HAND CRANK ADJUSTABLE HEIGHT

Adjustment at the turn of the handle. Available in the Liberty and the Empire collections

Empire - Screw thread adjustment with infinite stop positions. Adjust with manual crank handle at a rate of 6-1/3 turns per inch (4mm pitch). Table height range of 9.5", 27.25" - 36.75". Handle slides under table when not in use. Maximum lifting load of 180 pounds for single column and 225 pounds for two columns, maximum of three (3) columns adjusted from one crank handle. Option for Locking Casters is available which adds 2" to starting height.

Liberty - Adjust with manual crank handle at a rate of 5 turns per inch. Table height range of 13.5", 27.25" - 40.75". Handle folds when not in use and can be mounted on front of table or on top of table. Maximum lifting load of 150 pounds for single column and 300 pounds for two column units. Custom configurations with up to four (4) legs all adjusting from one crank handle. Call factory with requests. Available options include: Flip top (X-Base only) and Locking Casters. Locking Casters add 2" to starting height.



PNEUMATIC ADJUSTABLE HEIGHT

Pneumatic adjustment with easy lever release. Available in the Empire Collection only.

Pneumatic cylinder assist with infinite stop positions with no-bounce cylinder stop. Steel roller glide system. Unintentional-release resistant lever with cable release. Table height range of 17.7", 27.25"h to 45"h. Range Lifting force of forty four (44) pounds standard. Additional lifting forces are available, Contact Factory for information. Available options include Flip-top and Locking Casters. Locking Casters add 2" to starting height.



ELECTRIC ADJUSTABLE HEIGHT

Electric motor adjustment at the touch of a switch. Available in the Liberty and Empire collections

Empire - Infinite stop positions with adjustment speed of 1.97" per second (50mm/sec). Two table height ranges to choose from: 19.69" of range, 27.25"h to 46.94"h or 26" of range, 22.25"h to 48.25"h. Simple up and down buttons, control up to 12 columns from a single keypad. Maximum lifting force of 225 pounds for two columns. Options and accessories include: Built-in Key pad w/display, Built-in memory keypad with display, key pad cable extensions, motor cable extensions, Link Cables, and safety sensors.

Liberty - Table height range of 15.75", 27.25"h to 43"h. Maximum lifting force of 300 pounds for two columns. Locking Casters are available, which adds 2" to starting height.



FOLDING MECHANISM

Construction consists of an injected molded body, aluminum pivot, steel locking blade, and rubber bumper pad. Features a rigid wedge-locking design eliminating movement and a single lever that locks and releases mechanism. Folding rectangle tables under 60" and all round folding require bracket(s) for a leg over leg construction. Factory installed.



FOLDING TABLE LEG OVER LEG BRACKET

The bracket raises one of the legs of the table so that it will overlap the other leg and fold into the storage position. Aluminum construction, black anodized finish. Two pieces per table are required, (four when used with double T bases), Factory installed.

Tables are not horizontally stackable with riser brackets.

Standard on all folding tables requiring leg over leg application

Model Code: FRC (C Leg) or FRT (T Leg)	\$90 list price (C or T leg)
FRTT	\$160 list price (TT leg)



RECTANGLE FOLDING TABLE CART

Folding Table Cart for Rectangle Tables up to 30 x 72 tables; Flat stack folding table cart. Holds up to 30" wide x 72" long tables. Overall cart dimensions are 74.5"L x 31.5"W x 38"H. Cart weighs 96 lbs. and is black powder coated steel. Each cart holds 4-6 tables. Factory recommends to add customer's own straps to keep tables secure.

Model Code: FC-72RE \$2700 list price

Folding Table Cart for Rectangle Tables up to 30 x 96 tables; Flat stack folding table cart. Holds up to 30" wide x 96" long tables. Overall cart dimensions are 105"L x 31.5"W x 38"H. Cart weighs 104 lbs. and is black powder coated steel. Each cart holds 4-6 tables. Factory recommends to add customer's own straps to keep tables secure.

Model Code: FC-96RE \$2780 list price



ROUND FOLDING TABLE CART

Folding Table Cart for Round Tables up to 72" round; Edge stack folding table cart. Holds 48", 60" and 72" round folding tables. Overall dimensions are 38.5" wide x 32.75" length x 50" height. Cart weighs 56 lbs and is black powder coated steel. Each cart holds four-six tables. Factory recommends to add customer's own straps to keep tables secure.

Model Code: FC-Round \$2500 list price



ROUND & SQUARE FLIP TOP NESTING MECHANISM

Construction consists of 11 gauge stamped steel - Used on 42" and 48" flip-top nesting tables. Tops are predrilled for mechanism, field installed.

No Upcharge-Standard

Note: 42" square is maximum size available in the Gateway Collection.



ROUND & SQUARE FLIP TOP NESTING MECHANISM

Construction consists of an injected molded body, aluminum pivot, steel locking blade, and rubber bumper pad. Features a rigid wedge-locking design eliminating movement and a single lever that locks and releases mechanism. Used on flip-top nesting tables up to 36" square. Tops are predrilled for mechanism, field installed.

No Upcharge-Standard



DUAL FLIP TOP NESTING MECHANISM

Consists of two latch assemblies designed to latch table in setup position, lever arm designed to support top in flipped position. Latches and lever arm factory installed in recessed pockets in top. Mounting plates are 5" x 11" x .25" steel, Top and Base supports are two 5.5" wide aluminum extrusions, length dependent upon table size. Extrusions are finished with a black powder coat, latches and lever have a durable black epoxy finish to match.

No Upcharge-Standard on all dual flip top tables

COBY

Leveler: 1.25" diameter, 5/16-18" thread x 1" long stem, chrome plated rubber cushioned. Comes standard upon ordering

Caster: 60mm, locking twin hard-wheel designed for carpet, 5/16-18" thread, .5" stem, black with silver caps. Load capacity of 130 pounds per caster.

Model Code: CS, \$40 list price per Square-base, \$80 list price per Apron base.



EMPIRE

Leveler: 1.375" diameter, 5/16-18" thread x .5" stem. Comes standard upon ordering.

Caster: 2" diameter, locking twin hard-wheel designed for carpet, 5/16-18" thread, .5" stem, black. Load capacity of ??? pounds per caster.

Model Code: CS, \$40 list price per T-base, \$80 list price per X-Base



GATEWAY

Leveler: 1.375" diameter, 1/4-20" thread x .59" long stem, black polypropylene. Comes standard upon ordering

Caster: 60mm, locking twin hard-wheel designed for carpet, 3/8-16" thread, .5" stem, black.

Model Code: CS, \$40 list price per T-base, \$80 list price per X-Base.



HARBOR

Leveler: 1.375" diameter, 3/8-16" thread x .75" long stem, white polypropylene base with chrome steel cover. No Charge - Standard upon ordering.

Caster: 60mm, locking twin hard wheel designed for carpet, 3/8-16" thread, 1" long stem, black.

Model Code: CS, \$40 list price per T-base, \$80 list price per X-Base.



Hidden Wheel: 1.42" diameter x .5" wide, black polypropylene.

Model Code: WL, \$95 List per base.

ISLAND

Leveler: 1-3/8" diameter, 1/4-20" thread x 5/8" long stem, black polypropylene, adjustable. Positions base plate off floor approximately 1". Levelers are recommended for hard surface floors.

Model Code: LV, \$90 List per Base - Island bases are provided without levelers as standard.



SUPREME

Leveler: 1.375" diameter, 3/8-16" thread x .75" long stem, white polypropylene base with chrome steel cover. No Charge - Standard upon ordering

Caster: 2" diameter, locking hooded twin wheel designed for carpet, 3/8-16" thread, .5" stem, black. Load capacity of 110 pounds per caster.

Model Code: CS \$40 list price per T-base, \$80 list price per X-Base.



Leveler Extension: Can be added to change the appearance of the bases or used on the C, T, and Y bases to allow tables to be "wheel barrowed" around by putting extensions on one base and casters on the other base. Bases with leveler extensions and casters will have same column length and overall height. Aluminum, powder coated black with 1.88" diameter black plastic leveler, 3/8-16" thread, .75" stem. Height 1.90" tall.

Model Code: LE, \$60 list price per T-base, \$120 list price per X-Base.

Self-Leveling Glide

Self-adjusting hydraulic glide, 5/16" range of automatic movement, enclosed unit, safe on any floor. The small shock absorbers automatically adjust to any uneven floor surface and prevent your tables from wobbling. Stud length .30", raises table height approx. 1/2", available in thread sizes, 1/4-20", 5/16-18", and 3/8-16".

Model Code: SAG, \$200 List per table.



Accessory Options

Below are options that are available on all Accessories.



CREDENZA PULL OPTIONS:

- Pull #1 - Round Bar pull, steel, stainless steel look, .472" diameter x 8.189" tall.
- Pull #2 - Arched Bar pull, steel, dark oil-rubbed bronze, 6.02" tall.
- Pull #3 - Split Bar pull, zinc, polished chrome, 1.378" wide x 6.772" tall.
- Pull #4 - Square Bar pull, stainless steel, matte finish, .591" wide x 5.63" tall.
- Pull #5 - Flat Bar Pull, Zinc, silver aluminum finish, .315" tall x 6.693" wide
- Pull #6 - L-Shape extruded aluminum pull, silver matte anodized, .748" high x 6.614" wide.

MODEL CODE

- CD1
- CD2
- CD3
- CD4
- CD5
- CD6

LIST PRICE

- No Up-Charge
- No Up-Charge
- No Up-Charge
- No Up-Charge
- No Up-Charge
- No Up-Charge

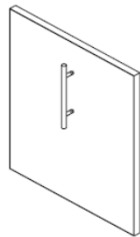

Pull #1

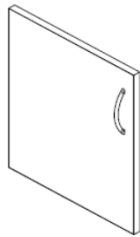

Pull #2

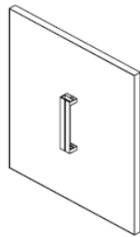

Pull #3

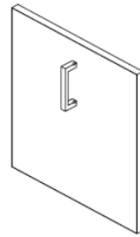

Pull #4

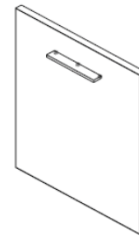

Pull #5

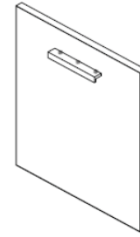

Pull #6

CREDENZA OPTIONS:

- Locking doors
- Custom Stain for wood edges or veneers
- Premium laminate upcharge
- AV Rack
- Louvered Panel
- Touch Latch

MODEL CODE

- LK,
- UCS
- UCL
- AVRACK
- CLP
- CTL

LIST PRICE

- \$200 per door
- \$600
- Contact Factory
- \$1850 per rack
- \$100 per panel
- \$115 per door

CREDENZA SPECS:

LOCKING CREDEZA DOORS - Disc Tumbler Cam Locks are offered for credenza doors. 90 degree cam turn, key removable in locked on unlocked position. Two keys are provided and are keyed alike. Specify one lock for every two doors.

LOUVERED PANEL - 20" x 16" 18 gage steel louvered panel. Louvers are 3" wide and spaced 4" center to center horizontally and 2" bottom to bottom vertically. Powder coated finish.

CREDENZA AV RACK - Rotating slide-out AV equipment rack simplifies equipment installation in cabinet and shortens installation and service time. Detachable rack frame also allows for off-site integration. Overall dimensions are 24"h x 19.25" deep with usable space of 21"h x 19" deep and a weight capacity of 125 lbs. Features include: integral cable management, ball bearing slides, 90 degree rotation ability for equipment servicing, ability to lock in extended and rotated positions, lockable (with included hardware), and a black brushed anodized finish.



Credenza
Louvered Panel



Credenza
AV Rack

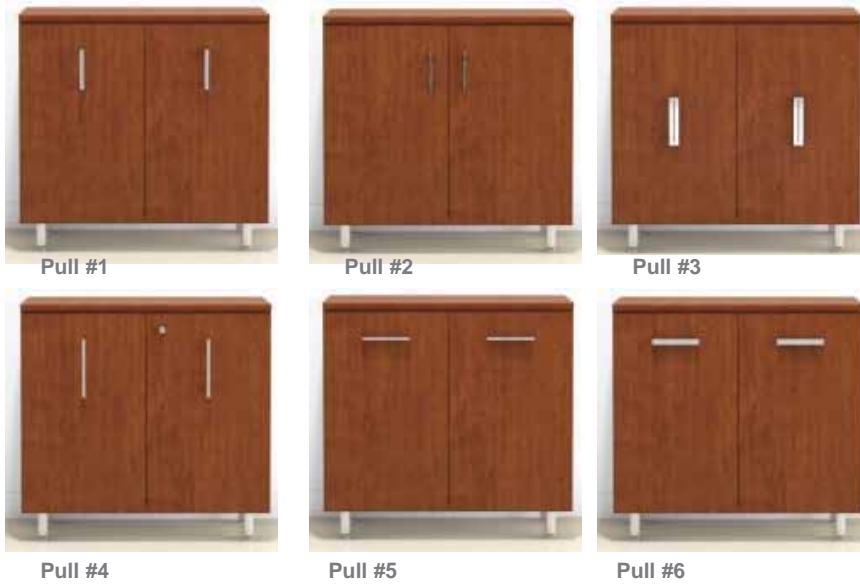

Laminate Credenzas			Veneer Credenzas	
L3	L5	L18	W16	W18
L6	L7	L20L30	W17	W20W30
	L10	L21L31		W21W31
	L11	L22L32		W22W32
	F1	L26		W26
	F2	L33		W33
		L34		W34
		L35		W35
		L37		W37

Laminate Body						
24 x 36 x 29h	C? 243629 L 2 door	3865	3915	4150	4280	4440
24 x 36 x 34h	C? 243634 L 2 door	3975	4025	4260	4390	4550
Wood Veneer Body						
24 x 36 x 29h	C? 243629 W 2 door	5590	6040	6275	6405	6565
24 x 36 x 34h	C? 243634 W 2 door	6295	6345	6580	6710	6870
Laminate Body						
24 x 53 x 29h	C? 245329 L 3 door	5225	5290	5825	6040	6310
24 x 53 x 34h	C? 245334 L 3 door	5360	5425	5960	6175	6445
Wood Veneer Body						
24 x 53 x 29h	C? 245329 W 3 door	8145	8210	8745	8960	9230
24 x 53 x 34h	C? 245334 W 3 door	8575	8640	9175	9390	9660
Laminate Body						
24 x 72 x 29h	C? 247229 L 4 door	6855	6935	7605	7865	8205
24 x 72 x 34h	C? 247234 L 4 door	7110	7190	7860	8120	8460
Wood Veneer Body						
24 x 72 x 29h	C? 247229 W 4 door	10,595	10,675	11,345	11,605	11,945
24 x 72 x 34h	C? 247234 W 4 door	11,390	11,470	12,140	12,400	12,740

Pull selection:

Replace the ? with the pull # to complete the model code.
 [ex. C3 243629 L - for a 24x36 2-door credenza with a #3 split bar pull]

All credenzas have fully finished backs and 4" tall black or chrome round feet.



#5 Accessories

Questions? 816-774-4050

August 1, 2014 Price List (Rev. A)



Mobile Lectern

Model Code: CC-LECTERN

\$2750 list price

19" d x 30" w x 48" high

Model Code: CC-LECTERN-FLAT

\$3150 list price

19" d x 30" w x 48" high

NOTE: This mobile lectern comes with either an angled top or a flat top.

NOTE: PS400 Power Strip with 4 outlets and 72" long cord (\$215 list)

Mobile White Board

Model Code: CC-WHITEBOARD

\$2570 list price

22" d x 41" w x 75" high

Mobile TV Cart

Model Code: CC-TV283469

\$2295 list price

28" d x 33.5" w x 69" high

NOTE: PS400 Power Strip with 4 outlets and 72" long cord (\$215 list)

Mobile AV Cart

Model Code: CC-AVCART

\$1315 list price

20" d x 26" w x 40" high

NOTE: PS400 Power Strip with 4 outlets and 72" long cord (\$215 list)



Presentation Board

Model Code: L48.L6 \$3500 list price for laminate

Model Code: V48.L6 \$4700 list price for wood veneer

4" d x 48" w x 48" high

Accessories

Questions? 816-774-4050

August 1, 2014 Price List (Rev. A)



Lectern shown on casters



Lectern shown with flip up shelf



Lectern shown with flip up shelf and power

Lectern - Laminate Body

Size	Model Code	List Price
20w x 24l x 48h	L202448L	3450
20w x 36l x 48h	L203648L	5200

Lectern - Veneer Body

Size	Model Code	List Price
20w x 24l x 48h	L202448W	3750
20w x 36l x 48h	L203648W	5900

LECTERN OPTIONS:

- Flip up Shelf (specify left or right side)
- Locking Casters
- Custom Stain
- Premium laminate upcharge
- Round Grommets (black)
- Round Grommets (silver)

MODEL CODE

- FS (L/R)
- CS
- UCS
- UCL
- GB
- GS

LIST PRICE

- \$350
- \$250
- \$400
- Contact Factory
- \$20 per grommet
- \$20 per grommet

LECTERN SPECS:

LECTERN FLIP-UP SHELF - 12"W x 15"D flip-up shelf. Shelf features multi-position 14 gage steel fold-away zinc plated bracket, and a .75" thick shelf that is finished to match lectern. Factory installed. Specify Left or Right side

MOBILE LECTERN - Add mobility to your lectern! Four 2.375" (60mm) black casters with silver caps on 2.375" x 2.375" steel swivel plates. Features two non-locking and two locking casters. Locking casters are located on user side of lectern for easy access. Load rating of 130 pounds per caster, factory installed.

POWERED LECTERN - Add Power to lectern - features Villa unit with two power receptacles, one data jack, one VGA jack, and one mini stereo. Removable inner shelf is notched to allow wires to pass through, a 2.5" wire management hole with black grommet is located on bottom fixed shelf to allow pass through of wires to power source.

aFIX

COLLECTION

aFix Collection

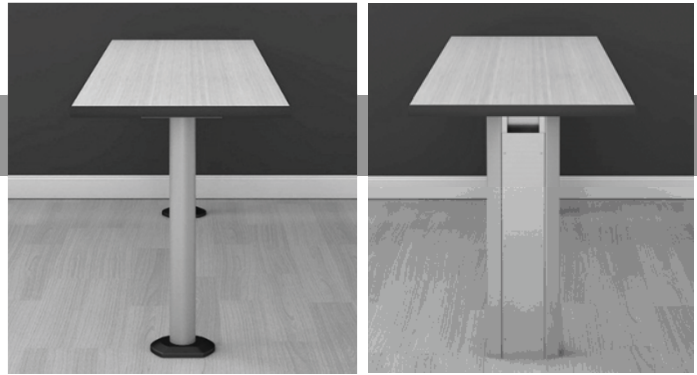

aFIX has two base options, straight or curved top shapes, and three modesty panel options. The 3" round base offers optional cord management holes for powered table installations. The 8" boat shaped base comes standard with interior raceway for cord management. All base mounting hardware is provided by the installation crew. The 3" round base comes standard with black plastic floor cover. aFIX bases are available in any standard Hi5 powder coat finish colors.

Laminate tops are available in any standard Wilsonart, Formica, Arborite, or Pionite laminate. Premium laminates are available but must be quoted by the factory. Any Hi5 standard edge option is available for aFIX table tops. Tops are constructed of 1.25" thick 45 lb. high-density particle board. Continuous table top joints are secured with draw bolts and flat plates. Table tops are predrilled for aFIX bases based on individual project parameters.

Modesty panels are available in metal, laminate, or veneer materials, and will align with the straight or curved table layout. Modesty panels are fastened together upon installation to create the appearance of a continuous panel. They are secured to the top with brackets and screws.

For information on power, data, AV and wire management options please refer to our power section pages 19-41.

FINISHES NEEDED TO ORDER:

Laminate Selection: Wilsonart, Formica, Arborite, Pionite

Edge Color: Any Hi5 standard

Base Finish: BK - Black (ABS plastic floor flange cover is black)

Modesty Panel: Silver or Black

Power Box Location Code: Custom

Power Box Color: Silver or Black

DEALERSHIP RESPONSIBLE FOR:

- Providing Hi5 all field measurements and verifications.
- Hi5 will provide generic drawings to work from.
- All finish sample verifications.
- Completion of electrician circuit dedication drawing provided by Hi5.
- Coordinating schedule of product delivery and install.
- Storage if product is delayed after manufacturer begins.
- Properly receiving and inspection of product.
- All deposits and payments regardless of contractual agreements with end user or contractor.
- Hi5 will provide one day of field measurement training & install training if requested.

TO REQUEST A QUOTE FROM Hi5 FOR aFIX PLEASE SUBMIT THE FOLLOWING INFORMATION:

1. CAD file of the room.
2. Seating capacity of room.
3. Are ADA tables required? If so, how many tables/seats are required and where are they located on the table layout?
4. Desired width for each seat.
5. If modesty panels are required, please specify material as metal, laminate, or veneer.
6. If power/data is required, please specify quantity of receptacles and AV/Data connections required per person.
7. Specify base style: 3" round base or boat shaped base.
8. Project name and anticipated installation date.

Contact Factory FOR LAYOUT, SIZE OPTIONS AND SPECIFICATION ASSISTANCE

aFIX LEG OPTIONS

See page 43 for specification information



aFIX round base with plastic cover – Standard
Model Code: AXP2



aFIX boat shaped base – Standard
Model Code: AXD8



aFIX round base with optional steel floor cover
Model Code: AXPC
* There is an upcharge associated with this item

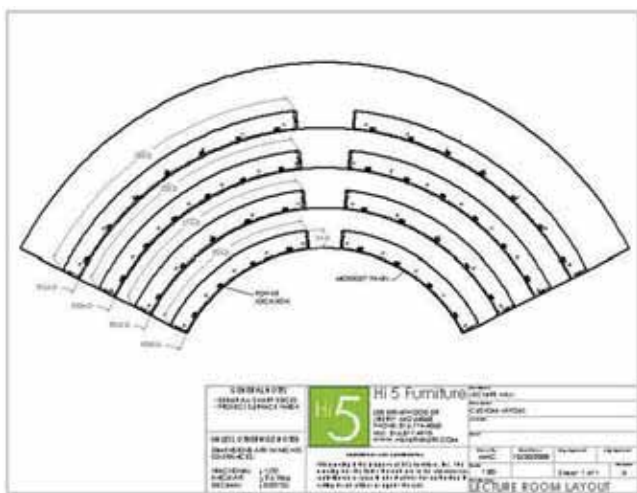

HI5 offers CAD files, field measurement assistance and installation assistance on all projects.

Canyon Options

Below are options that are available on all Canyon tables.



BASE OPTIONS: [page 45 for base heights]

- Café Height – 36" High
- Bar Height – 42"
- Alternate table height shorter than 29"
- Alternate table height taller than 29"

Access Door

TABLE OPTIONS:

- Custom Stain for wood edges and veneers
- Premium Laminate
- Premium Edge-banding

POWER & A/V OPTIONS : [page 21- 38]

- Non-powered round ABS plastic Grommet (black or silver) | List location code on page 18
- Non-powered rectangle metal Grommet (black or silver) | List location code on page 18

WIRE MANAGEMENT: [page 40 - 42]

- Customer specified hole cut into top
- Vertical ABS Leg Way for table base (black or silver)
- 36" long Horizontal 4 track Extruded Raceway
- 12" wide x 34" wide Horizontal Conference Trough
- J-channel that attaches to Metal Modesty Panel
- Wire Management access door

ACCESSORIES: [pages 39 - 49 for options]

- Make a 1-piece table top a 2-piece table top on tables 10' and under
- Flat Plates

MODEL CODE	LIST PRICE
CH	Contact Factory
BH	Contact Factory
SC	\$150 per table
TC – 24" & 30" tables	\$200 per table
TC - 36" tables	\$280 per table
AD	\$300 per base
UCS	\$600 per color
UCL	Contact Factory
UCE	Contact Factory
G (B/S)	\$20 per grommet
GV (B/S)	\$120 per grommet
CNC	\$250 set up fee per template
WVS/B	\$25 list per piece
HW	\$80 per piece
WT	\$475 list per Tray
WJ	\$210 list per table
ADCN	\$300 list price per door
FJ	\$300 for each additional joint
FP	\$20 per plate



Wire Management Access Door

CONTACT FACTORY FOR LAYOUT, SIZE OPTIONS AND SPECIFICATION ASSISTANCE

Example Base Product Code :						Finish Selections:		
<u>CN</u>	<u>CL</u>	<u>3060</u>	<u>RE</u>	<u>S</u>	<u>L3</u>	-	Options in	<u>BK</u>
Product Line	Base style	Top size	Top shape	Table function	Top edge		Alphabetical Order	Base Finish
								<u>7909-60</u>
								Top Laminate or Veneer Selection
								<u>BK</u>
								Edge Color



Round Top



Rectangle Top



Racetrack Top

How to Order:

Email orders to: sales@hi5furniture.com

1. Choose your base model
2. Add edge code to base model
3. Choose finishes
4. Select options to add to table
5. Select finishes of options

Racetrack or Boat Shaped Tables:

Replace the ? with an RT (for Racetrack) or a BT (for Boat) to complete the model code.
 [ex. CNCL 3660 BT - for a 36x60 boat]

Laminate & FormaWrap Tables

				Veneer
				Back Painted Glass
				Solid Surfaces

Table Size	Top Shape		Model Code:	Top QTY	Base QTY	Base Size						
48"	Round	HPL	CNCL 48RD S	1	1	24"	1990	2100	2855	3230	Contact	Factory
60"	Round	HPL	CNCL 60RD	1	1	30"	2540	2665	3925	4555	Contact	Factory
72"	Round	HPL	CNCL 72RD S	1	1	36"	4030	4275	5805	6570	Contact	Factory
36 x 60	Rectangle	HPL	CNCL 3660RE S	1	2	18"	1975	2145	2405	2530	Contact	Factory
36 x 60	Racetrack or Boat	HPL	CNCL 3660 ?T S	1	2	18"	2195	2225	2805	3090	Contact	Factory
36 x 72	Rectangle	HPL	CNCL 3672RE S	1	2	18"	2040	2245	2555	2705	Contact	Factory
36 x 72	Racetrack or Boat	HPL	CNCL 3672 ?T S	1	2	18"	2495	2325	2970	3290	Contact	Factory
36 x 84	Rectangle	HPL	CNCL 3684RE S	1	2	18"	2195	2340	2700	2875	Contact	Factory
36 x 84	Racetrack or Boat	HPL	CNCL 3684 ?T S	1	2	18"	2415	2530	3180	3500	Contact	Factory
36 x 96	Rectangle	HPL	CNCL 3696RE S	1	2	18"	2205	2435	2850	3055	Contact	Factory
36 x 96	Racetrack or Boat	HPL	CNCL 3696 ?T S	1	2	18"	2430	2545	3315	3700	Contact	Factory

BASE OPTIONS: [page 45 for base heights]

- Café Height – 36" High
- Bar Height – 42"
- Access Door

MODEL CODE LIST PRICE

- CH Contact Factory
- BH Contact Factory
- AD \$300 per base

TABLE OPTIONS:

- Custom Stain for wood edges
- Premium Laminate
- Premium Edge-banding

- UCS \$600 per color
- UCL Contact Factory
- UCE Contact Factory

POWER & A/V OPTIONS: [page 21- 38]

- Non-powered round ABS plastic Grommet (black or silver) | List location code on page 18
- Non-powered rectangle metal Grommet (black or silver) | List location code on page 18

- G (B/S) \$20 per grommet
- GV (B/S) \$120 per grommet

WIRE MANAGEMENT: [page 40 - 42]

- Customer specified hole cut into top
- 36" long Horizontal 4 track Extruded Raceway
- 12" wide x 34" wide Horizontal Conference Trough
- Wire Management access door

- CNC \$250 set up fee per template
- HW \$80 per piece
- WT \$475 list per Tray
- ADCN \$300 list price per door



Rectangle Top



Racetrack Top

How to Order:

- Email orders to: sales@hi5furniture.com
1. Choose your base model
 2. Add edge code to base model
 3. Choose finishes
 4. Select options to add to table
 5. Select finishes of options

Racetrack or Boat Shaped Tables:

Replace the ? with an RT (for Racetrack) or a BT (for Boat) to complete the model code. [ex. CNCL 3660 BT - for a 36x60 boat]

Laminate & FormaWrap Tables

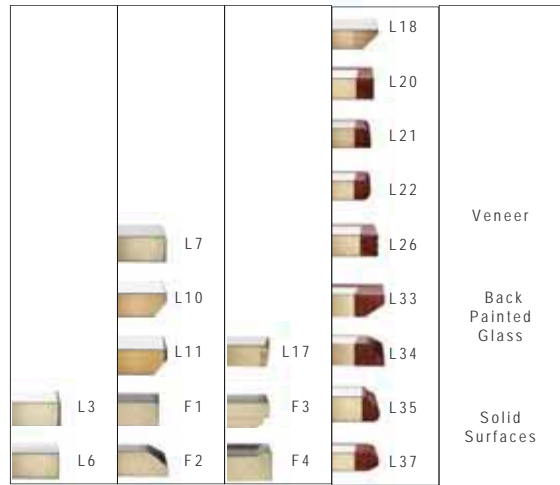

Table Size	Top Shape	Material	Model Code	Top QTY	Base QTY	Base Size	Price 1	Price 2	Price 3	Price 4	Notes
42 x 60	Rectangle	HPL	CNCL 4260RE S	1	2	18"	1990	2300	2985	3325	Contact Factory
42 x 60	Racetrack or Boat	HPL	CNCL 4260 ?T S	1	2	18"	2210	2385	3075	3415	Contact Factory
42 x 72	Rectangle	HPL	CNCL 4272RE S	1	2	18"	2055	2430	3205	3590	Contact Factory
42 x 72	Racetrack or Boat	HPL	CNCL 4272 ?T S	1	2	18"	2275	2510	3300	3690	Contact Factory
42 x 84	Rectangle	HPL	CNCL 4284RE S	1	2	18"	2210	3270	4225	4700	Contact Factory
42 x 84	Racetrack or Boat	HPL	CNCL 4284 ?T S	1	2	18"	2430	3350	4320	4800	Contact Factory
42 x 96	Rectangle	HPL	CNCL 4296RE S	1	2	18"	2220	3395	4445	4970	Contact Factory
42 x 96	Racetrack or Boat	HPL	CNCL 4296 ?T S	1	2	18"	2440	3480	4540	5065	Contact Factory
42 x 108	Rectangle	HPL	CNCL 42108RE S	1	2	18"	2350	3590	4765	5350	Contact Factory
42 x 108	Racetrack or Boat	HPL	CNCL 42108 ?T S	1	2	18"	2570	3680	4890	5490	Contact Factory
42 x 120	Rectangle	HPL	CNCL 42120RE S	1	2	18"	2365	3655	4895	5510	Contact Factory
42 x 120	Racetrack or Boat	HPL	CNCL 42120 ?T S	1	2	18"	2580	3730	4980	5600	Contact Factory
42 x 144	Rectangle	HPL	CNCL 42144RE S	2	3	18"	3575	4770	6300	7060	Contact Factory
42 x 144	Racetrack or Boat	HPL	CNCL 42144 ?T S	2	3	18"	3795	4855	6395	7160	Contact Factory
42 x 168	Rectangle	HPL	CNCL 42168RE S	2	3	18"	3695	5190	7065	8000	Contact Factory
42 x 168	Racetrack or Boat	HPL	CNCL 42168 ?T S	2	3	18"	3815	4880	7010	8070	Contact Factory
42 x 192	Rectangle	HPL	CNCL 42192RE S	2	3	18"	3615	5280	7185	8135	Contact Factory
42 x 192	Racetrack or Boat	HPL	CNCL 42192 ?T S	2	3	18"	3835	5360	7270	8225	Contact Factory
42 x 216	Rectangle	HPL	CNCL 42216RE S	2	3	18"	3640	6765	8305	9070	Contact Factory
42 x 216	Racetrack or Boat	HPL	CNCL 42216 ?T S	2	3	18"	3860	5710	7985	9120	Contact Factory
42 x 240	Rectangle	HPL	CNCL 42240RE S	2	4	18"	4415	6545	8915	10,095	Contact Factory
42 x 240	Racetrack or Boat	HPL	CNCL 42240 ?T S	2	4	18"	4635	6630	9010	10,195	Contact Factory

BASE OPTIONS: [page 45 for base heights]

- Café Height – 36" High
- Bar Height – 42"
- Access Door

MODEL CODE

- CH Contact Factory
- BH Contact Factory
- AD \$300 per base

TABLE OPTIONS:

- Custom Stain for wood edges
- Premium Laminate
- Premium Edge-banding

- UCS \$600 per color
- UCL Contact Factory
- UCE Contact Factory

POWER & A/V OPTIONS: [page 21- 38]

- Non-powered round ABS plastic Grommet (black or silver) | List location code on page 18
- Non-powered rectangle metal Grommet (black or silver) | List location code on page 18

- G (B/S) \$20 per grommet
- GV (B/S) \$120 per grommet

WIRE MANAGEMENT: [page 40 - 42]

- Customer specified hole cut into top
- 36" long Horizontal 4 track Extruded Raceway
- 12" wide x 34" wide Horizontal Conference Trough
- Wire Management access door

- CNC \$250 set up fee per template
- HW \$80 per piece
- WT \$475 list per Tray
- ADCN \$300 list price per door



Rectangle Top



Racetrack Top

How to Order:

Email orders to: sales@hi5furniture.com

1. Choose your base model
2. Add edge code to base model
3. Choose finishes
4. Select options to add to table
5. Select finishes of options

Racetrack or Boat Shaped Tables:

Replace the ? with an RT (for Racetrack) or a BT (for Boat) to complete the model code. [ex. CNCL 3660 BT - for a 36x60 boat]

Laminate Tables

															Veneer	Back Painted Glass	Solid Surfaces
--	--	--	--	--	--	--	--	--	--	--	--	--	--	--	--------	--------------------	----------------

Table Size	Top Shape	Material	Model Code	Top QTY	Base QTY	Base Size	L3	L6	L7	L10	L11	L17	L18	L20	L21	L22	L26	L33	L34	L35	L37	Notes
48 x 60	Rectangle	HPL	CNCL 4860RE S	1	2	18"	1990	2300	2985	3325												Contact Factory
48 x 60	Racetrack or Boat	HPL	CNCL 4860 ?T S	1	2	18"	2210	2385	3075	3415												Contact Factory
48 x 72	Rectangle	HPL	CNCL 4872RE S	1	2	18"	2055	2430	3205	3590												Contact Factory
48 x 72	Racetrack or Boat	HPL	CNCL 4872 ?T S	1	2	18"	2275	2510	3300	3690												Contact Factory
48 x 84	Rectangle	HPL	CNCL 4884RE S	1	2	18"	2210	3270	4225	4700												Contact Factory
48 x 84	Racetrack or Boat	HPL	CNCL 4884 ?T S	1	2	18"	2430	3350	4320	4800												Contact Factory
48 x 96	Rectangle	HPL	CNCL 4896RE S	1	2	18"	2220	3395	4445	4970												Contact Factory
48 x 96	Racetrack or Boat	HPL	CNCL 4896 ?T S	1	2	18"	2440	3480	4540	5065												Contact Factory
48 x 108	Rectangle	HPL	CNCL48108RE S	1	2	18"	2350	3590	4765	5350												Contact Factory
48 x 108	Racetrack or Boat	HPL	CNCL 48108 ?T S	1	2	18"	2570	3680	4890	5490												Contact Factory
48 x 120	Rectangle	HPL	CNCL 48120RE S	1	2	18"	2365	3655	4895	5510												Contact Factory
48 x 120	Racetrack or Boat	HPL	CNCL 48120 ?T S	1	2	18"	2580	3730	4980	5600												Contact Factory
48 x 144	Rectangle	HPL	CNCL 48144RE S	2	3	18"	3575	4770	6300	7060												Contact Factory
48 x 144	Racetrack or Boat	HPL	CNCL 48144 ?T S	2	3	18"	3795	4855	6395	7160												Contact Factory
48 x 168	Rectangle	HPL	CNCL48168RE S	2	3	18"	3695	5190	7065	8000												Contact Factory
48 x 168	Racetrack or Boat	HPL	CNCL 48168 ?T S	2	3	18"	3815	4880	7010	8070												Contact Factory
48 x 192	Rectangle	HPL	CNCL 48192RE S	2	3	18"	3615	5280	7185	8135												Contact Factory
48 x 192	Racetrack or Boat	HPL	CNCL 48192 ?T S	2	3	18"	3835	5360	7270	8225												Contact Factory
48 x 216	Rectangle	HPL	CNCL 48216RE S	2	3	18"	3640	6765	8305	9070												Contact Factory
48 x 216	Racetrack or Boat	HPL	CNCL 48216 ?T S	2	3	18"	3860	5710	7985	9120												Contact Factory
48 x 240	Rectangle	HPL	CNCL 48240RE S	2	4	18"	4415	6545	8915	10,095												Contact Factory
48 x 240	Racetrack or Boat	HPL	CNCL 48240 ?T S	2	4	18"	4635	6630	9008	10,195												Contact Factory

BASE OPTIONS: [page 45 for base heights]

- Café Height – 36" High
- Bar Height – 42"
- Access Door

MODEL CODE LIST PRICE

- CH Contact Factory
- BH Contact Factory
- AD \$300 per base

TABLE OPTIONS:

- Custom Stain for wood edges
- Premium Laminate
- Premium Edge-banding

- UCS \$600 per color
- UCL Contact Factory
- UCE Contact Factory

POWER & A/V OPTIONS: [page 21- 38]

- Non-powered round ABS plastic Grommet (black or silver) | List location code on page 18
- Non-powered rectangle metal Grommet (black or silver) | List location code on page 18

- G (B/S) \$20 per grommet
- GV (B/S) \$120 per grommet

WIRE MANAGEMENT: [page 40 - 42]

- Customer specified hole cut into top
- 36" long Horizontal 4 track Extruded Raceway
- 12" wide x 34" wide Horizontal Conference Trough
- Wire Management access door

- CNC \$250 set up fee per template
- HW \$80 per piece
- WT \$475 list per Tray
- ADCN \$300 list price per door



Rectangle Top



Racetrack Top

How to Order:

Email orders to: sales@hi5furniture.com

1. Choose your base model
2. Add edge code to base model
3. Choose finishes
4. Select options to add to table
5. Select finishes of options

Racetrack or Boat Shaped Tables:

Replace the ? with an RT (for Racetrack) or a BT (for Boat) to complete the model code.
[ex. CNCL 3660 BT - for a 36x60 boat]

Laminate Tables



Table Size	Top Shape	Material	Model Code:	Top QTY	Base QTY	Base Size	Price 1	Price 2	Price 3	Price 4	Category
60 x 72	Rectangle	HPL	CNCL 6072RE S	1	2	24"	2385	3675	4720	5240	Contact Factory
60 x 72	Racetrack or Boat	HPL	CNCL 6072 ?T S	1	2	24"	2605	3755	4805	5330	Contact Factory
60 x 84	Rectangle	HPL	CNCL 6084RE S	1	2	24"	2570	3725	4875	5445	Contact Factory
60 x 84	Racetrack or Boat	HPL	CNCL 6084 ?T S	1	2	24"	2790	3810	4965	5540	Contact Factory
60 x 96	Rectangle	HPL	CNCL 6096RE S	1	2	24"	2580	3885	5145	5775	Contact Factory
60 x 96	Racetrack or Boat	HPL	CNCL 6096 ?T S	1	2	24"	2800	3960	5230	5865	Contact Factory
60 x 108	Rectangle	HPL	CNCL 60108RE S	1	2	24"	2720	4165	5550	6240	Contact Factory
60 x 108	Racetrack or Boat	HPL	CNCL 60108 ?T S	1	2	24"	3940	4175	5645	6380	Contact Factory
60 x 120	Rectangle	HPL	CNCL 60120RE S	1	2	24"	2735	4200	5690	6435	Contact Factory
60 x 120	Racetrack or Boat	HPL	CNCL 60120 ?T S	1	2	24"	2855	4275	5780	6530	Contact Factory
60 x 144	Rectangle	HPL	CNCL 60144RE S	2	3	24"	4160	5495	7170	8255	Contact Factory
60 x 144	Racetrack or Boat	HPL	CNCL 60144 ?T S	2	3	24"	4380	5575	7430	8355	Contact Factory
60 x 168	Rectangle	HPL	CNCL 60168RE S	2	3	24"	4190	5935	8300	9480	Contact Factory
60 x 168	Racetrack or Boat	HPL	CNCL 60168 ?T S	2	3	24"	4410	6075	8350	9485	Contact Factory
60 x 192	Rectangle	HPL	CNCL 60192RE S	2	3	24"	4200	6120	8425	9575	Contact Factory
60 x 192	Racetrack or Boat	HPL	CNCL 60192 ?T S	2	3	24"	4420	6200	8520	9675	Contact Factory
60 x 216	Rectangle	HPL	CNCL 60216RE S	2	3	24"	4490	6690	9350	10,675	Contact Factory
60 x 216	Racetrack or Boat	HPL	CNCL 60216 ?T S	2	3	24"	4710	6720	9445	10,805	Contact Factory
60 x 240	Rectangle	HPL	CNCL 60240RE S	2	4	24"	5390	7625	10,500	11,935	Contact Factory
60 x 240	Racetrack or Boat	HPL	CNCL 60240 ?T S	2	4	24"	5610	7700	10,590	12,035	Contact Factory

BASE OPTIONS: [page 45 for base heights]

- Café Height – 36" High
- Bar Height – 42"
- Access Door

MODEL CODE

- CH Contact Factory
- BH Contact Factory
- AD \$300 per base

TABLE OPTIONS:

- Custom Stain for wood edges
- Premium Laminate
- Premium Edge-banding

- UCS \$600 per color
- UCL Contact Factory
- UCE Contact Factory

POWER & A/V OPTIONS: [page 21- 38]

- Non-powered round ABS plastic Grommet (black or silver) | List location code on page 18
- Non-powered rectangle metal Grommet (black or silver) | List location code on page 18
- G (B/S) \$20 per grommet
- GV (B/S) \$120 per grommet

WIRE MANAGEMENT: [page 40 - 42]

- Customer specified hole cut into top
- 36" long Horizontal 4 track Extruded Raceway
- 12" wide x 34" wide Horizontal Conference Trough
- Wire Management access door
- CNC \$250 set up fee per template
- HW \$80 per piece
- WT \$475 list per Tray
- ADCN \$300 list price per door

Capitol Options

Below are options that are available on all Capitol tables.



BASE OPTIONS: [page 45 for base heights]

- Café Height – 36" High
- Bar Height – 42"
- Alternate table height shorter than 29"
- Alternate table height taller than 29"

Locking Casters

TOP OPTIONS:

- Custom Stain for wood edges and veneers
- Premium Laminate
- Premium Edge-banding

POWER & AV OPTIONS : [page 21- 38]

- Non-powered round ABS plastic Grommet (black or silver) | List location code on page 18
- Non-powered rectangle metal Grommet (black or silver) | List location code on page 18

WIRE MANAGEMENT: [page 40 - 42]

- Customer specified hole cut into top
- Horizontal Wire management
- Vertical wire management (black or silver)
- Vertical wire management holes
- Wire Trough

ACCESSORIES: [pages 39 - 49 for options]

- Table Gangers (per set) (N/A on wood edge tops)
- Capitol Decorative Metal Base Inserts

NOTES:

- Capitol bases feature a hinged door for CPU storage and wire management. See page 45 for more information.



Decorative Metal Base Insert



Wire Management Access Door

MODEL CODE

LIST PRICE

CH	Contact Factory
BH	Contact Factory
SC	\$150 per table
TC – 24" & 30" tables	\$200 per table
TC - 36" tables	\$280 per table
CS	\$40 per base
UCS	\$600 per color
UCL	Contact Factory
UCE	Contact Factory
G (B/S)	\$20 per grommet
GV (B/S)	\$120 per grommet
CNC	\$250 set up fee per template
HW	\$80
VW B/S	\$25 per column
WH	\$30 per column
WT	\$475 per trough
TG	\$135 per set
DIP	\$200 per base

CONTACT FACTORY FOR LAYOUT, SIZE OPTIONS AND SPECIFICATION ASSISTANCE

Example Base Product Code :

CL CL 4860 RE S L3 - Options in
 Product Base Top Top Table Top - Options in
 Line style size shape function edge Alphabetical Order

Finish Selections:

BK 7909-60 BK
 Base Top Laminate or Edge
 Finish Veneer Selection Color



Shown with (DIP)
Decorative Panel

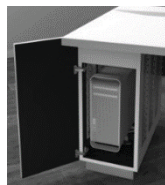

Capitol bases feature a hinged door for CPU storage and wire management.

How to Order:

Email orders to: sales@hi5furniture.com

1. Choose your base model
2. Add edge code to base model
3. Choose finishes
4. Select options to add to table
5. Select finishes of options

Racetrack or Boat Shaped Tables:

Replace the ? with an RT (for Racetrack) or a BT (for Boat) to complete the model code.
 [ex. CLCL 4860 BT - for a 48x60 boat]

Laminate Tables

				L18	
				L20	
				L21	
				L22	Veneer
				L26	
				L33	Back Painted Glass
				L34	
				L35	
				L37	Solid Surfaces
L3					
	L7				
		L10			
			L11		
				L17	

Table Size	Top Shape	Base Material	Model Code:	Top QTY	Base QTY	Base Size						
48 x 60	Rectangle	HPL	CLCL 4860RE S	1	2	12" x 24"	3340	3655	4505	4925	Contact	Factory
48 x 60	Racetrack or Boat	HPL	CLCL 4860 ?T S	1	2	12" x 24"	3560	3735	4585	5015	Contact	Factory
48 x 72	Rectangle	HPL	CLCL 4872RE S	1	2	12" x 24"	3405	3780	4720	5190	Contact	Factory
48 x 72	Racetrack or Boat	HPL	CLCL 4872 ?T S	1	2	12" x 24"	3625	3865	4275	4475	Contact	Factory
48 x 84	Rectangle	HPL	CLCL 4884RE S	1	2	12" x 24"	3560	4620	5740	6300	Contact	Factory
48 x 84	Racetrack or Boat	HPL	CLCL 4884 ?T S	1	2	12" x 24"	3780	4705	5835	6400	Contact	Factory
48 x 96	Rectangle	HPL	CLCL 4896RE S	1	2	12" x 24"	3570	4750	5960	6565	Contact	Factory
48 x 96	Racetrack or Boat	HPL	CLCL 4896 ?T S	1	2	12" x 24"	3790	4830	6055	6665	Contact	Factory
48 x 108	Rectangle	HPL	CLCL 48108RE S	1	2	12" x 24"	3705	4940	6280	6950	Contact	Factory
48 x 108	Racetrack or Boat	HPL	CLCL 48108 ?T S	1	2	12" x 24"	3925	5035	6405	7085	Contact	Factory
48 x 120	Rectangle	HPL	CLCL 48120RE S	1	2	12" x 24"	3715	5005	6405	7105	Contact	Factory
48 x 120	Racetrack or Boat	HPL	CLCL 48120 ?T S	1	2	12" x 24"	3935	5085	6495	7200	Contact	Factory
48 x 144	Rectangle	HPL	CLCL 48144RE S	2	3	12" x 24"	5605	6800	8575	9460	Contact	Factory
48 x 144	Racetrack or Boat	HPL	CLCL 48144 ?T S	2	3	12" x 24"	5825	6885	8665	9555	Contact	Factory
48 x 168	Rectangle	HPL	CLCL 48168RE S	2	3	12" x 24"	5625	7220	9340	10,395	Contact	Factory
48 x 168	Racetrack or Boat	HPL	CLCL 48168 ?T S	2	3	12" x 24"	5845	7290	9410	10,465	Contact	Factory
48 x 192	Rectangle	HPL	CLCL 48192RE S	2	3	12" x 24"	5645	7310	9460	10,530	Contact	Factory
48 x 192	Racetrack or Boat	HPL	CLCL 48192 ?T S	2	3	12" x 24"	5865	7390	9550	10,625	Contact	Factory
48 x 216	Rectangle	HPL	CLCL 48216RE S	2	3	12" x 24"	5670	7710	10,220	11,470	Contact	Factory
48 x 216	Racetrack or Boat	HPL	CLCL 48216 ?T S	2	3	12" x 24"	5885	7740	10,260	11,520	Contact	Factory
48 x 240	Rectangle	HPL	CLCL 48240RE S	2	4	12" x 24"	7120	9255	11,950	13,295	Contact	Factory
48 x 240	Racetrack or Boat	HPL	CLCL 48240 ?T S	2	4	12" x 24"	7340	9335	12,040	13,390	Contact	Factory

BASE OPTIONS: [page 45 for base heights]

- Café Height – 36" High
- Bar Height – 42"

Locking Casters

TOP OPTIONS:

- Custom Slain for wood edges and veneers
- Premium Laminate
- Premium Edge-banding

POWER & A/V OPTIONS : [page 21- 38]

- Non-powered round ABS plastic Grommet (black or silver) | List location code on page 18
- Non-powered rectangle metal Grommet (black or silver) | List location code on page 18

WIRE MANAGEMENT: [page 40 - 42]

- Customer specified hole cut into top
- Horizontal Wire management
- Wire Trough

ACCESSORIES: [pages 39 - 49 for options]

- Capitol Decorative Metal Base Inserts

MODEL CODE

- CH
- BH
- TC - 36" tables
- CS

LIST PRICE

- Contact Factory
- Contact Factory
- \$280 per table
- \$40 per base

UCS

\$600 per color

UCL

Contact Factory

UCE

Contact Factory

G (B/S)

\$20 per grommet

GV (B/S)

\$120 per grommet

CNC

\$250 set up fee per template

HW

\$80

WT

\$475 per trough

DIP

\$200 per base



Shown with (DIP) Decorative Panel



Capitol bases feature a hinged door for CPU storage and wire management.

How to Order:

- Email orders to: sales@hi5furniture.com
- 1. Choose your base model
- 2. Add edge code to base model
- 3. Choose finishes
- 4. Select options to add to table
- 5. Select finishes of options

Racetrack or Boat Shaped Tables:

Replace the ? with an RT (for Racetrack) or a BT (for Boat) to complete the model code. [ex. CLCL 6072 BT - for a 60x72 boat]

Laminate Tables

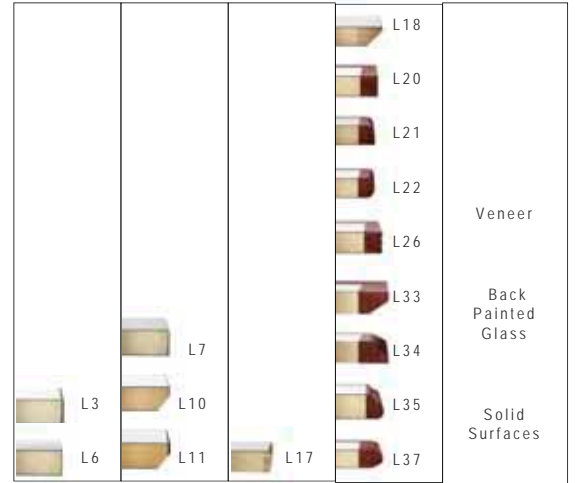

Table Size	Top Shape	Base Material	Model Code:	Top QTY	Base QTY	Base Size	3835	5130	6350	6955	Contact Factory
60 x 72	Rectangle	HPL	CLCL 6072RE S	1	2	12" x 30"	3835	5130	6350	6955	Contact Factory
60 x 72	Racetrack or Boat	HPL	CLCL 6072 ?T S	1	2	12" x 30"	4055	5205	6440	7050	Contact Factory
60 x 84	Rectangle	HPL	CLCL 6084RE S	1	2	12" x 30"	4025	5180	6500	7160	Contact Factory
60 x 84	Racetrack or Boat	HPL	CLCL 6084 ?T S	1	2	12" x 30"	4245	4500	6505	7255	Contact Factory
60 x 96	Rectangle	HPL	CLCL 6096RE S	1	2	12" x 30"	4035	5335	6840	7590	Contact Factory
60 x 96	Racetrack or Boat	HPL	CLCL 6096 ?T S	1	2	12" x 30"	4255	5415	6860	7580	Contact Factory
60 x 108	Rectangle	HPL	CLCL 60108RE S	1	2	12" x 30"	4170	5620	7180	7960	Contact Factory
60 x 108	Racetrack or Boat	HPL	CLCL 60108 ?T S	1	2	12" x 30"	4390	5630	7275	8095	Contact Factory
60 x 120	Rectangle	HPL	CLCL 60120RE S	1	2	12" x 30"	4190	5650	7320	8155	Contact Factory
60 x 120	Racetrack or Boat	HPL	CLCL 60120 ?T S	1	2	12" x 30"	4410	5730	7410	8245	Contact Factory
60 x 144	Rectangle	HPL	CLCL 60144RE S	2	3	12" x 30"	9670	11,010	13,520	14,770	Contact Factory
60 x 144	Racetrack or Boat	HPL	CLCL 60144 ?T S	2	3	12" x 30"	9890	11,085	13,609	14,870	Contact Factory
60 x 168	Rectangle	HPL	CLCL 60168RE S	2	3	12" x 30"	9700	11,450	14,480	15,990	Contact Factory
60 x 168	Racetrack or Boat	HPL	CLCL 60168 ?T S	2	3	12" x 30"	9920	11,585	14,530	16,000	Contact Factory
60 x 192	Rectangle	HPL	CLCL 60192RE S	2	3	12" x 30"	9710	11,630	14,605	16,090	Contact Factory
60 x 192	Racetrack or Boat	HPL	CLCL 60192 ?T S	2	3	12" x 30"	9930	11,710	14,695	16,185	Contact Factory
60 x 216	Rectangle	HPL	CLCL 60216RE S	2	3	12" x 30"	13,320	15,520	19,250	21,110	Contact Factory
60 x 216	Racetrack or Boat	HPL	CLCL 60216 ?T S	2	3	12" x 30"	13,540	15,545	19,345	21,240	Contact Factory
60 x 240	Rectangle	HPL	CLCL 60240RE S	2	4	12" x 30"	17,160	19,395	23,695	25,845	Contact Factory
60 x 240	Racetrack or Boat	HPL	CLCL 60240 ?T S	2	4	12" x 30"	17,380	19,470	23,790	25,945	Contact Factory

BASE OPTIONS: [page 45 for base heights]

- Café Height – 36" High
- Bar Height – 42"

Locking Casters

TOP OPTIONS:

- Custom Slain for wood edges and veneers
- Premium Laminate
- Premium Edge-banding

POWER & A/V OPTIONS : [page 21- 38]

- Non-powered round ABS plastic Grommet (black or silver) | List location code on page 18
- Non-powered rectangle metal Grommet (black or silver) | List location code on page 18

WIRE MANAGEMENT: [page 40 - 42]

- Customer specified hole cut into top
- Horizontal Wire management
- Wire Trough

ACCESSORIES: [pages 39 - 49 for options]

- Capitol Decorative Metal Base Inserts

MODEL CODE

- CH
- BH
- TC - 36" tables
- CS

LIST PRICE

- Contact Factory
- Contact Factory
- \$280 per table
- \$40 per base

- UCS
- UCL
- UCE

- \$600 per color
- Contact Factory
- Contact Factory

- G (B/S)
- GV (B/S)

- \$20 per grommet
- \$120 per grommet

- CNC
- HW
- WT

- \$250 set up fee per template
- \$80
- \$475 per trough

- DIP

- \$200 per base

Coby Apron Options

Below are options that are available on all Coby tables.



BASE OPTIONS: [page 45 for base heights]

Alternate table height shorter than 29" (stationary tables only)

Alternate table height taller than 29" (stationary tables only)

Locking Casters (ADDS 2" TO HEIGHT OF TABLE)

Add Foot Rail to shorter than 84" long tables

Self-Adjustable Glides

TABLE OPTIONS:

Custom Stain for wood edges and veneers

Premium Laminate

Premium Edge-banding

POWER & A/V OPTIONS : [page 21- 38]

Non-powered round ABS plastic Grommet (black or silver) | List location code on page 18

Non-powered rectangle metal Grommet (black or silver) | List location code on page 18

WIRE MANAGEMENT: [page 40 - 42]

Customer specified hole cut into top

Vertical ABS Leg Way for table base (black or silver)

36" long Horizontal 4 track Extruded Raceway

NOTES:

- Coby Apron Base tables feature formed steel clutch hooks. These hooks are placed strategically around the table. For more information see page 46.
- Tables 84" Long, and longer, come standard with a Footrail.

MODEL CODE

LIST PRICE

SC	\$750 per table (Add 2week lead time)
TC – 24" & 30" deep tables	\$750 per table (Add 2week lead time)
TC - 36" deep tables	\$750 per table (Add 2week lead time)
CS	\$80 list per table
FT	\$550 list per table
SAGS	\$100 per base
UCS	\$600 per color
UCL	contact factory
UCE	contact factory
G (B/S)	\$20 per grommet
GV (B/S)	\$120 per grommet
CNC	\$250 set up fee per template
WR (B/S)	\$25 list per piece
HW	\$80 per piece



Shown with Footrail



Shown without Footrail



Clutch Hooks

CONTACT FACTORY FOR LAYOUT, SIZE OPTIONS AND SPECIFICATION ASSISTANCE

Example Base Product Code :

CY AP 3060 RE S L3 - Options in
Product Base Top Top Table Top -
Line style size shape function edge Alphabetical Order

Finish Selections:

BK 7909-60 BK
Base Top Laminate or Edge
Finish Veneer Selection Color



How to Order:
 Email orders to: sales@hi5furniture.com
 1. Choose your base model
 2. Add edge code to base model
 3. Choose finishes
 4. Select options to add to table
 5. Select finishes of options

Laminate & FormaWrap Tables

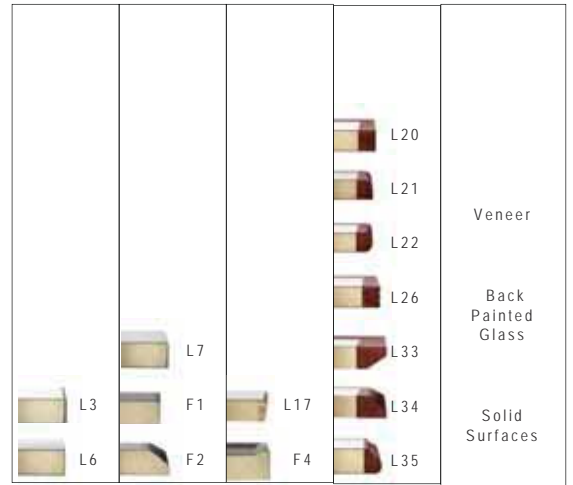

Table Size	Model Code:	Top QTY	Post Base QTY						
18 x 18 X 18" h	CYAP 18SQ -18H	1	4	1675	1725	1735	1785	Contact Factory	
18 x 18 X 29" h	CYAP 18SQ -29H	1	4	1810	1860	1870	1920	Contact Factory	
18 x 18 X 36" h	CYAP 18SQ -36H	1	4	1945	1995	2005	2055	Contact Factory	
18 x 18 X 42" h	CYAP 18SQ -42H	1	4	2080	2130	2140	2190	Contact Factory	
24 x 24 X 18" h	CYAP 24SQ -18H	1	4	1760	1810	1820	1870	Contact Factory	
24 x 24 X 29" h	CYAP 24SQ -29H	1	4	1895	1945	1955	2005	Contact Factory	
24 x 24 X 36" h	CYAP 24SQ -36H	1	4	2030	2080	2090	2140	Contact Factory	
24 x 24 X 42" h	CYAP 24SQ -42H	1	4	2165	2215	2225	2275	Contact Factory	
30 x 30 X 18" h	CYAP 30SQ -18H	1	4	1910	1965	2090	2180	Contact Factory	
30 x 30 X 29" h	CYAP 30SQ -29H	1	4	2045	2100	2225	2315	Contact Factory	
30 x 30 X 36" h	CYAP 30SQ -36H	1	4	2180	2235	2360	2450	Contact Factory	
30 x 30 X 42" h	CYAP 30SQ -42H	1	4	2315	2370	2495	2585	Contact Factory	
36 x 36 X 18" h	CYAP 36SQ -18H	1	4	2060	2120	2280	2545	Contact Factory	
36 x 36 X 29" h	CYAP 36SQ -29H	1	4	2195	2255	2415	2680	Contact Factory	
36 x 36 X 36" h	CYAP 36SQ -36H	1	4	2330	2390	2550	2815	Contact Factory	
36 x 36 X 42" h	CYAP 36SQ -42H	1	4	2465	2525	2685	2950	Contact Factory	
42 x 42 X 18" h	CYAP 42SQ -18H	1	4	2165	2235	2615	3060	Contact Factory	
42 x 42 X 29" h	CYAP 42SQ -29H	1	4	2300	2370	2750	3195	Contact Factory	
42 x 42 X 36" h	CYAP 42SQ -36H	1	4	2435	2505	2885	3330	Contact Factory	
42 x 42 X 42" h	CYAP 42SQ -42H	1	4	2570	2640	3020	3465	Contact Factory	
48 x 48 X 18" h	CYAP 48SQ -18H	1	4	2265	2340	2945	3410	Contact Factory	
48 x 48 X 29" h	CYAP 48SQ -29H	1	4	2400	2475	3080	3545	Contact Factory	
48 x 48 X 36" h	CYAP 48SQ -36H	1	4	2535	2610	3215	3680	Contact Factory	
48 x 48 X 42" h	CYAP 48SQ -42H	1	4	2670	2745	3350	3815	Contact Factory	
60 x 60 X 18" h	CYAP 60SQ -18H	1	4	2545	2645	3710	4435	Contact Factory	
60 x 60 X 29" h	CYAP 60SQ -29H	1	4	2680	2780	3845	4570	Contact Factory	
60 x 60 X 36" h	CYAP 60SQ -36H	1	4	2815	2915	3980	4710	Contact Factory	
60 x 60 X 42" h	CYAP 60SQ -42H	1	4	2950	3050	4115	4840	Contact Factory	

BASE OPTIONS: [page 45 for base heights]

Alternate table height shorter than 29" (stationary tables only)
 Alternate table height taller than 29" (stationary tables only)

Locking Casters (ADDS 2" TO HEIGHT OF TABLE)
 Add Foot Rail to shorter than 84" long tables
 Self-Adjustable Glides

TABLE OPTIONS:

Custom Stain for wood edges and veneers
 Premium Laminate
 Premium Edge-banding

POWER & AVV OPTIONS : [page 21-38]

Non-powered round ABS plastic Grommet (black or silver) | List location code on page 18
 Non-powered rectangle metal Grommet (black or silver) | List location code on page 18

WIRE MANAGEMENT: [page 40 - 42]

Customer specified hole cut into top
 Vertical ABS Leg Way for table base (black or silver)
 36" long Horizontal 4 track Extruded Raceway

MODEL CODE

SC
 TC - 24" & 30" deep tables
 TC - 36" deep tables
 CS
 FT
 SAGS

UCS
 UCL
 UCE

G (B/S)
 GV (B/S)

CNC
 WR (B/S)
 HW

LIST PRICE

\$750 per table (Add 2week lead time)
 \$750 per table (Add 2week lead time)
 \$750 per table (Add 2week lead time)
 \$80 list per table
 \$550 list per table
 \$100 per base

\$600 per color
 Contact Factory
 Contact Factory

\$20 per grommet
 \$120 per grommet

\$250 set up fee per template
 \$25 list per piece
 \$80 per piece



Shown with Footrail



Shown without Footrail

How to Order:

Email orders to: sales@hi5furniture.com

1. Choose your base model
2. Add edge code to base model
3. Choose finishes
4. Select options to add to table
5. Select finishes of options

FormaWrap (F1, F2, F3, F4 edges) are only available up to 36" x 84" sized tables.

Laminate & FormaWrap Tables

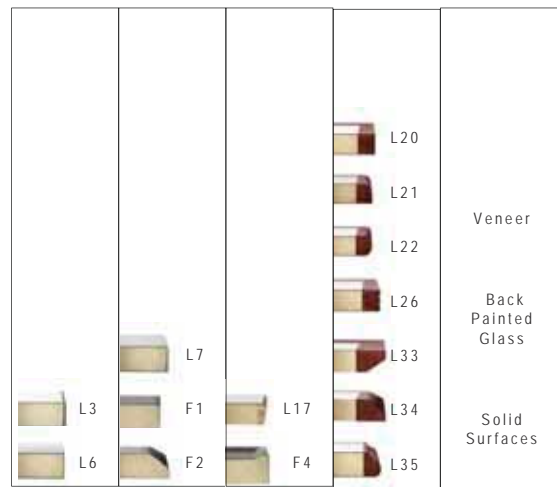

Table Size	Model Code:	Post			1805	1855	1930	2110	Contact Factory
		Top QTY	Base QTY	Foot Rail					
18 x 36 X 18" h	CYAP 183618RE S	1	4	No	1805	1855	1930	2110	Contact Factory
18 x 36 X 29" h	CYAP 183629RE S	1	4	No	1940	1990	2065	2245	Contact Factory
18 x 36 X 36" h	CYAP 183636RE S	1	4	No	2075	2125	2200	2380	Contact Factory
18 x 36 X 42" h	CYAP 183642RE S	1	4	No	2210	2260	2335	2515	Contact Factory
18 x 42 X 18" h	CYAP 184218RE S	1	4	No	1860	1920	2115	2355	Contact Factory
18 x 42 X 29" h	CYAP 184229RE S	1	4	No	1995	2055	2250	2490	Contact Factory
18 x 42 X 36" h	CYAP 184236RE S	1	4	No	2130	2190	2385	2625	Contact Factory
18 x 42 X 42" h	CYAP 184242RE S	1	4	No	2265	2325	2520	2760	Contact Factory
18 x 48 X 18" h	CYAP 184818RE S	1	4	No	1905	1965	2160	2400	Contact Factory
18 x 48 X 29" h	CYAP 184829RE S	1	4	No	2040	2100	2295	2535	Contact Factory
18 x 48 X 36" h	CYAP 184836RE S	1	4	No	2175	2235	2430	2670	Contact Factory
18 x 48 X 42" h	CYAP 183482RE S	1	4	No	2310	2370	2565	2805	Contact Factory
18 x 60 X 18" h	CYAP 186018RE S	1	4	No	2020	2085	2350	2640	Contact Factory
18 x 60 X 29" h	CYAP 186029RE S	1	4	No	2155	2220	2485	2775	Contact Factory
18 x 60 X 36" h	CYAP 186036RE S	1	4	No	2290	2355	2620	2910	Contact Factory
18 x 60 X 42" h	CYAP 186042RE S	1	4	No	2425	2490	2755	3045	Contact Factory
18 x 72 X 18" h	CYAP 187218RE S	1	4	No	2125	2205	2540	2895	Contact Factory
18 x 72 X 29" h	CYAP 187229RE S	1	4	No	2260	2340	2675	3030	Contact Factory
18 x 72 X 36" h	CYAP 187236RE S	1	4	No	2395	2475	2810	3165	Contact Factory
18 x 72 X 42" h	CYAP 183722RE S	1	4	No	2530	2610	2945	3300	Contact Factory
18 x 84 X 18" h	CYAP 188418RE S	1	4	Yes	2745	2825	3410	3865	Contact Factory
18 x 84 X 29" h	CYAP 188429RE S	1	4	Yes	2880	2960	3545	4000	Contact Factory
18 x 84 X 36" h	CYAP 188436RE S	1	4	Yes	3015	3095	3680	4135	Contact Factory
18 x 84 X 42" h	CYAP 188442RE S	1	4	Yes	3150	3230	3815	4270	Contact Factory
18 x 96 X 18" h	CYAP 189618RE S	1	4	Yes	2795	2890	3465	3920	Contact Factory
18 x 96 X 29" h	CYAP 189629RE S	1	4	Yes	2930	3025	3600	4055	Contact Factory
18 x 96 X 36" h	CYAP 189636RE S	1	4	Yes	3065	3160	3735	4190	Contact Factory
18 x 96 X 42" h	CYAP 189642RE S	1	4	Yes	3200	3295	3870	4325	Contact Factory

BASE OPTIONS: [page 45 for base heights]

- Alternate table height shorter than 29" (stationary tables only)
- Alternate table height taller than 29" (stationary tables only)

Locking Casters (ADDS 2" TO HEIGHT OF TABLE)

Add Foot Rail to shorter than 84" long tables

Self-Adjustable Glides

TABLE OPTIONS:

- Custom Stain for wood edges and veneers
- Premium Laminate
- Premium Edge-banding

POWER & AVV OPTIONS: [page 21-38]

- Non-powered round ABS plastic Grommet (black or silver) | List location code on page 18
- Non-powered rectangle metal Grommet (black or silver) | List location code on page 18

WIRE MANAGEMENT: [page 40 - 42]

- Customer specified hole cut into top
- Vertical ABS Leg Way for table base (black or silver)
- 36" long Horizontal 4 track Extruded Raceway

MODEL CODE

- SC
- TC - 24" & 30" deep tables
- TC - 36" deep tables
- CS
- FT
- SAGS

LIST PRICE

- \$750 per table (Add 2week lead time)
- \$750 per table (Add 2week lead time)
- \$750 per table (Add 2week lead time)
- \$80 list per table
- \$550 list per table
- \$100 per base

- UCS
- UCL
- UCE

- \$600 per color
- Contact Factory
- Contact Factory

- G (B/S)
- GV (B/S)

- \$20 per grommet
- \$120 per grommet

- CNC
- WR (B/S)
- HW

- \$250 set up fee per template
- \$25 list per piece
- \$80 per piece



Shown with Footrail



Shown without Footrail

How to Order:

Email orders to: sales@hi5furniture.com

1. Choose your base model
2. Add edge code to base model
3. Choose finishes
4. Select options to add to table
5. Select finishes of options

FormaWrap (F1, F2, F3, F4 edges) are only available up to 36" x 84" sized tables.

Laminate & FormaWrap Tables

Table Size	Model Code:	Post			1870	1920	1995	2155	Contact Factory
		Top QTY	Base QTY	Foot Rail					
24 x 36 X 18" h	CYAP 243618RE S	1	4	No	1870	1920	1995	2155	Contact Factory
24 x 36 X 29" h	CYAP 243629RE S	1	4	No	2005	2055	2130	2290	Contact Factory
24 x 36 X 36" h	CYAP 243636RE S	1	4	No	2140	2190	2265	2425	Contact Factory
24 x 36 X 42" h	CYAP 243642RE S	1	4	No	2275	2325	2400	2560	Contact Factory
24 x 42 X 18" h	CYAP 244218RE S	1	4	No	1920	1975	2140	2330	Contact Factory
24 x 42 X 29" h	CYAP 244229RE S	1	4	No	2055	2110	2275	2465	Contact Factory
24 x 42 X 36" h	CYAP 244236RE S	1	4	No	2190	2245	2410	2600	Contact Factory
24 x 42 X 42" h	CYAP 244242RE S	1	4	No	2325	2380	2545	2735	Contact Factory
24 x 48 X 18" h	CYAP 244818RE S	1	4	No	1970	2030	2225	2445	Contact Factory
24 x 48 X 29" h	CYAP 244829RE S	1	4	No	2105	2165	2360	2580	Contact Factory
24 x 48 X 36" h	CYAP 244836RE S	1	4	No	2240	2300	2495	2715	Contact Factory
24 x 48 X 42" h	CYAP 244842RE S	1	4	No	2375	2435	2630	2850	Contact Factory
24 x 60 X 18" h	CYAP 246018RE S	1	4	No	2085	2150	2415	2685	Contact Factory
24 x 60 X 29" h	CYAP 246029RE S	1	4	No	2220	2285	2550	2820	Contact Factory
24 x 60 X 36" h	CYAP 246036RE S	1	4	No	2355	2420	2685	2955	Contact Factory
24 x 60 X 42" h	CYAP 246042RE S	1	4	No	2490	2555	2820	3090	Contact Factory
24 x 72 X 18" h	CYAP 247218RE S	1	4	No	2190	2270	2605	2940	Contact Factory
24 x 72 X 29" h	CYAP 247229RE S	1	4	No	2325	2405	2740	3075	Contact Factory
24 x 72 X 36" h	CYAP 247236RE S	1	4	No	2460	2540	2875	3210	Contact Factory
24 x 72 X 42" h	CYAP 247242RE S	1	4	No	2595	2675	3010	3345	Contact Factory
24 x 84 X 18" h	CYAP 248418RE S	1	4	Yes	2810	2890	3475	3910	Contact Factory
24 x 84 X 29" h	CYAP 248429RE S	1	4	Yes	2945	3025	3610	4045	Contact Factory
24 x 84 X 36" h	CYAP 248436RE S	1	4	Yes	3080	3160	3745	4180	Contact Factory
24 x 84 X 42" h	CYAP 248442RE S	1	4	Yes	3215	3295	3880	4315	Contact Factory
24 x 96 X 18" h	CYAP 249618RE S	1	4	Yes	2860	2955	3530	3965	Contact Factory
24 x 96 X 29" h	CYAP 249629RE S	1	4	Yes	2995	3090	3665	4100	Contact Factory
24 x 96 X 36" h	CYAP 249636RE S	1	4	Yes	3130	3225	3800	4235	Contact Factory
24 x 96 X 42" h	CYAP 249642RE S	1	4	Yes	3265	3360	3935	4370	Contact Factory

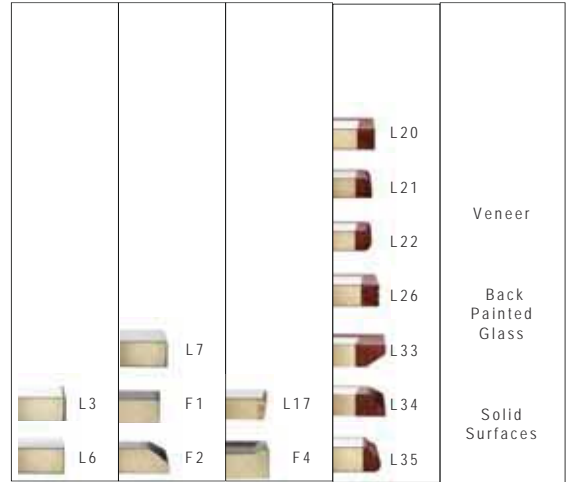

BASE OPTIONS: [page 45 for base heights]

- Alternate table height shorter than 29" (stationary tables only)
- Alternate table height taller than 29" (stationary tables only)

- Locking Casters (ADDS 2" TO HEIGHT OF TABLE)
- Add Foot Rail to shorter than 84" long tables
- Self-Adjustable Glides

TABLE OPTIONS:

- Custom Stain for wood edges and veneers
- Premium Laminate
- Premium Edge-banding

POWER & A/V OPTIONS: [page 21-38]

- Non-powered round ABS plastic Grommet (black or silver) | List location code on page 18
- Non-powered rectangle metal Grommet (black or silver) | List location code on page 18

WIRE MANAGEMENT: [page 40 - 42]

- Customer specified hole cut into top
- Vertical ABS Leg Way for table base (black or silver)
- 36" long Horizontal 4 track Extruded Raceway

MODEL CODE

- SC
- TC - 24" & 30" deep tables
- TC - 36" deep tables
- CS
- FT
- SAGS

- UCS
- UCL
- UCE

- G (B/S)
- GV (B/S)

- CNC
- WR (B/S)
- HW

LIST PRICE

- \$750 per table (Add 2week lead time)
- \$750 per table (Add 2week lead time)
- \$750 per table (Add 2week lead time)
- \$80 list per table
- \$550 list per table
- \$100 per base

- \$600 per color
- Contact Factory
- Contact Factory

- \$20 per grommet
- \$120 per grommet

- \$250 set up fee per template
- \$25 list per piece
- \$80 per piece



Shown with Footrail



Shown without Footrail

How to Order:

Email orders to: sales@hi5furniture.com

1. Choose your base model
2. Add edge code to base model
3. Choose finishes
4. Select options to add to table
5. Select finishes of options

FormaWrap (F1, F2, F3, F4 edges) are only available up to 36" x 84" sized tables.

Laminate & FormaWrap Tables

				Veneer
				Back Painted Glass
				Solid Surfaces

Table Size	Model Code:	Top QTY	Post Base QTY	Foot Rail					
30 x 36 X 18" h	CYAP 303618RE S	1	4	No	1920	1975	2130	2350	Contact Factory
30 x 36 X 29" h	CYAP 303629RE S	1	4	No	2055	2110	2265	2485	Contact Factory
30 x 36 X 36" h	CYAP 303636RE S	1	4	No	2190	2245	2400	2620	Contact Factory
30 x 36 X 42" h	CYAP 303642RE S	1	4	No	2325	2380	2535	2755	Contact Factory
30 x 42 X 18" h	CYAP 304218RE S	1	4	No	2030	2095	2350	2640	Contact Factory
30 x 42 X 29" h	CYAP 304229RE S	1	4	No	2165	2230	2485	2775	Contact Factory
30 x 42 X 36" h	CYAP 304236RE S	1	4	No	2300	2365	2620	2910	Contact Factory
30 x 42 X 42" h	CYAP 304242RE S	1	4	No	2435	2500	2755	3045	Contact Factory
30 x 48 X 18" h	CYAP 304818RE S	1	4	No	2075	2140	2395	2685	Contact Factory
30 x 48 X 29" h	CYAP 304829RE S	1	4	No	2210	2275	2530	2820	Contact Factory
30 x 48 X 36" h	CYAP 304836RE S	1	4	No	2345	2410	2665	2955	Contact Factory
30 x 48 X 42" h	CYAP 304842RE S	1	4	No	2480	2545	2800	3090	Contact Factory
30 x 60 X 18" h	CYAP 306018RE S	1	4	No	2200	2275	2615	2980	Contact Factory
30 x 60 X 29" h	CYAP 306029RE S	1	4	No	2335	2410	2750	3115	Contact Factory
30 x 60 X 36" h	CYAP 306036RE S	1	4	No	2470	2545	2885	3250	Contact Factory
30 x 60 X 42" h	CYAP 306042RE S	1	4	No	2605	2680	3020	3385	Contact Factory
30 x 72 X 18" h	CYAP 307218RE S	1	4	No	2320	2405	2830	3280	Contact Factory
30 x 72 X 29" h	CYAP 307229RE S	1	4	No	2455	2540	2965	3415	Contact Factory
30 x 72 X 36" h	CYAP 307236RE S	1	4	No	2590	2675	3100	3550	Contact Factory
30 x 72 X 42" h	CYAP 307242RE S	1	4	No	2725	2810	3235	3685	Contact Factory
30 x 84 X 18" h	CYAP 308418RE S	1	4	Yes	2935	3025	3765	4350	Contact Factory
30 x 84 X 29" h	CYAP 308429RE S	1	4	Yes	3070	3160	3900	4485	Contact Factory
30 x 84 X 36" h	CYAP 308436RE S	1	4	Yes	3205	3295	4035	4620	Contact Factory
30 x 84 X 42" h	CYAP 308442RE S	1	4	Yes	3340	3430	4170	4755	Contact Factory
30 x 96 X 18" h	CYAP 309618RE S	1	4	Yes	2990	3090	3815	4415	Contact Factory
30 x 96 X 29" h	CYAP 309629RE S	1	4	Yes	3125	3225	3950	4550	Contact Factory
30 x 96 X 36" h	CYAP 309636RE S	1	4	Yes	3260	3360	4085	4685	Contact Factory
30 x 96 X 42" h	CYAP 309642RE S	1	4	Yes	3395	3495	4220	4820	Contact Factory

BASE OPTIONS: [page 45 for base heights]

- Alternate table height shorter than 29" (stationary tables only)
- Alternate table height taller than 29" (stationary tables only)

Locking Casters (ADDS 2" TO HEIGHT OF TABLE)

Add Foot Rail to shorter than 84" long tables

Self-Adjustable Glides

TABLE OPTIONS:

- Custom Stain for wood edges and veneers
- Premium Laminate
- Premium Edge-banding

POWER & AVV OPTIONS: [page 21-38]

- Non-powered round ABS plastic Grommet (black or silver) | List location code on page 18
- Non-powered rectangle metal Grommet (black or silver) | List location code on page 18

WIRE MANAGEMENT: [page 40 - 42]

- Customer specified hole cut into top
- Vertical ABS Leg Way for table base (black or silver)
- 36" long Horizontal 4 track Extruded Raceway

MODEL CODE

- SC \$750 per table (Add 2week lead time)
- TC - 24" & 30" deep tables \$750 per table (Add 2week lead time)
- TC - 36" deep tables \$750 per table (Add 2week lead time)
- CS \$80 list per table
- FT \$550 list per table
- SAGS \$100 per base

LIST PRICE

- UCS \$600 per color
- UCL Contact Factory
- UCE Contact Factory

- G (B/S) \$20 per grommet
- GV (B/S) \$120 per grommet

- CNC \$250 set up fee per template
- WR (B/S) \$25 list per piece
- HW \$80 per piece



How to Order:
 Email orders to: sales@hi5furniture.com
 1. Choose your base model
 2. Add edge code to base model
 3. Choose finishes
 4. Select options to add to table
 5. Select finishes of options

FormaWrap (F1, F2, F3, F4 edges) are only available up to 36" x 84" sized tables.



Shown with Footrail



Shown without Footrail

Laminate & FormaWrap Tables

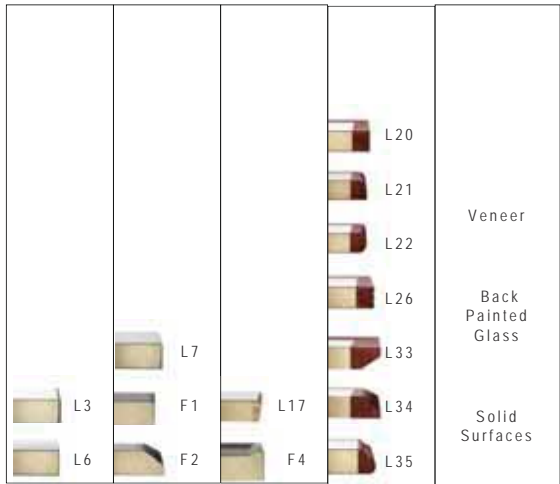

Table Size	Model Code:	Post			Top QTY	Base QTY	Foot Rail						
		Top	Base	Foot									
36 x 48 X 18" h	CYAP 364818RE S	1	4	No	1	4	No	2195	2265	2580	2930	Contact Factory	
36 x 48 X 29" h	CYAP 364829RE S	1	4	No	1	4	No	2330	2400	2715	3065	Contact Factory	
36 x 48 X 36" h	CYAP 364836RE S	1	4	No	1	4	No	2465	2535	2850	3200	Contact Factory	
36 x 48 X 42" h	CYAP 364842RE S	1	4	No	1	4	No	2600	2670	2985	3335	Contact Factory	
36 x 60 X 18" h	CYAP 366018RE S	1	4	No	1	4	No	2330	2410	2830	3265	Contact Factory	
36 x 60 X 29" h	CYAP 366029RE S	1	4	No	1	4	No	2465	2545	2965	3400	Contact Factory	
36 x 60 X 36" h	CYAP 366036RE S	1	4	No	1	4	No	2600	2680	3100	3535	Contact Factory	
36 x 60 X 42" h	CYAP 366042RE S	1	4	No	1	4	No	2735	2815	3235	3670	Contact Factory	
36 x 72 X 18" h	CYAP 367218RE S	1	4	No	1	4	No	2465	2560	3085	3620	Contact Factory	
36 x 72 X 29" h	CYAP 367229RE S	1	4	No	1	4	No	2600	2695	3220	3755	Contact Factory	
36 x 72 X 36" h	CYAP 367236RE S	1	4	No	1	4	No	2735	2830	3355	3890	Contact Factory	
36 x 72 X 42" h	CYAP 367242RE S	1	4	No	1	4	No	2870	2965	3490	4025	Contact Factory	
36 x 84 X 18" h	CYAP 368418RE S	1	4	Yes	1	4	Yes	3265	3390	4085	4790	Contact Factory	
36 x 84 X 29" h	CYAP 368429RE S	1	4	Yes	1	4	Yes	3400	3525	4220	4925	Contact Factory	
36 x 84 X 36" h	CYAP 368436RE S	1	4	Yes	1	4	Yes	3535	3660	4355	5060	Contact Factory	
36 x 84 X 42" h	CYAP 368442RE S	1	4	Yes	1	4	Yes	3670	3795	4490	5195	Contact Factory	
36 x 96 X 18" h	CYAP 369618RE S	1	4	Yes	1	4	Yes	3320	3450	4155	4860	Contact Factory	
36 x 96 X 29" h	CYAP 369629RE S	1	4	Yes	1	4	Yes	3455	3585	4290	4995	Contact Factory	
36 x 96 X 36" h	CYAP 369636RE S	1	4	Yes	1	4	Yes	3590	3720	4425	5130	Contact Factory	
36 x 96 X 42" h	CYAP 369642RE S	1	4	Yes	1	4	Yes	3725	3855	4560	5265	Contact Factory	
36 x 120 X 18" h	CYAP 3612018RE S	1	6	Yes	1	6	Yes	4635	4795	5830	6605	Contact Factory	
36 x 120 X 29" h	CYAP 3612029RE S	1	6	Yes	1	6	Yes	5550	5710	6745	7520	Contact Factory	
36 x 120 X 36" h	CYAP 3612036RE S	1	6	Yes	1	6	Yes	5780	5940	6975	7750	Contact Factory	
36 x 120 X 42" h	CYAP 3612042RE S	1	6	Yes	1	6	Yes	6035	6195	7230	8005	Contact Factory	

BASE OPTIONS: [page 45 for base heights]

Alternate table height shorter than 29" (stationary tables only)
 Alternate table height taller than 29" (stationary tables only)

Locking Casters (ADDS 2" TO HEIGHT OF TABLE)

Add Foot Rail to shorter than 84" long tables

Self-Adjustable Glides

TABLE OPTIONS:

Custom Stain for wood edges and veneers

Premium Laminate

Premium Edge-banding

POWER & AVV OPTIONS: [page 21-38]

Non-powered round ABS plastic Grommet (black or silver) | List location code on page 18

Non-powered rectangle metal Grommet (black or silver) | List location code on page 18

WIRE MANAGEMENT: [page 40 - 42]

Customer specified hole cut into top

Vertical ABS Leg Way for table base (black or silver)

36" long Horizontal 4 track Extruded Raceway

MODEL CODE

SC
 TC - 24" & 30" deep tables
 TC - 36" deep tables
 CS
 FT
 SAGS

UCS
 UCL
 UCE

G (B/S)
 GV (B/S)

CNC
 WR (B/S)
 HW

LIST PRICE

\$750 per table (Add 2week lead time)
 \$750 per table (Add 2week lead time)
 \$750 per table (Add 2week lead time)
 \$80 list per table
 \$550 list per table
 \$100 per base

\$600 per color
 Contact Factory
 Contact Factory

\$20 per grommet
 \$120 per grommet

\$250 set up fee per template
 \$25 list per piece
 \$80 per piece



How to Order:

Email orders to: sales@hi5furniture.com

1. Choose your base model
2. Add edge code to base model
3. Choose finishes
4. Select options to add to table
5. Select finishes of options



Shown with Footrail



Shown without Footrail

Laminate & FormaWrap Tables

L3	L6	L7	L17	L20	L21	L22	L26	L33	L34	L35
				Veneer			Back Painted Glass		Solid Surfaces	

Table Size	Model Code:	Top QTY	Post Base QTY	Foot Rail						
48 x 60 X 18" h	CYAP 486018RE S	1	4	No	2520	2605	3400	3970	Contact Factory	
48 x 60 X 29" h	CYAP 486029RE S	1	4	No	2655	2740	3535	4105	Contact Factory	
48 x 60 X 36" h	CYAP 486036RE S	1	4	No	2790	2875	3670	4240	Contact Factory	
48 x 60 X 42" h	CYAP 486042RE S	1	4	No	2925	3010	3805	4375	Contact Factory	
48 x 72 X 18" h	CYAP 487218RE S	1	4	No	2655	2755	3730	4420	Contact Factory	
48 x 72 X 29" h	CYAP 487229RE S	1	4	No	2790	2890	3865	4555	Contact Factory	
48 x 72 X 36" h	CYAP 487236RE S	1	4	No	2925	3025	4000	4690	Contact Factory	
48 x 72 X 42" h	CYAP 487242RE S	1	4	No	3060	3160	4135	4825	Contact Factory	
48 x 84 X 18" h	CYAP 488418RE S	1	4	Yes	3455	3585	4890	5815	Contact Factory	
48 x 84 X 29" h	CYAP 488429RE S	1	4	Yes	3590	3720	5025	5950	Contact Factory	
48 x 84 X 36" h	CYAP 488436RE S	1	4	Yes	3725	3855	5160	6085	Contact Factory	
48 x 84 X 42" h	CYAP 488442RE S	1	4	Yes	3860	3990	5295	6220	Contact Factory	
48 x 96 X 18" h	CYAP 489618RE S	1	4	Yes	3515	3650	4940	5870	Contact Factory	
48 x 96 X 29" h	CYAP 489629RE S	1	4	Yes	3650	3785	5075	6005	Contact Factory	
48 x 96 X 36" h	CYAP 489636RE S	1	4	Yes	3785	3920	5210	6140	Contact Factory	
48 x 96 X 42" h	CYAP 489642RE S	1	4	Yes	3920	4055	5345	6275	Contact Factory	

BASE OPTIONS: [page 45 for base heights]

- Alternate table height shorter than 29" (stationary tables only)
- Alternate table height taller than 29" (stationary tables only)

- Locking Casters (ADDS 2" TO HEIGHT OF TABLE)
- Add Foot Rail to shorter than 84" long tables
- Self-Adjustable Glides

TABLE OPTIONS:

- Custom Stain for wood edges and veneers
- Premium Laminate
- Premium Edge-banding

POWER & AVV OPTIONS: [page 21-38]

- Non-powered round ABS plastic Grommet (black or silver) | List location code on page 18
- Non-powered rectangle metal Grommet (black or silver) | List location code on page 18

WIRE MANAGEMENT: [page 40 - 42]

- Customer specified hole cut into top
- Vertical ABS Leg Way for table base (black or silver)
- 36" long Horizontal 4 track Extruded Raceway

MODEL CODE

- SC
- TC - 24" & 30" deep tables
- TC - 36" deep tables
- CS
- FT
- SAGS

LIST PRICE

- \$750 per table (Add 2week lead time)
- \$750 per table (Add 2week lead time)
- \$750 per table (Add 2week lead time)
- \$80 list per table
- \$550 list per table
- \$100 per base

- UCS
- UCL
- UCE

- \$600 per color
- Contact Factory
- Contact Factory

- G (B/S)
- GV (B/S)

- \$20 per grommet
- \$120 per grommet

- CNC
- WR (B/S)
- HW

- \$250 set up fee per template
- \$25 list per piece
- \$80 per piece

Coby Options

Below are options that are available on all Coby tables.



DIVIDER / PRIVACY PANELS: [page 46]

(1/2" thick x 16" high Clear frosted acrylic panels) Model Code: DPA

24" panel	\$720 list price	60" panel	\$1495 list price
30" panel	\$970 list price	66" panel	\$1550 list price
36" panel	\$1025 list price	72" panel	\$1905 list price
42" panel	\$1380 list price	84" panel	\$2620 list price
48" panel	\$1385 list price	96" panel	\$2625 list price

BASE OPTIONS: [page 45 for base heights]

Self-Adjusting Glides

MODEL CODE

LIST PRICE

SAGS \$100 per base

TABLE OPTIONS:

Custom Stain for wood edges and veneers
Premium Laminate
Premium Edge-banding

UCS \$600 per color
UCL Contact Factory
UCE Contact Factory

POWER & AV OPTIONS : [page 21- 38]

Non-powered round ABS plastic Grommet (black or silver) | List location code on page 18
Non-powered rectangular metal Grommet (black or silver) | List location code on page 18

G (B/S) \$20 per grommet
GV (B/S) \$120 per grommet

WIRE MANAGEMENT: [page 40 - 42]

Vertical ABS Leg Way for table base (black or silver)
36" long Horizontal 4 track Extruded Raceway
12" wide x 34" wide Horizontal Conference Trough
J-channel that attaches to Metal Modesty Panel

WRS/B \$25 list per piece
WH \$80 per piece
WT \$475 list per Tray
WJ \$210 list per table

ACCESSORIES: [pages 39 - 49 for options]

Table Gangers (per set) (N/A on wood edge tops)
Fixed CPU holder width adjustment 2.75" x 5.25"
Fixed CPU holder width adjustment 5.5" x 9.25"
Swivel CPU holder width adjustment 2.75" x 5.25"
Swivel CPU holder width adjustment 5.5" x 9.25"

TG \$135 per set
C1 \$160 per holder
C2 \$160 per holder
C3 \$260 per holder
C4 \$260 per holder

MODESTY PANELS: 9" High straight panels [page 39]

Laminate (Model Code: ML)		Metal (Model Code: MM)	
30" panel	\$210 list price	30" panel	\$185 list price
36" panel	\$230 list price	36" panel	\$190 list price
42" panel	\$240 list price	42" panel	\$225 list price
48" panel	\$250 list price	48" panel	\$230 list price
60" panel	\$270 list price	60" panel	\$245 list price
72" panel	\$300 list price	72" panel	\$265 list price

CONTACT FACTORY FOR LAYOUT, SIZE OPTIONS AND SPECIFICATION ASSISTANCE

Example Base Product Code :

CY SQ 3060 RE S L3 - Options in
Product Base Top Top Table Top Alphabetical Order
Line style size shape function edge

Finish Selections:

BK 7909-60 BK
Base Top Laminate or Edge
Finish Veneer Selection Color

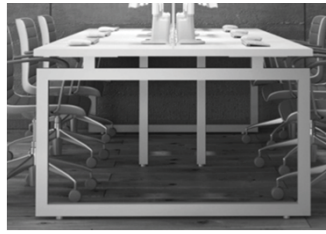

How to Order:

Email orders to: sales@hi5furniture.com

1. Choose your base model
2. Add edge code to base model
3. Choose finishes
4. Select options to add to table
5. Select finishes of options

NOTE: A* Anti-Sag Feature is standard

Laminate & FormaWrap Tables



Table Size	Model Code:	Center			Top QTY	Leg QTY	Base QTY	L1	L2	L3	L4	L5	L6	L7	L8	L9	L10	L11	L12	L13	L14	L15	L16	L17	L18	L19	L20	L21	L22	L23	L24	L25	L26	L27	L28	L29	L30	L31	L32	L33	L34	L35	L36	L37	Category
		QTY	QTY	QTY																																									
24 x 42 X 29"	CYSQ 244229RE S	1	0	2	1695	1750	1915	2105	Contact Factory																																				
24 x 42 X 36"	CYSQ 244236RE S	1	0	2	3365	3420	3585	3775	Contact Factory																																				
24 x 42 X 42"	CYSQ 244242RE S	1	0	2	3365	3420	3585	3775	Contact Factory																																				
24 x 48 X 29"	CYSQ 244829RE S	1	0	2	1700	1760	1955	2175	Contact Factory																																				
24 x 48 X 36"	CYSQ 244836RE S	1	0	2	3370	3430	3625	3845	Contact Factory																																				
24 x 48 X 42"	CYSQ 244842RE S	1	0	2	3370	3430	3625	3845	Contact Factory																																				
24 x 60 X 29"	CYSQ 246029RE S	1	0	2	1770	1835	2100	2370	Contact Factory																																				
24 x 60 X 36"	CYSQ 246036RE S	1	0	2	3440	3505	3770	4040	Contact Factory																																				
24 x 60 X 42"	CYSQ 246042RE S	1	0	2	3440	3505	3770	4040	Contact Factory																																				
24 x 66 X 29"	CYSQ 246629RE S	1	A*	2	1925	2000	2340	2670	Contact Factory																																				
24 x 66 X 36"	CYSQ 246636RE S	1	A*	2	3595	3670	4010	4340	Contact Factory																																				
24 x 66 X 42"	CYSQ 246642RE S	1	A*	2	3595	3670	4010	4340	Contact Factory																																				
24 x 72 X 29"	CYSQ 247229RE S	1	A*	2	1930	2010	2345	2680	Contact Factory																																				
24 x 72 X 36"	CYSQ 247236RE S	1	A*	2	3600	3680	4015	4350	Contact Factory																																				
24 x 72 X 42"	CYSQ 247242RE S	1	A*	2	3600	3680	4015	4350	Contact Factory																																				
24 x 84 X 29"	CYSQ 248429RE S	1	2	2	2305	2385	2970	3405	Contact Factory																																				
24 x 84 X 36"	CYSQ 248436RE S	1	2	2	4175	4255	4840	5275	Contact Factory																																				
24 x 84 X 42"	CYSQ 248442RE S	1	2	2	4175	4255	4840	5275	Contact Factory																																				
24 x 96 X 29"	CYSQ 249629RE S	1	2	2	2310	2405	2980	3415	Contact Factory																																				
24 x 96 X 36"	CYSQ 249636RE S	1	2	2	4180	4275	4850	5285	Contact Factory																																				
24 x 96 X 42"	CYSQ 249642RE S	1	2	2	4180	4275	4850	5285	Contact Factory																																				
24 x 108 X 29"	CYSQ 2410829RE S	1	2	2	2420	2530	3800	3800	Contact Factory																																				
24 x 108 X 36"	CYSQ 2410836RE S	1	2	2	4290	4400	5670	5670	Contact Factory																																				
24 x 108 X 42"	CYSQ 2410842RE S	1	2	2	4290	4400	5670	5670	Contact Factory																																				
24 x 120 X 29"	CYSQ 2412029RE S	1	2	2	2860	2970	4240	4240	Contact Factory																																				
24 x 120 X 36"	CYSQ 2412036RE S	1	2	2	4730	4840	6110	6110	Contact Factory																																				
24 x 120 X 42"	CYSQ 2412042RE S	1	2	2	4730	4840	6110	6110	Contact Factory																																				
24 x 144 X 29"	CYSQ 2414429RE S	2	6	2	3405	3530	4425	5075	Contact Factory																																				
24 x 144 X 36"	CYSQ 2414436RE S	2	6	2	5675	5800	6695	7345	Contact Factory																																				
24 x 144 X 42"	CYSQ 2414442RE S	2	6	2	5675	5800	6695	7345	Contact Factory																																				

BASE OPTIONS: [page 45 for base heights]

Self-Adjusting Glides

MODEL CODE

SAGS

LIST PRICE

\$100 per base

TABLE OPTIONS:

Custom Stain for wood edges UCS

\$600 per color

Premium Laminate

UCL

Contact Factory

Premium Edge-banding

UCE

Contact Factory

POWER & AV OPTIONS: [page 21- 38]

Non-powered round ABS plastic Grommet (black or silver) | List location code on page 18

G (B/S)

\$20 per grommet

Non-powered rectangle metal Grommet (black or silver) | List location code on page 18

GV (B/S)

\$120 per grommet

WIRE MANAGEMENT: [page 40 - 42]

Vertical ABS Leg Way for table base (black or silver)

WRS/B

\$25 list per piece

36" long Horizontal 4 track Extruded Raceway

WH

\$80 per piece

12" wide x 34" wide Horizontal Conference Trough

WT

\$475 list per Tray

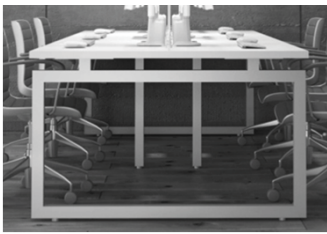

How to Order:
Email orders to: sales@hi5furniture.com
1. Choose your base model
2. Add edge code to base model
3. Choose finishes
4. Select options to add to table
5. Select finishes of options

NOTE: A* Anti-Sag Feature is standard

Laminate & FormaWrap Tables

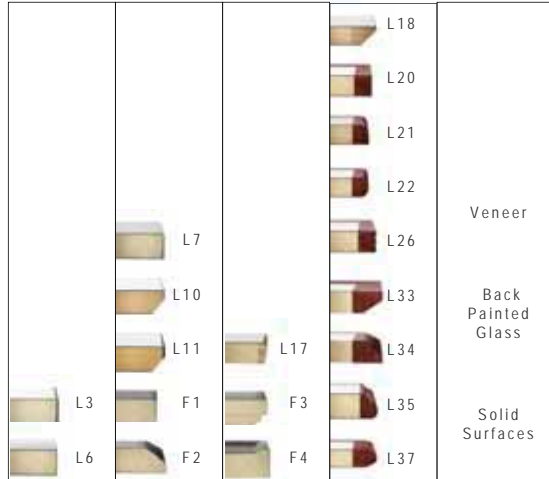

Table Size	Model Code:	Center			Top QTY	Leg QTY	Base QTY	L3	L6	L7	L10	L11	L17	L20	L21	L22	L26	L33	L34	L35	L37		
		Top QTY	Leg QTY	Base QTY																			
30 x 42 X 29"	CYSQ 304229RE S	1	0	2	1900	1965	2045	2510															Contact Factory
30 x 42 X 36"	CYSQ 304236RE S	1	0	2	3570	3635	3715	4180															Contact Factory
30 x 42 X 42"	CYSQ 304242RE S	1	0	2	3570	3635	3715	4180															Contact Factory
30 x 48 X 29"	CYSQ 304829RE S	1	0	2	1900	1965	2045	2510															Contact Factory
30 x 48 X 36"	CYSQ 304836RE S	1	0	2	3570	3635	3715	4180															Contact Factory
30 x 48 X 42"	CYSQ 304842RE S	1	0	2	3570	3635	3715	4180															Contact Factory
30 x 60 X 29"	CYSQ 306029RE S	1	0	2	1980	2055	2395	2760															Contact Factory
30 x 60 X 36"	CYSQ 306036RE S	1	0	2	3650	3725	4065	4430															Contact Factory
30 x 60 X 42"	CYSQ 306042RE S	1	0	2	3650	3725	4065	4430															Contact Factory
30 x 72 X 29"	CYSQ 307229RE S	1	A*	2	2160	2245	2670	3120															Contact Factory
30 x 72 X 36"	CYSQ 307236RE S	1	A*	2	3830	3915	4340	4790															Contact Factory
30 x 72 X 42"	CYSQ 307242RE S	1	A*	2	3830	3915	4340	4790															Contact Factory
30 x 84 X 29"	CYSQ 308429RE S	1	2	2	2525	2615	3355	3940															Contact Factory
30 x 84 X 36"	CYSQ 308436RE S	1	2	2	4395	4485	5225	5810															Contact Factory
30 x 84 X 42"	CYSQ 308442RE S	1	2	2	4395	4485	5225	5810															Contact Factory
30 x 96 X 29"	CYSQ 309629RE S	1	2	2	2535	2635	3360	3960															Contact Factory
30 x 96 X 36"	CYSQ 309636RE S	1	2	2	4405	4505	5230	5830															Contact Factory
30 x 96 X 42"	CYSQ 309642RE S	1	2	2	4405	4505	5230	5830															Contact Factory
30 x 108 X 29"	CYSQ 3010829RE S	1	2	2	2660	2780	3510	4460															Contact Factory
30 x 108 X 36"	CYSQ 3010836RE S	1	2	2	4530	4650	5380	6330															Contact Factory
30 x 108 X 42"	CYSQ 3010842RE S	1	2	2	4530	4650	5380	6330															Contact Factory
30 x 120 X 29"	CYSQ 3012029RE S	1	2	2	3100	3220	3950	4900															Contact Factory
30 x 120 X 36"	CYSQ 3012036RE S	1	2	2	4970	5090	5820	6770															Contact Factory
30 x 120 X 42"	CYSQ 3012042RE S	1	2	2	4970	5090	5820	6770															Contact Factory
30 x 144 X 29"	CYSQ 3014429RE S	2	6	2	3670	3800	4935	5810															Contact Factory
30 x 144 X 36"	CYSQ 3014436RE S	2	6	2	5940	6070	7205	8080															Contact Factory
30 x 144 X 42"	CYSQ 3014442RE S	2	6	2	5940	6070	7205	8080															Contact Factory

BASE OPTIONS: [page 45 for base heights]

Self-Adjusting Glides

MODEL CODE

SAGS

LIST PRICE

\$100 per base

TABLE OPTIONS:

Custom Stain for wood edges UCS

\$600 per color

Premium Laminate

UCL

Contact Factory

Premium Edge-banding

UCE

Contact Factory

POWER & A/V OPTIONS: [page 21-38]

Non-powered round ABS plastic Grommet (black or silver) | List location code on page 18

G (B/S)

\$20 per grommet

Non-powered rectangle metal Grommet (black or silver) | List location code on page 18

GV (B/S)

\$120 per grommet

WIRE MANAGEMENT: [page 40 - 42]

Vertical ABS Leg Way for table base (black or silver)

WRS/B

\$25 list per piece

36" long Horizontal 4 track Extruded Raceway

WH

\$80 per piece

12" wide x 34" wide Horizontal Conference Trough

WT

\$475 list per Tray



How to Order:
 Email orders to: sales@hi5furniture.com
 1. Choose your base model
 2. Add edge code to base model
 3. Choose finishes
 4. Select options to add to table
 5. Select finishes of options

NOTE: A* Anti-Sag Feature is standard

Laminate & FormaWrap Tables

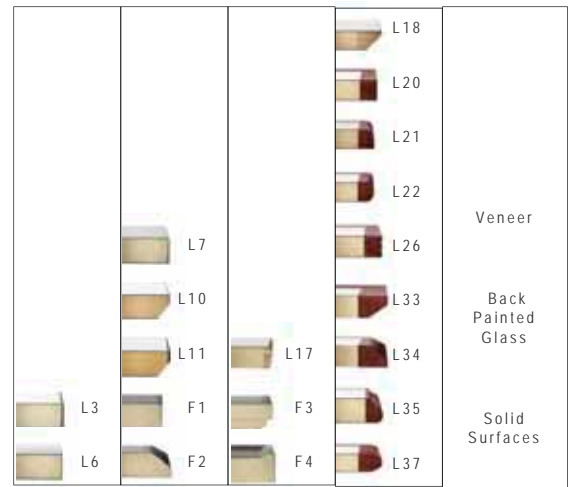

Table Size	Model Code:	Top QTY	Center Leg QTY	Base QTY						
36 x 42 X 29"	CYSQ 364229RE S	1	0	2	2235	2305	2620	2970	Contact Factory	
36 x 42 X 36"	CYSQ 364236RE S	1	0	2	3905	3975	4290	4640	Contact Factory	
36 x 42 X 42"	CYSQ 364242RE S	1	0	2	3905	3975	4290	4640	Contact Factory	
36 x 48 X 29"	CYSQ 364829RE S	1	0	2	2235	2305	2620	2970	Contact Factory	
36 x 48 X 36"	CYSQ 364836RE S	1	0	2	3905	3975	4290	4640	Contact Factory	
36 x 48 X 42"	CYSQ 364842RE S	1	0	2	3905	3975	4290	4640	Contact Factory	
36 x 60 X 29"	CYSQ 366029RE S	1	0	2	2330	2410	2830	3265	Contact Factory	
36 x 60 X 36"	CYSQ 366036RE S	1	0	2	4000	4080	4500	4935	Contact Factory	
36 x 60 X 42"	CYSQ 366042RE S	1	0	2	4000	4080	4500	4935	Contact Factory	
36 x 72 X 29"	CYSQ 367229RE S	1	A*	2	2520	2615	3140	3675	Contact Factory	
36 x 72 X 36"	CYSQ 367236RE S	1	A*	2	4190	4285	4810	5345	Contact Factory	
36 x 72 X 42"	CYSQ 367242RE S	1	A*	2	4190	4285	4810	5345	Contact Factory	
36 x 84 X 29"	CYSQ 368429RE S	1	2	2	3190	3315	4010	4715	Contact Factory	
36 x 84 X 36"	CYSQ 368436RE S	1	2	2	5060	5185	5880	6585	Contact Factory	
36 x 84 X 42"	CYSQ 368442RE S	1	2	2	5060	5185	5880	6585	Contact Factory	
36 x 96 X 29"	CYSQ 369629RE S	1	2	2	3200	3330	4035	4740	Contact Factory	
36 x 96 X 36"	CYSQ 369636RE S	1	2	2	5070	5200	5905	6610	Contact Factory	
36 x 96 X 42"	CYSQ 369642RE S	1	2	2	5070	5200	5905	6610	Contact Factory	
36 x 108 X 29"	CYSQ 3610829RE S	1	2	2	3385	3545	4580	5355	Contact Factory	
36 x 108 X 36"	CYSQ 3610836RE S	1	2	2	5255	5415	6450	7225	Contact Factory	
36 x 108 X 42"	CYSQ 3610842RE S	1	2	2	5255	5415	6450	7225	Contact Factory	
36 x 120 X 29"	CYSQ 3612029RE S	1	2	2	3945	4105	5140	5915	Contact Factory	
36 x 120 X 36"	CYSQ 3612036RE S	1	2	2	5815	5975	7010	7785	Contact Factory	
36 x 120 X 42"	CYSQ 3612042RE S	1	2	2	5815	5975	7010	7785	Contact Factory	
36 x 144 X 29"	CYSQ 3614429RE S	2	6	2	4690	4875	5975	7025	Contact Factory	
36 x 144 X 36"	CYSQ 3614436RE S	2	6	2	6960	7145	8245	9295	Contact Factory	
36 x 144 X 42"	CYSQ 3614442RE S	2	6	2	6960	7145	8245	9295	Contact Factory	

BASE OPTIONS: [page 45 for base heights]

Self-Adjusting Glides

MODEL CODE

SAGS

LIST PRICE

\$100 per base

TABLE OPTIONS:

Custom Stain for wood edges UCS

\$600 per color

Premium Laminate

UCL

Contact Factory

Premium Edge-banding

UCE

Contact Factory

POWER & AV OPTIONS: [page 21- 38]

Non-powered round ABS plastic Grommet (black or silver) | List location code on page 18

G (B/S)

\$20 per grommet

Non-powered rectangle metal Grommet (black or silver) | List location code on page 18

GV (B/S)

\$120 per grommet

WIRE MANAGEMENT: [page 40 - 42]

Vertical ABS Leg Way for table base (black or silver)

WRS/B

\$25 list per piece

36" long Horizontal 4 track Extruded Raceway

WH

\$80 per piece

12" wide x 34" wide Horizontal Conference Trough

WT

\$475 list per Tray



- How to Order:**
 Email orders to: sales@hi5furniture.com
 1. Choose your base model
 2. Add edge code to base model
 3. Choose finishes
 4. Select options to add to table
 5. Select finishes of options

NOTE: A* Anti-Sag Feature is standard

Laminate Tables

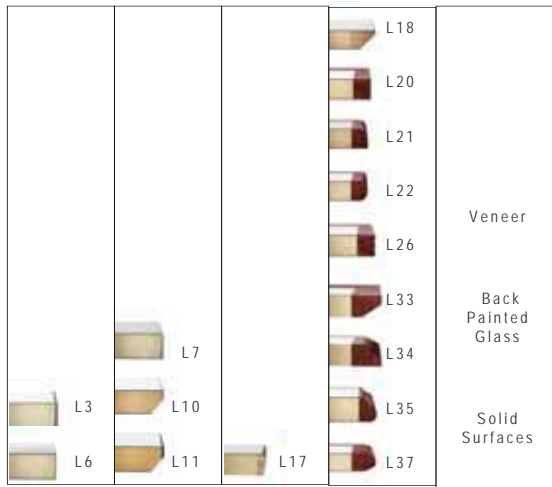

Table Size	Model Code	Center			L3	L6	L7	L10	L11	L17	L18	L20	L21	L22	L26	L33	L34	L35	L37	
		Top QTY	Leg QTY	Base QTY																
48 x 60 x 29"	CYSQ 486029RE S	1	0	2	2970	3055	3850	4420	Contact Factory											
48 x 60 x 36"	CYSQ 486036RE S	1	0	2	4640	4725	5520	6090	Contact Factory											
48 x 60 x 42"	CYSQ 486042RE S	1	0	2	4640	4725	5520	6090	Contact Factory											
48 x 72 x 29"	CYSQ 487229RE S	1	A*	2	3160	3260	4235	4925	Contact Factory											
48 x 72 x 36"	CYSQ 487236RE S	1	A*	2	4830	4930	5905	6595	Contact Factory											
48 x 72 x 42"	CYSQ 487242RE S	1	A*	2	4830	4930	5905	6595	Contact Factory											
48 x 84 x 29"	CYSQ 488429RE S	1	2	2	3710	3840	5145	6070	Contact Factory											
48 x 84 x 36"	CYSQ 488436RE S	1	2	2	5580	5710	7015	7940	Contact Factory											
48 x 84 x 42"	CYSQ 488442RE S	1	2	2	5580	5710	7015	7940	Contact Factory											
48 x 96 x 29"	CYSQ 489629RE S	1	2	2	3845	3860	5150	6080	Contact Factory											
48 x 96 x 36"	CYSQ 489636RE S	1	2	2	5715	5730	7020	7950	Contact Factory											
48 x 96 x 42"	CYSQ 489642RE S	1	2	2	5715	5730	7020	7950	Contact Factory											
48 x 108 x 29"	CYSQ 4810829RE S	1	2	2	3895	4055	5840	6870	Contact Factory											
48 x 108 x 36"	CYSQ 4810836RE S	1	2	2	5765	5925	7710	8740	Contact Factory											
48 x 108 x 42"	CYSQ 4810842RE S	1	2	2	5765	5925	7710	8740	Contact Factory											
48 x 120 x 29"	CYSQ 4812029RE S	1	2	2	4350	4510	6290	7320	Contact Factory											
48 x 120 x 36"	CYSQ 4812036RE S	1	2	2	6220	6380	8160	9190	Contact Factory											
48 x 120 x 42"	CYSQ 4812042RE S	1	2	2	6220	6380	8160	9190	Contact Factory											
48 x 144 x 29"	CYSQ 4814429RE S	2	6	2	4975	5160	7310	8580	Contact Factory											
48 x 144 x 36"	CYSQ 4814436RE S	2	6	2	7245	7430	9580	10,850	Contact Factory											
48 x 144 x 42"	CYSQ 4814442RE S	2	6	2	7245	7430	9580	10,850	Contact Factory											
48 x 168 x 29"	CYSQ 4816829RE S	2	6	2	5630	5915	7910	9360	Contact Factory											
48 x 168 x 36"	CYSQ 4816836RE S	2	6	2	7900	8185	10,180	11,630	Contact Factory											
48 x 168 x 42"	CYSQ 4816842RE S	2	6	2	7900	8185	10,180	11,630	Contact Factory											
48 x 192 x 29"	CYSQ 4819229RE S	2	6	2	5660	5950	8505	10,165	Contact Factory											
48 x 192 x 36"	CYSQ 4819236RE S	2	6	2	7930	8220	10,775	12,435	Contact Factory											
48 x 192 x 42"	CYSQ 4819242RE S	2	6	2	7930	8220	10,775	12,435	Contact Factory											
48 x 216 x 29"	CYSQ 4821629RE S	2	6	2	6030	6380	9690	11,775	Contact Factory											
48 x 216 x 36"	CYSQ 4821636RE S	2	6	2	8300	8650	11,960	14,045	Contact Factory											
48 x 216 x 42"	CYSQ 4821642RE S	2	6	2	8300	8650	11,960	14,045	Contact Factory											
48 x 240 x 29"	CYSQ 4824029RE S	2	6	2	6090	6440	9695	11,880	Contact Factory											
48 x 240 x 36"	CYSQ 4821636RE S	2	6	2	8360	8710	11,965	14,150	Contact Factory											
48 x 240 x 42"	CYSQ 4821642RE S	2	6	2	8360	8710	11,965	14,150	Contact Factory											

BASE OPTIONS: [page 45 for base heights]
 Self-Adjusting Glides

MODEL CODE LIST PRICE
 SAGS \$100 per base

POWER & A/V OPTIONS: [page 21-38]
 Non-powered round ABS plastic Grommet (black or silver) | List location code on page 18
 Non-powered rectangle metal Grommet (black or silver) | List location code on page 18

G (B/S) \$20 per grommet
 GV (B/S) \$120 per grommet

WIRE MANAGEMENT: [page 40 - 42]
 Vertical ABS Leg Way for table base (black or silver)
 36" long Horizontal 4 track Extruded Raceway
 12" wide x 34" wide Horizontal Conference Trough

WRS/B \$25 list per piece
 WH \$80 per piece
 WT \$475 list per Tray



How to Order:
 Email orders to: sales@hi5furniture.com
 1. Choose your base model
 2. Add edge code to base model
 3. Choose finishes
 4. Select options to add to table
 5. Select finishes of options

NOTE: A* Anti-Sag Feature is standard

Laminate Tables



Table Size	Model Code:	Top QTY	Center Leg QTY	Base QTY					
60 x 72 x 29"	CYSQ 607229RE S	1	A*	2	3445	3565	4900	5675	Contact Factory
60 x 72 x 36"	CYSQ 607236RE S	1	A*	2	5115	5235	6570	7345	Contact Factory
60 x 72 x 42"	CYSQ 607242RE S	1	A*	2	5115	5235	6570	7345	Contact Factory
60 x 84 x 29"	CYSQ 608429RE S	1	2	2	4030	4190	5985	7020	Contact Factory
60 x 84 x 36"	CYSQ 608436RE S	1	2	2	5900	6060	7855	8890	Contact Factory
60 x 84 x 42"	CYSQ 608442RE S	1	2	2	5900	6060	7855	8890	Contact Factory
60 x 96 x 29"	CYSQ 609629RE S	1	2	2	4045	4205	5990	7030	Contact Factory
60 x 96 x 36"	CYSQ 609636RE S	1	2	2	5915	6075	7860	8900	Contact Factory
60 x 96 x 42"	CYSQ 609642RE S	1	2	2	5915	6075	7860	8900	Contact Factory
60 x 108 x 29"	CYSQ 6010829RE S	1	2	2	4255	4445	6730	8025	Contact Factory
60 x 108 x 36"	CYSQ 6010836RE S	1	2	2	6125	6315	8600	9895	Contact Factory
60 x 108 x 42"	CYSQ 6010842RE S	1	2	2	6125	6315	8600	9895	Contact Factory
60 x 120 x 29"	CYSQ 6012029RE S	1	4	2	4710	4900	7180	8470	Contact Factory
60 x 120 x 36"	CYSQ 6012036RE S	1	4	2	6580	6770	9050	10,340	Contact Factory
60 x 120 x 42"	CYSQ 6012042RE S	1	4	2	6580	6770	9050	10,340	Contact Factory
60 x 144 x 29"	CYSQ 6014429RE S	2	6	2	5370	5595	8380	9930	Contact Factory
60 x 144 x 36"	CYSQ 6014436RE S	2	6	2	7640	7865	10,650	12,200	Contact Factory
60 x 144 x 42"	CYSQ 6014442RE S	2	6	2	7640	7865	10,650	12,200	Contact Factory
60 x 168 x 29"	CYSQ 6016829RE S	2	6	2	6140	6480	9100	10,915	Contact Factory
60 x 168 x 36"	CYSQ 6016836RE S	2	6	2	8410	8750	11,370	13,185	Contact Factory
60 x 168 x 42"	CYSQ 6016842RE S	2	6	2	8410	8750	11,370	13,185	Contact Factory
60 x 192 x 29"	CYSQ 6019229RE S	2	6	2	6170	6510	9845	11,925	Contact Factory
60 x 192 x 36"	CYSQ 6019236RE S	2	6	2	8440	8780	12,115	14,195	Contact Factory
60 x 192 x 42"	CYSQ 6019242RE S	2	6	2	8440	8780	12,115	14,195	Contact Factory
60 x 216 x 29"	CYSQ 6021629RE S	2	6	2	6630	7040	10,595	12,930	Contact Factory
60 x 216 x 36"	CYSQ 6021636RE S	2	6	2	8900	9310	12,865	15,200	Contact Factory
60 x 216 x 42"	CYSQ 6021642RE S	2	6	2	8900	9310	12,865	15,200	Contact Factory
60 x 240 x 29"	CYSQ 6024029RE S	2	6	2	6680	7105	11,340	13,935	Contact Factory
60 x 240 x 36"	CYSQ 6024036RE S	2	6	2	8950	9375	13,610	16,205	Contact Factory
60 x 240 x 42"	CYSQ 6024042RE S	2	6	2	8950	9375	13,610	16,205	Contact Factory
60 x 288 x 29"	CYSQ 6028829RE S	3	10	2	8030	8520	13,710	16,825	Contact Factory
60 x 288 x 36"	CYSQ 6028836RE S	3	10	2	10,500	10,990	16,180	19,295	Contact Factory
60 x 288 x 42"	CYSQ 6028842RE S	3	10	2	10,500	10,990	16,180	19,295	Contact Factory

BASE OPTIONS: [page 45 for base heights]

Self-Adjusting Glides

MODEL CODE

SAGS

LIST PRICE

\$100 per base

POWER & A/V OPTIONS: [page 21-38]

Non-powered round ABS plastic Grommet (black or silver) | List location code on page 18

Non-powered rectangle metal Grommet (black or silver) | List location code on page 18

G (B/S)

\$20 per grommet

GV (B/S)

\$120 per grommet

WIRE MANAGEMENT: [page 40 - 42]

Vertical ABS Leg Way for table base (black or silver)

36" long Horizontal 4 track Extruded Raceway

12" wide x 34" wide Horizontal Conference Tray

WRS/B

\$25 list per piece

WH

\$80 per piece

WT

\$475 list per Tray

Empire Options

Below are options that are available on all Empire tables.



BASE OPTIONS: [page 45 for base heights]

- Locking casters for carpet – T Bases
- Locking casters for carpet – X Bases
- Metal to metal connection (stationary tables only)

TABLE OPTIONS:

- Custom Stain for wood edges and veneers
- Premium Laminate
- Premium Edge-banding

POWER & A/V OPTIONS : [page 21- 38]

- Non-powered round ABS plastic Grommet (black or silver) | List location code on page 18
- Non-powered rectangle metal Grommet (black or silver) | List location code on page 18

WIRE MANAGEMENT: [page 40 - 42]

- Customer specified hole cut into top
- Vertical plastic leg way for table base (black)
- Vertical plastic leg way for table base (silver)
- Vertical laser cut holes in table base (stationary tables only)
- Horizontal plastic 4-channel raceway
- Horizontal conference raceway
- Horizontal J-channel that hangs off perforated metal modesty panel

ACCESSORIES: [pages 39 - 49 for options]

- Table Gangers (per set) (N/A on wood edge tops)
- Quick Release Table Gangers
- Flat Plates
- Add Radius Corners – Specify 1", 2", 3", 4", or 5" radius
- Make a 1-piece table top a 2-piece table top (non-height adjustable tables only)
- Anti-sag bar
- Fixed CPU holder width adjustment of 5.5" x 9.25"
- Fixed CPU holder width adjustment of 2.75" x 5.25"
- Swivel CPU holder width adjustment of 5.5" x 9.25"
- Swivel CPU holder width adjustment of 2.75" x 5.25"

MODESTY PANELS: 9" High straight panels [page 39]

Laminate (Model Code: ML)		Metal (Model Code: MM)	
30" panel	\$210 list price	30" panel	\$185 list price
36" panel	\$230 list price	36" panel	\$190 list price
42" panel	\$240 list price	42" panel	\$225 list price
48" panel	\$250 list price	48" panel	\$230 list price
60" panel	\$270 list price	60" panel	\$245 list price
72" panel	\$300 list price	72" panel	\$265 list price

MODEL CODE

CS	\$40 per base
CS	\$80 per base
TI	\$100 per table

UCS	\$600 per color
UCL	contact factory
UCE	contact factory

G (B/S)	\$20 per grommet
GV (B/S)	\$120 per grommet

CNC	\$250 set up fee per template
WR-B	\$25 per base
WR-S	\$25 per base
WB	\$50 per base
WH	\$80 per table
WT	\$475 per table
MMJ	\$210 per table

TG	\$135 per set
QR	\$135 per table
FP	\$20 per plate
RC	\$100 per table
FJ	\$300 for each additional joint on tables 10' and under
AS	\$100 per table
C1	\$160 per holder
C2	\$160 per holder
C3	\$260 per holder
C4	\$260 per holder

CONTACT FACTORY FOR LAYOUT, SIZE OPTIONS AND SPECIFICATION ASSISTANCE

Example Base Product Code :

<u>EE</u>	<u>X1</u>	<u>36</u>	<u>RD</u>	<u>S</u>	<u>L3</u>	- Options in
Product Line	Base style	Top size	Top shape	Table function	Top edge	Alphabetical Order

Finish Selections:

<u>BK</u>	<u>7909-60</u>	<u>BK</u>
Base Finish	Top Laminate or Veneer Selection	Edge Color



Round Top



Square Top

How to Order:

Email orders to: sales@hi5furniture.com

1. Choose your base model
2. Add edge code to base model
3. Choose finishes
4. Select options to add to table
5. Select finishes of options

Laminate & FormaWrap Tables



Table Size	Top Shape	Table Function	Model Code:	Top QTY	Base QTY	Base Spread	Base Style					
24"	round	Stationary	EEX1 24RD S	1	1	22"	X	1040	1145	1165	1185	Contact Factory
24"	round	Pneumatic 27.25" - 45"	EEX1 24RD P	1	1	22"	X	1805	1910	1930	1950	Contact Factory
24"	round	Hand crank 27.25" - 36.75"	EEX1 24RD H	1	1	22"	X	1510	1615	1635	1655	Contact Factory
30"	round	Stationary	EEX1 30RD S	1	1	22"	X	1100	1210	1305	1380	Contact Factory
30"	round	Pneumatic 27.25" - 45"	EEX1 30RD P	1	1	22"	X	1865	1975	2070	2145	Contact Factory
30"	round	Hand crank 27.25" - 36.75"	EEX1 30RD H	1	1	22"	X	1570	1680	1775	1850	Contact Factory
36"	round	Stationary	EEX1 36RD S	1	1	26"	X	1195	1305	1600	1705	Contact Factory
36"	round	Pneumatic 27.25" - 45"	EEX1 36RD P	1	1	26"	X	1955	2065	2360	2465	Contact Factory
36"	round	Hand crank 27.25" - 36.75"	EEX1 36RD H	1	1	26"	X	1655	1765	2060	2165	Contact Factory
42"	round	Stationary	EEX1 42RD S	1	1	32"	X	1230	1345	2020	2510	Contact Factory
42"	round	Pneumatic 27.25" - 45"	EEX1 42RD P	1	1	32"	X	1995	2110	2785	2930	Contact Factory
48"	round	Stationary	EEX1 48RD S	1	1	36"	X	1270	1380	2325	2510	Contact Factory
48"	round	Pneumatic 27.25" - 45"	EEX1 48RD P	1	1	36"	X	2025	2135	3080	3265	Contact Factory
24"	square	Stationary	EEX1 24SQ S	1	1	22"	X	995	1045	1055	1455	Contact Factory
24"	square	Pneumatic 27.25" - 45"	EEX1 24SQ P	1	1	22"	X	1760	1810	1820	1870	Contact Factory
24"	square	Hand crank 27.25" - 36.75"	EEX1 24SQ H	1	1	22"	X	1460	1510	1520	1570	Contact Factory
30"	square	Stationary	EEX1 30SQ S	1	1	22"	X	1050	1105	1230	1320	Contact Factory
30"	square	Pneumatic 27.25" - 45"	EEX1 30SQ P	1	1	26"	X	1840	1895	2020	2110	Contact Factory
30"	square	Hand crank 27.25" - 36.75"	EEX1 30SQ H	1	1	26"	X	1540	1595	1720	1810	Contact Factory
36"	square	Stationary	EEX1 36SQ S	1	1	32"	X	1160	1220	1380	1645	Contact Factory
36"	square	Pneumatic 27.25" - 45"	EEX1 36SQ P	1	1	32"	X	1925	1985	2145	2410	Contact Factory
42"	square	Stationary	EEX1 42SQ S	1	1	36"	X	1180	1250	1630	2075	Contact Factory
42"	square	Pneumatic 27.25" - 45"	EEX1 42SQ P	1	1	36"	X	1965	2035	2415	2860	Contact Factory

BASE OPTIONS: [page 45 for base heights]

- Café Height – 36" High
- Bar Height – 42"
- Locking casters for carpet – T Bases
- Locking casters for carpet – X Bases

TABLE OPTIONS:

- Custom Stain for wood edges and veneers
- Premium Laminate
- Premium Edge-banding

ACCESSORIES: [pages 39 - 49 for options]

- Add Radius Corners – Specify 1", 2", 3", 4", or 5" radius

MODEL CODE

- CH Contact Factory
- BH Contact Factory
- CS \$40 per base
- CS \$80 per base

LIST PRICE

- UCS \$600 per color
- UCL Contact Factory
- UCE Contact Factory

- RC \$100 per table



Round Base



Square Base

How to Order:

Email orders to: sales@hi5furniture.com

1. Choose your base model
2. Add edge code to base model
3. Choose finishes
4. Select options to add to table
5. Select finishes of options

NOTE: Bases include levelers

Table Size	Top Shape	Table Function	Model Code:	Top QTY	Base QTY	Base Spread	Base Style					
24"	round	Pneumatic 27.25" - 45"	EED1 24RD P	1	1	20"	D-Round	2005	2110	2130	2150	Contact Factory
24"	round	Pneumatic 27.25" - 45"	EEQ1 24RD P	1	1	16"	Q-Square	2005	2110	2130	2150	Contact Factory
30"	round	Pneumatic 27.25" - 45"	EED1 30RD P	1	1	20"	D-Round	2065	2175	2270	2345	Contact Factory
30"	round	Pneumatic 27.25" - 45"	EEQ1 30RD P	1	1	16"	Q-Square	2065	2175	2270	2345	Contact Factory
36"	round	Pneumatic 27.25" - 45"	EED1 36RD P	1	1	20"	D-Round	2130	2240	2535	2640	Contact Factory
36"	round	Pneumatic 27.25" - 45"	EEQ1 36RD P	1	1	16"	Q-Square	2130	2240	2535	2640	Contact Factory
42"	round	Pneumatic 27.25" - 45"	EED1 42RD P	1	1	20"	D-Round	2200	2315	2990	3135	Contact Factory
42"	round	Pneumatic 27.25" - 45"	EEQ1 42RD P	1	1	16"	Q-Square	2200	2315	2990	3135	Contact Factory
48"	round	Pneumatic 27.25" - 45"	EED1 48RD P	1	1	32"	D-Round	2375	2485	3430	3615	Contact Factory
48"	round	Pneumatic 27.25" - 45"	EEQ1 48RD P	1	1	26"	Q-Square	2375	2485	3430	3615	Contact Factory
24"	square	Pneumatic 27.25" - 45"	EED1 24SQ P	1	1	20"	D-Round	1955	2005	2015	2065	Contact Factory
24"	square	Pneumatic 27.25" - 45"	EEQ1 24SQ P	1	1	16"	Q-Square	1955	2005	2015	2065	Contact Factory
30"	square	Pneumatic 27.25" - 45"	EED1 30SQ P	1	1	20"	D-Round	2015	2070	2195	2285	Contact Factory
30"	square	Pneumatic 27.25" - 45"	EEQ1 30SQ P	1	1	16"	Q-Square	2015	2070	2195	2285	Contact Factory
36"	square	Pneumatic 27.25" - 45"	EED1 36SQ P	1	1	24"	D-Round	2130	2190	2350	2615	Contact Factory
36"	square	Pneumatic 27.25" - 45"	EEQ1 36SQ P	1	1	20"	Q-Square	2130	2190	2350	2615	Contact Factory
42"	square	Pneumatic 27.25" - 45"	EED1 42SQ P	1	1	32"	D-Round	2315	2385	2765	3210	Contact Factory
42"	square	Pneumatic 27.25" - 45"	EEQ1 42SQ P	1	1	26"	Q-Square	2315	2385	2765	3210	Contact Factory

Laminate & FormaWrap Tables

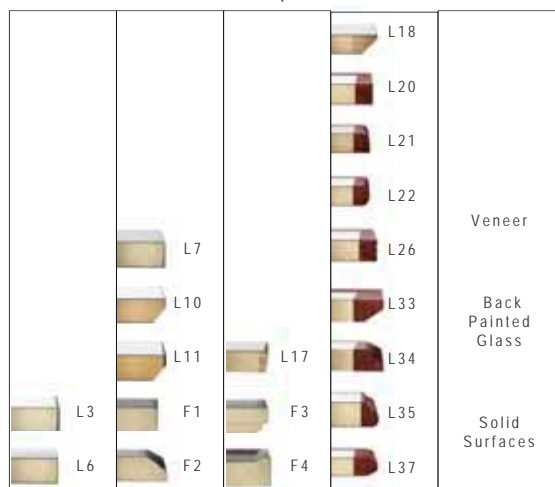

BASE OPTIONS: [page 45 for base heights]

- Café Height – 36" High
- Bar Height – 42"
- Locking casters for carpet – T Bases
- Locking casters for carpet – X Bases

TABLE OPTIONS:

- Custom Stain for wood edges and veneers
- Premium Laminate
- Premium Edge-banding

ACCESSORIES: [pages 39 - 49 for options]

- Add Radius Corners – Specify 1", 2", 3", 4", or 5" radius

MODEL CODE

LIST PRICE

- CH Contact Factory
- BH Contact Factory
- CS \$40 per base
- CS \$80 per base
- UCS \$600 per color
- UCL Contact Factory
- UCE Contact Factory
- RC \$100 per table



How to Order:

- Email orders to: sales@hi5furniture.com
- 1. Choose your base model
- 2. Add edge code to base model
- 3. Choose finishes
- 4. Select options to add to table
- 5. Select finishes of options

Height Adjustment Ranges:

- Pneumatic 27.25" - 45"
- Hand crank 27.25" - 36.75"
- Electric 2 stage 27.75" - 46.75"
- Electric 3 stage 22.25" - 48.25"

Laminate & FormaWrap Tables



Table Size	Top Shape	Table Function	Model Code:	Top QTY	Base QTY	Base Spread	Base Style					
18" x 48"	rectangle	Stationary	EEC1 1848RE S	1	2	18"	C	1100	1160	1355	1595	Contact Factory
18" x 48"	rectangle	Stationary	EET1 1848RE S	1	2	18"	T	1100	1160	1355	1595	Contact Factory
18" x 48"	rectangle	Pneumatic	EEC1 1848RE P	1	2	18"	C	3585	3645	3840	4080	Contact Factory
18" x 48"	rectangle	Pneumatic	EET1 1848RE P	1	2	18"	T	3585	3645	3840	4080	Contact Factory
18" x 48"	rectangle	Hand crank	EEC1 1848RE H	1	2	18"	C	1960	2020	2215	2455	Contact Factory
18" x 48"	rectangle	Hand crank	EET1 1848RE H	1	2	18"	T	1960	2020	2215	2455	Contact Factory
18" x 48"	rectangle	Electric 2 stage	EEC1 1848RE E2	1	2	18"	C	3455	3515	3710	3950	Contact Factory
18" x 48"	rectangle	Electric 2 stage	EET1 1848RE E2	1	2	18"	T	3455	3515	3710	3950	Contact Factory
18" x 48"	rectangle	Electric 3 stage	EEC1 1848RE E3	1	2	18"	C	4150	4215	4480	4770	Contact Factory
18" x 48"	rectangle	Electric 3 stage	EET1 1848RE E3	1	2	18"	T	4150	4215	4480	4770	Contact Factory
18" x 60"	rectangle	Stationary	EEC1 1860RE S	1	2	18"	C	1170	1235	1500	1790	Contact Factory
18" x 60"	rectangle	Stationary	EET1 1860RE S	1	2	18"	T	1170	1235	1500	1790	Contact Factory
18" x 60"	rectangle	Pneumatic	EEC1 1860RE P	1	2	18"	C	3655	3720	3985	4275	Contact Factory
18" x 60"	rectangle	Pneumatic	EET1 1860RE P	1	2	18"	T	3655	3720	3985	4275	Contact Factory
18" x 60"	rectangle	Hand crank	EEC1 1860RE H	1	2	18"	C	2030	2095	2360	2650	Contact Factory
18" x 60"	rectangle	Hand crank	EET1 1860RE H	1	2	18"	T	2030	2095	2360	2650	Contact Factory
18" x 60"	rectangle	Electric 2 stage	EEC1 1860RE E2	1	2	18"	C	3525	3590	3855	4145	Contact Factory
18" x 60"	rectangle	Electric 2 stage	EET1 1860RE E2	1	2	18"	T	3525	3590	3855	4145	Contact Factory
18" x 60"	rectangle	Electric 3 stage	EEC1 1860RE E3	1	2	18"	C	4150	4215	4480	4770	Contact Factory
18" x 60"	rectangle	Electric 3 stage	EET1 1860RE E3	1	2	18"	T	4150	4215	4480	4770	Contact Factory
18" x 72"	rectangle	Stationary	EEC1 1872RE S	1	2	18"	C	2130	1310	1645	2000	Contact Factory
18" x 72"	rectangle	Stationary	EET1 1872RE S	1	2	18"	T	2130	1310	1645	2000	Contact Factory
18" x 72"	rectangle	Pneumatic	EEC1 1872RE P	1	2	18"	C	3715	3795	4130	4485	Contact Factory
18" x 72"	rectangle	Pneumatic	EET1 1872RE P	1	2	18"	T	3715	3795	4130	4485	Contact Factory
18" x 72"	rectangle	Hand crank	EEC1 1872RE H	1	2	18"	C	2090	2170	2505	2860	Contact Factory
18" x 72"	rectangle	Hand crank	EET1 1872RE H	1	2	18"	T	2090	2170	2505	2860	Contact Factory
18" x 72"	rectangle	Electric 2 stage	EEC1 1872RE E2	1	2	18"	C	3585	3665	4000	4355	Contact Factory
18" x 72"	rectangle	Electric 2 stage	EET1 1872RE E2	1	2	18"	T	3585	3665	4000	4355	Contact Factory
18" x 72"	rectangle	Electric 3 stage	EEC1 1872RE E3	1	2	18"	C	4210	4290	4625	4980	Contact Factory
18" x 72"	rectangle	Electric 3 stage	EET1 1872RE E3	1	2	18"	T	4210	4290	4625	4980	Contact Factory

BASE OPTIONS: [page 45 for base heights]

Locking casters for carpet - T Bases

MODEL CODE LIST PRICE

CS \$40 per base

POWER & AV OPTIONS: [page 21- 38]

Non-powered round ABS plastic Grommet (black or silver) | List location code on page 18
 Non-powered rectangle metal Grommet (black or silver) | List location code on page 18

G (B/S) \$20 per grommet
 GV (B/S) \$120 per grommet

WIRE MANAGEMENT: [page 40 - 42]

Vertical plastic leg way for table base (black) or (silver)
 Vertical laser cut holes in table base (stationary tables only)
 Horizontal plastic 4-channel raceway
 Horizontal conference raceway
 Horizontal J-channel that hangs off perforated metal modesty panel

WR-B/S \$25 per base
 WB \$50 per base
 WH \$80 per table
 WT \$475 per table
 MMJ \$210 per table

MODESTY PANELS: 9" High straight panels [page 39]

Laminate (Model Code: ML)	Metal (Model Code: MM)
30" panel \$210 list price	30" panel \$185 list price
36" panel \$230 list price	36" panel \$190 list price
42" panel \$240 list price	42" panel \$225 list price
48" panel \$250 list price	48" panel \$230 list price
60" panel \$270 list price	60" panel \$245 list price
72" panel \$300 list price	72" panel \$265 list price



How to Order:

Email orders to: sales@hi5furniture.com

1. Choose your base model
2. Add edge code to base model
3. Choose finishes
4. Select options to add to table
5. Select finishes of options

Height Adjustment Ranges:

Pneumatic 27.25" - 45"
 Hand crank 27.25" - 36.75"
 Electric 2 stage 27.75" - 46.75"
 Electric 3 stage 22.25" - 44.25"

Laminate & FormaWrap Tables

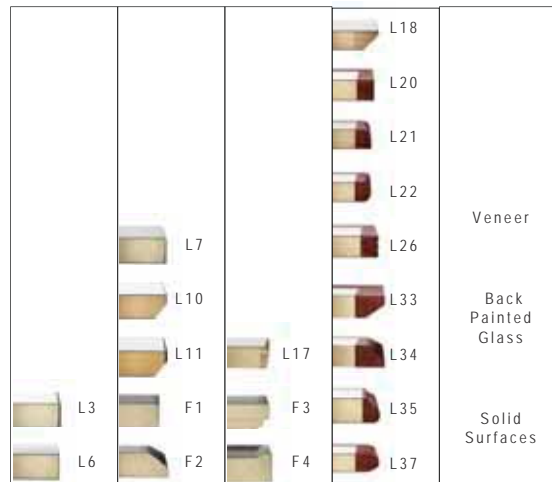

Table Size	Top Shape	Table Function	Model Code:	Top QTY	Base QTY	Base Spread	Base Style						
24" x 48"	rectangle	Stationary	EEC1 1248RE S	1	2	18"	C	1120	1180	1375	1595	Contact	Factory
24" x 48"	rectangle	Stationary	EET1 2448RE S	1	2	18"	T	1120	1180	1375	1595	Contact	Factory
24" x 48"	rectangle	Pneumatic	EEC1 2448RE P	1	2	18"	C	3605	3665	3860	4080	Contact	Factory
24" x 48"	rectangle	Pneumatic	EET1 2448RE P	1	2	18"	T	3605	3665	3860	4080	Contact	Factory
24" x 48"	rectangle	Hand crank	EEC1 2448RE H	1	2	18"	C	1980	2040	2235	2455	Contact	Factory
24" x 48"	rectangle	Hand crank	EET1 2448RE H	1	2	18"	T	1980	2040	2235	2455	Contact	Factory
24" x 48"	rectangle	Electric 2 stage	EEC1 2448RE E2	1	2	18"	C	3475	3535	3730	3950	Contact	Factory
24" x 48"	rectangle	Electric 2 stage	EET1 2448RE E2	1	2	18"	T	3475	3535	3730	3950	Contact	Factory
24" x 48"	rectangle	Electric 3 stage	EEC1 2448RE E3	1	2	18"	C	4100	4160	4355	4575	Contact	Factory
24" x 48"	rectangle	Electric 3 stage	EET1 2448RE E3	1	2	18"	T	4100	4160	4355	4575	Contact	Factory
24" x 60"	rectangle	Stationary	EEC1 2460RE S	1	2	18"	C	1190	1255	1520	1790	Contact	Factory
24" x 60"	rectangle	Stationary	EET1 2460RE S	1	2	18"	T	1190	1255	1520	1790	Contact	Factory
24" x 60"	rectangle	Pneumatic	EEC1 2460RE P	1	2	18"	C	3675	3740	4005	4275	Contact	Factory
24" x 60"	rectangle	Pneumatic	EET1 2460RE P	1	2	18"	T	3675	3740	4005	4275	Contact	Factory
24" x 60"	rectangle	Hand crank	EEC1 2460RE H	1	2	18"	C	2050	2115	2380	2650	Contact	Factory
24" x 60"	rectangle	Hand crank	EET1 2460RE H	1	2	18"	T	2050	2115	2380	2650	Contact	Factory
24" x 60"	rectangle	Electric 2 stage	EEC1 2460RE E2	1	2	18"	C	3445	3610	3875	4145	Contact	Factory
24" x 60"	rectangle	Electric 2 stage	EET1 2460RE E2	1	2	18"	T	3445	3610	3875	4145	Contact	Factory
24" x 60"	rectangle	Electric 3 stage	EEC1 2460RE E3	1	2	18"	C	4170	4235	4500	4770	Contact	Factory
24" x 60"	rectangle	Electric 3 stage	EET1 2460RE E3	1	2	18"	T	4170	4235	4500	4770	Contact	Factory
24" x 72"	rectangle	Stationary	EEC1 2472RE S	1	2	18"	C	2150	1330	1665	2000	Contact	Factory
24" x 72"	rectangle	Stationary	EET1 2472RE S	1	2	18"	T	2150	1330	1665	2000	Contact	Factory
24" x 72"	rectangle	Pneumatic	EEC1 2472RE P	1	2	18"	C	3725	3815	4150	4485	Contact	Factory
24" x 72"	rectangle	Pneumatic	EET1 2472RE P	1	2	18"	T	3725	3815	4150	4485	Contact	Factory
24" x 72"	rectangle	Hand crank	EEC1 2472RE H	1	2	18"	C	2110	2190	2525	2860	Contact	Factory
24" x 72"	rectangle	Hand crank	EET1 2472RE H	1	2	18"	T	2110	2190	2525	2860	Contact	Factory
24" x 72"	rectangle	Electric 2 stage	EEC1 2472RE E2	1	2	18"	C	3605	3685	4020	4355	Contact	Factory
24" x 72"	rectangle	Electric 2 stage	EET1 2472RE E2	1	2	18"	T	3605	3685	4020	4355	Contact	Factory
24" x 72"	rectangle	Electric 3 stage	EEC1 2472RE E3	1	2	18"	C	4230	4310	4645	4980	Contact	Factory
24" x 72"	rectangle	Electric 3 stage	EET1 2472RE E3	1	2	18"	T	4230	4310	4645	4980	Contact	Factory

BASE OPTIONS: [page 45 for base heights]

Locking casters for carpet – T Bases

MODEL CODE

CS \$40 per base

POWER & AV OPTIONS: [page 21-38]

Non-powered round ABS plastic Grommet (black or silver) | List location code on page 18
 Non-powered rectangle metal Grommet (black or silver) | List location code on page 18

G (B/S) \$20 per grommet
 GV (B/S) \$120 per grommet

WIRE MANAGEMENT: [page 40 - 42]

Vertical plastic leg way for table base (black) or (silver)
 Vertical laser cut holes in table base (stationary tables only)
 Horizontal plastic 4-channel raceway
 Horizontal conference raceway
 Horizontal J-channel that hangs off perforated metal modesty panel

WR-B/S \$25 per base
 WB \$50 per base
 WH \$80 per table
 WT \$475 per table
 MMJ \$210 per table

MODESTY PANELS: 9" High straight panels [page 39]

Laminate (Model Code: ML)	Metal (Model Code: MM)
30" panel \$210 list price	30" panel \$185 list price
36" panel \$230 list price	36" panel \$190 list price
42" panel \$240 list price	42" panel \$225 list price
48" panel \$250 list price	48" panel \$230 list price
60" panel \$270 list price	60" panel \$245 list price
72" panel \$300 list price	72" panel \$265 list price



How to Order:

Email orders to: sales@hi5furniture.com

1. Choose your base model
2. Add edge code to base model
3. Choose finishes
4. Select options to add to table
5. Select finishes of options

Height Adjustment Ranges:

- Pneumatic 27.25" - 45"
- Hand crank 27.25" - 36.75"
- Electric 2 stage 27.75" - 46.75"
- Electric 3 stage 22.25" - 44.25"

Laminate & FormaWrap Tables

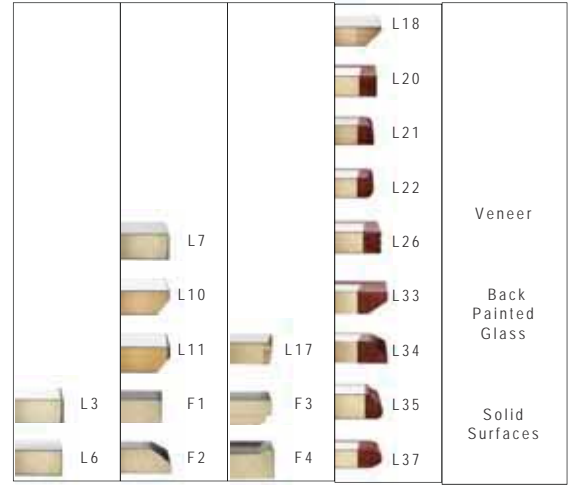

Table Size	Top Shape	Table Function	Model Code:	Top QTY	Base QTY	Base Spread	Base Style					
30" x 48"	rectangle	Stationary	EEC1 3048RE S	1	2	22"	C	1210	1275	1530	1820	Contact Factory
30" x 48"	rectangle	Stationary	EET1 3048RE S	1	2	22"	T	1210	1275	1530	1820	Contact Factory
30" x 48"	rectangle	Pneumatic	EEC1 3048RE P	1	2	22"	C	3690	3755	4010	4300	Contact Factory
30" x 48"	rectangle	Pneumatic	EET1 3048RE P	1	2	22"	T	3690	3755	4010	4300	Contact Factory
30" x 48"	rectangle	Hand crank	EEC1 3048RE H	1	2	22"	C	2065	2130	2385	2675	Contact Factory
30" x 48"	rectangle	Hand crank	EET1 3048RE H	1	2	22"	T	2065	2130	2385	2675	Contact Factory
30" x 48"	rectangle	Electric 2 stage	EEC1 3048RE E2	1	2	22"	C	3555	3620	3875	4165	Contact Factory
30" x 48"	rectangle	Electric 2 stage	EET1 3048RE E2	1	2	22"	T	3555	3620	3875	4165	Contact Factory
30" x 48"	rectangle	Electric 3 stage	EEC1 3048RE E3	1	2	22"	C	4190	4255	4510	4800	Contact Factory
30" x 48"	rectangle	Electric 3 stage	EET1 3048RE E3	1	2	22"	T	4190	4255	4510	4800	Contact Factory
30" x 60"	rectangle	Stationary	EEC1 3060RE S	1	2	22"	C	1290	1365	1705	2070	Contact Factory
30" x 60"	rectangle	Stationary	EET1 3060RE S	1	2	22"	T	1290	1365	1705	2070	Contact Factory
30" x 60"	rectangle	Pneumatic	EEC1 3060RE P	1	2	22"	C	3770	3845	4185	4550	Contact Factory
30" x 60"	rectangle	Pneumatic	EET1 3060RE P	1	2	22"	T	3770	3845	4185	4550	Contact Factory
30" x 60"	rectangle	Hand crank	EEC1 3060RE H	1	2	22"	C	2145	2220	2560	2925	Contact Factory
30" x 60"	rectangle	Hand crank	EET1 3060RE H	1	2	22"	T	2145	2220	2560	2925	Contact Factory
30" x 60"	rectangle	Electric 2 stage	EEC1 3060RE E2	1	2	22"	C	3635	3710	4050	4415	Contact Factory
30" x 60"	rectangle	Electric 2 stage	EET1 3060RE E2	1	2	22"	T	3635	3710	4050	4415	Contact Factory
30" x 60"	rectangle	Electric 3 stage	EEC1 3060RE E3	1	2	22"	C	4270	4345	4685	5050	Contact Factory
30" x 60"	rectangle	Electric 3 stage	EET1 3060RE E3	1	2	22"	T	4270	4345	4685	5050	Contact Factory
30" x 72"	rectangle	Stationary	EEC1 3072RE S	1	2	22"	C	1370	1455	1880	2330	Contact Factory
30" x 72"	rectangle	Stationary	EET1 3072RE S	1	2	22"	T	1370	1455	1880	2330	Contact Factory
30" x 72"	rectangle	Pneumatic	EEC1 3072RE P	1	2	22"	C	3850	3935	4360	4810	Contact Factory
30" x 72"	rectangle	Pneumatic	EET1 3072RE P	1	2	22"	T	3850	3935	4360	4810	Contact Factory
30" x 72"	rectangle	Hand crank	EEC1 3072RE H	1	2	22"	C	2225	2310	2735	3185	Contact Factory
30" x 72"	rectangle	Hand crank	EET1 3072RE H	1	2	22"	T	2225	2310	2735	3185	Contact Factory
30" x 72"	rectangle	Electric 2 stage	EEC1 3072RE E2	1	2	22"	C	3715	3800	4225	4675	Contact Factory
30" x 72"	rectangle	Electric 2 stage	EET1 3072RE E2	1	2	22"	T	3715	3800	4225	4675	Contact Factory
30" x 72"	rectangle	Electric 3 stage	EEC1 3072RE E3	1	2	22"	C	4350	4435	4860	5310	Contact Factory
30" x 72"	rectangle	Electric 3 stage	EET1 3072RE E3	1	2	22"	T	4350	4435	4860	5310	Contact Factory

BASE OPTIONS: [page 45 for base heights]

Locking casters for carpet - T Bases

MODEL CODE

CS

LIST PRICE

\$40 per base

POWER & A/V OPTIONS: [page 21-38]

Non-powered round ABS plastic Grommet (black or silver) | List location code on page 18

G (B/S)

\$20 per grommet

Non-powered rectangle metal Grommet (black or silver) | List location code on page 18

GV (B/S)

\$120 per grommet

WIRE MANAGEMENT: [page 40 - 42]

Vertical plastic leg way for table base (black) or (silver)

WR-B/S

\$25 per base

Vertical laser cut holes in table base (stationary tables only)

WB

\$50 per base

Horizontal plastic 4-channel raceway

WH

\$80 per table

Horizontal conference raceway

WT

\$475 per table

Horizontal J-channel that hangs off perforated metal modesty panel

MMJ

\$210 per table

MODESTY PANELS: 9" High straight panels [page 39]

Laminate (Model Code: ML)

Metal (Model Code: MM)

30" panel \$210 list price

30" panel \$185 list price

36" panel \$230 list price

36" panel \$190 list price

42" panel \$240 list price

42" panel \$225 list price

48" panel \$250 list price

48" panel \$230 list price

60" panel \$270 list price

60" panel \$245 list price

72" panel \$300 list price

72" panel \$265 list price



How to Order:

Email orders to: sales@hi5furniture.com

1. Choose your base model
2. Add edge code to base model
3. Choose finishes
4. Select options to add to table
5. Select finishes of options

Height Adjustment Ranges:

- Pneumatic 27.25" - 45"
- Hand crank 27.25" - 36.75"
- Electric 2 stage 27.75" - 46.75"
- Electric 3 stage 22.25" - 44.25"

Table Size	Top Shape	Table Function	Model Code:	Top QTY	Base QTY	Base Spread	Base Style
36" x 48"	rectangle	Stationary	EEC1 3648RE S	1	2	26"	C
36" x 48"	rectangle	Stationary	EET1 3648RE S	1	2	26"	T
36" x 48"	rectangle	Pneumatic	EEC1 3648RE P	1	2	26"	C
36" x 48"	rectangle	Pneumatic	EET1 3648RE P	1	2	26"	T
36" x 48"	rectangle	Hand crank	EEC1 3648RE H	1	2	26"	C
36" x 48"	rectangle	Hand crank	EET1 3648RE H	1	2	26"	T
36" x 48"	rectangle	Electric 2 stage	EEC1 3648RE E2	1	2	26"	C
36" x 48"	rectangle	Electric 2 stage	EET1 3648RE E2	1	2	26"	T
36" x 48"	rectangle	Electric 3 stage	EEC1 3648RE E3	1	2	26"	C
36" x 48"	rectangle	Electric 3 stage	EET1 3648RE E3	1	2	26"	T
36" x 60"	rectangle	Stationary	EEC1 3660RE S	1	2	26"	C
36" x 60"	rectangle	Stationary	EET1 3660RE S	1	2	26"	T
36" x 60"	rectangle	Pneumatic	EEC1 3660RE P	1	2	26"	C
36" x 60"	rectangle	Pneumatic	EET1 3660RE P	1	2	26"	T
36" x 60"	rectangle	Hand crank	EEC1 3660RE H	1	2	26"	C
36" x 60"	rectangle	Hand crank	EET1 3660RE H	1	2	26"	T
36" x 60"	rectangle	Electric 2 stage	EEC1 3660RE E2	1	2	26"	C
36" x 60"	rectangle	Electric 2 stage	EET1 3660RE E2	1	2	26"	T
36" x 60"	rectangle	Electric 3 stage	EEC1 3660RE E3	1	2	26"	C
36" x 60"	rectangle	Electric 3 stage	EET1 3660RE E3	1	2	26"	T
36" x 72"	rectangle	Stationary	EEC1 3672RE S	1	2	26"	C
36" x 72"	rectangle	Stationary	EET1 3672RE S	1	2	26"	T
36" x 72"	rectangle	Pneumatic	EEC1 3672RE P	1	2	26"	C
36" x 72"	rectangle	Pneumatic	EET1 3672RE P	1	2	26"	T
36" x 72"	rectangle	Hand crank	EEC1 3672RE H	1	2	26"	C
36" x 72"	rectangle	Hand crank	EET1 3672RE H	1	2	26"	T
36" x 72"	rectangle	Electric 2 stage	EEC1 3672RE E2	1	2	26"	C
36" x 72"	rectangle	Electric 2 stage	EET1 3672RE E2	1	2	26"	T
36" x 72"	rectangle	Electric 3 stage	EEC1 3672RE E3	1	2	26"	C
36" x 72"	rectangle	Electric 3 stage	EET1 3672RE E3	1	2	26"	T

Laminate & FormaWrap Tables



Table Size	Top Shape	Table Function	Model Code:	Top QTY	Base QTY	Base Spread	Base Style	Price 1	Price 2	Price 3	Price 4	Finish
36" x 48"	rectangle	Stationary	EEC1 3648RE S	1	2	26"	C	1305	1375	1690	2040	Contact Factory
36" x 48"	rectangle	Stationary	EET1 3648RE S	1	2	26"	T	1305	1375	1690	2040	Contact Factory
36" x 48"	rectangle	Pneumatic	EEC1 3648RE P	1	2	26"	C	3790	3860	4175	4525	Contact Factory
36" x 48"	rectangle	Pneumatic	EET1 3648RE P	1	2	26"	T	3790	3860	4175	4525	Contact Factory
36" x 48"	rectangle	Hand crank	EEC1 3648RE H	1	2	26"	C	2160	2230	2545	2895	Contact Factory
36" x 48"	rectangle	Hand crank	EET1 3648RE H	1	2	26"	T	2160	2230	2545	2895	Contact Factory
36" x 48"	rectangle	Electric 2 stage	EEC1 3648RE E2	1	2	26"	C	3660	3730	4045	4395	Contact Factory
36" x 48"	rectangle	Electric 2 stage	EET1 3648RE E2	1	2	26"	T	3660	3730	4045	4395	Contact Factory
36" x 48"	rectangle	Electric 3 stage	EEC1 3648RE E3	1	2	26"	C	4285	4355	4670	5020	Contact Factory
36" x 48"	rectangle	Electric 3 stage	EET1 3648RE E3	1	2	26"	T	4285	4355	4670	5020	Contact Factory
36" x 60"	rectangle	Stationary	EEC1 3660RE S	1	2	26"	C	1400	1480	1900	2335	Contact Factory
36" x 60"	rectangle	Stationary	EET1 3660RE S	1	2	26"	T	1400	1480	1900	2335	Contact Factory
36" x 60"	rectangle	Pneumatic	EEC1 3660RE P	1	2	26"	C	3885	3965	4385	4820	Contact Factory
36" x 60"	rectangle	Pneumatic	EET1 3660RE P	1	2	26"	T	3885	3965	4385	4820	Contact Factory
36" x 60"	rectangle	Hand crank	EEC1 3660RE H	1	2	26"	C	2255	2335	2755	3190	Contact Factory
36" x 60"	rectangle	Hand crank	EET1 3660RE H	1	2	26"	T	2255	2335	2755	3190	Contact Factory
36" x 60"	rectangle	Electric 2 stage	EEC1 3660RE E2	1	2	26"	C	3755	3835	4255	4690	Contact Factory
36" x 60"	rectangle	Electric 2 stage	EET1 3660RE E2	1	2	26"	T	3755	3835	4255	4690	Contact Factory
36" x 60"	rectangle	Electric 3 stage	EEC1 3660RE E3	1	2	26"	C	4380	4460	4880	5315	Contact Factory
36" x 60"	rectangle	Electric 3 stage	EET1 3660RE E3	1	2	26"	T	4380	4460	4880	5315	Contact Factory
36" x 72"	rectangle	Stationary	EEC1 3672RE S	1	2	26"	C	1490	1585	2110	2645	Contact Factory
36" x 72"	rectangle	Stationary	EET1 3672RE S	1	2	26"	T	1490	1585	2110	2645	Contact Factory
36" x 72"	rectangle	Pneumatic	EEC1 3672RE P	1	2	26"	C	3975	4070	4595	5130	Contact Factory
36" x 72"	rectangle	Pneumatic	EET1 3672RE P	1	2	26"	T	3975	4070	4595	5130	Contact Factory
36" x 72"	rectangle	Hand crank	EEC1 3672RE H	1	2	26"	C	2345	2440	2965	3500	Contact Factory
36" x 72"	rectangle	Hand crank	EET1 3672RE H	1	2	26"	T	2345	2440	2965	3500	Contact Factory
36" x 72"	rectangle	Electric 2 stage	EEC1 3672RE E2	1	2	26"	C	3845	3940	4465	5000	Contact Factory
36" x 72"	rectangle	Electric 2 stage	EET1 3672RE E2	1	2	26"	T	3845	3940	4465	5000	Contact Factory
36" x 72"	rectangle	Electric 3 stage	EEC1 3672RE E3	1	2	26"	C	4470	4565	5090	5625	Contact Factory
36" x 72"	rectangle	Electric 3 stage	EET1 3672RE E3	1	2	26"	T	4470	4565	5090	5625	Contact Factory

BASE OPTIONS: [page 45 for base heights]

Locking casters for carpet - T Bases

MODEL CODE

CS

LIST PRICE

\$40 per base

POWER & AV OPTIONS: [page 21- 38]

Non-powered round ABS plastic Grommet (black or silver) | List location code on page 18

G (B/S)

\$20 per grommet

Non-powered rectangle metal Grommet (black or silver) | List location code on page 18

GV (B/S)

\$120 per grommet

WIRE MANAGEMENT: [page 40 - 42]

Vertical plastic leg way for table base (black) or (silver)

WR-B/S

\$25 per base

Vertical laser cut holes in table base (stationary tables only)

WB

\$50 per base

Horizontal plastic 4-channel raceway

WH

\$80 per table

Horizontal conference raceway

WT

\$475 per table

Horizontal J-channel that hangs off perforated metal modesty panel

MMJ

\$210 per table

MODESTY PANELS: 9" High straight panels [page 39]

Laminate (Model Code: ML)

Metal (Model Code: MM)

30" panel \$210 list price

30" panel \$185 list price

36" panel \$230 list price

36" panel \$190 list price

42" panel \$240 list price

42" panel \$225 list price

48" panel \$250 list price

48" panel \$230 list price

60" panel \$270 list price

60" panel \$245 list price

72" panel \$300 list price

72" panel \$265 list price



How to Order:

Email orders to: sales@hi5furniture.com

1. Choose your base model
2. Add edge code to base model
3. Choose finishes
4. Select options to add to table
5. Select finishes of options

Height Adjustment Ranges:

Pneumatic 27.25" - 45"
 Hand crank 27.25" - 36.75"
 Electric 2 stage 27.75" - 46.75"
 Electric 3 stage 22.25" - 44.25"

Laminate Tables

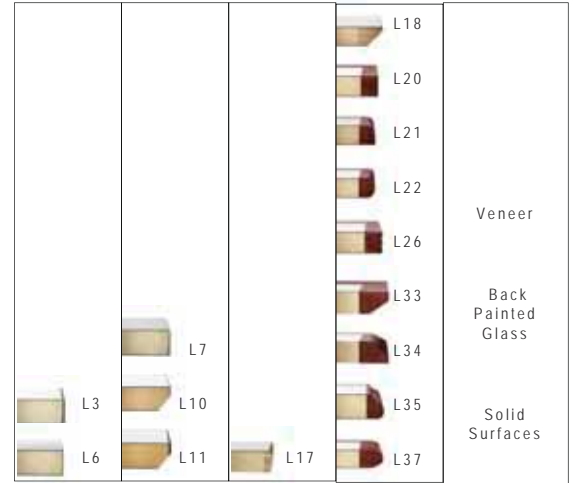

Table Size	Top Shape	Table Function	Model Code:	Top QTY	Base QTY	Base Spread	Base Style					
48" x 60"	rectangle	Stationary	EET2 4860RE S	1	2	36"	TT	2240	2325	3120	3690	Contact Factory
48" x 60"	rectangle	Electric 2 stage	EET2 4860RE E2	1	2	36"	TT	3815	3900	4695	5265	Contact Factory
48" x 60"	rectangle	Electric 3 stage	EET2 4860RE E3	1	2	36"	TT	4545	4630	5425	5995	Contact Factory
60" x 60"	square	Stationary	EET2 6060SQ S	1	2	36"	TT	2310	2410	3475	4200	Contact Factory
60" x 60"	square	Electric 2 stage	EET2 6060SQ E2	1	2	36"	TT	3885	3985	5050	6125	Contact Factory
60" x 60"	square	Electric 3 stage	EET2 6060SQ E3	1	2	36"	TT	4615	4715	5780	6505	Contact Factory

BASE OPTIONS: [page 45 for base heights]

Locking casters for carpet – T Bases

MODEL CODE

CS

LIST PRICE

\$40 per base

POWER & A/V OPTIONS : [page 21-38]

Non-powered round ABS plastic Grommet (black or silver) | List location code on page 18

G (B/S)

\$20 per grommet

Non-powered rectangle metal Grommet (black or silver) | List location code on page 18

GV (B/S)

\$120 per grommet

WIRE MANAGEMENT: [page 40 - 42]

Vertical plastic leg way for table base (black) or (silver)

WR-B/S

\$25 per base

Vertical laser cut holes in table base (stationary tables only)

WB

\$50 per base

Horizontal plastic 4-channel raceway

WH

\$80 per table

Horizontal conference raceway

WT

\$475 per table

Horizontal J-channel that hangs off perforated metal modesty panel

MMJ

\$210 per table

MODESTY PANELS: 9" High straight panels [page 39]

Laminate (Model Code: ML)

Metal (Model Code: MM)

30" panel \$210 list price

30" panel \$185 list price

36" panel \$230 list price

36" panel \$190 list price

42" panel \$240 list price

42" panel \$225 list price

48" panel \$250 list price

48" panel \$230 list price

60" panel \$270 list price

60" panel \$245 list price

72" panel \$300 list price

72" panel \$265 list price

Gateway Options

Below are options that are available on all Gateway tables.



BASE OPTIONS: [page 45 for base heights]

- Add 3rd base for training on 84" and 96" tables
- Bar Height table (overall table height is 41.5")
- Café Height tables (overall table height is 36")
- Alternate table height shorter than 29"
- Alternate table height taller than 29"
- Adjustable height (spring clip) T-Base only 26" – 35"
- Locking Casters (T Bases - Locking Casters are standard on nesting tables)
- Locking Casters (X Bases - Locking Casters are standard on nesting tables)
- Polished Chrome (C & T Bases)
- Polished Chrome (X Bases)
- Polished Chrome (TT Bases)

TABLE OPTIONS:

- Custom Stain for wood edges and veneers
- Premium Laminate
- Premium Edge-banding

POWER & A/V OPTIONS : [page 21- 38]

- Non-powered round ABS plastic Grommet (black or silver) | List location code on page 18
- Non-powered rectangle metal Grommet (black or silver) | List location code on page 18

WIRE MANAGEMENT: [page 40 - 42]

- Customer specified hole cut into top
- Vertical ABS Leg Way for table base (black or silver)
- 36" long Horizontal 4 track Extruded Raceway
- 12" wide x 34" wide Horizontal Conference Trough
- J-channel that attaches to Metal Modesty Panel

ACCESSORIES: [pages 39 - 49 for options]

- Table Gangers (per set) (N/A on wood edge tops)
- Fixed CPU holder width adjustment 2.75" x 5.25"
- Fixed CPU holder width adjustment 5.5" x 9.25"
- Swivel CPU holder width adjustment 2.75" x 5.25"
- Swivel CPU holder width adjustment 5.5" x 9.25"

MODESTY PANELS: 9" High straight panels [page 39]

Laminate (Model Code: ML)		Metal (Model Code: MM)	
30" panel	\$210 list price	30" panel	\$185 list price
36" panel	\$230 list price	36" panel	\$190 list price
42" panel	\$240 list price	42" panel	\$225 list price
48" panel	\$250 list price	48" panel	\$230 list price
60" panel	\$270 list price	60" panel	\$245 list price
72" panel	\$300 list price	72" panel	\$265 list price

MODEL CODE

ABGY	\$215 per base
BH	\$130 per base
CH	\$130 per base
SC	\$90 per base
TC	\$130 per base
AH	\$280 per base
CS	\$40 per base
CS	\$80 per base
CRT	\$160 per base
CRX	\$170 per base
CRTT	\$225 per base

UCS	\$600 per color
UCL	contact factory
UCE	contact factory

G (B/S)	\$20 per grommet
GV (B/S)	\$120 per grommet

CNC	\$250 set up fee per template
WV (B/S)	\$25 per piece
HW	\$80 per piece
WT	\$475 per Tray
WJ	\$210 per table

TG	\$135 per set
C1	\$160 per holder
C2	\$160 per holder
C3	\$260 per holder
C4	\$260 per holder

CONTACT FACTORY FOR LAYOUT, SIZE OPTIONS AND SPECIFICATION ASSISTANCE

Example Base Product Code :						Finish Selections:				
GY	T1	3060	RE	S	L3	-	Options in	BK	7909-60	BK
Product	Base	Top	Top	Table	Top		Alphabetical Order	Base	Top Laminate or	Edge
Line	style	size	shape	function	edge			Finish	Veneer Selection	Color

Laminate & FormaWrap Tables



- How to Order:**
 Email orders to: sales@hi5furniture.com
 1. Choose your base model
 2. Add edge code to base model
 3. Choose finishes
 4. Select options to add to table
 5. Select finishes of options

NOTE: Nesting tables come standard on locking casters.
 The Beam nesting system is used for 84" long and 96" long tables

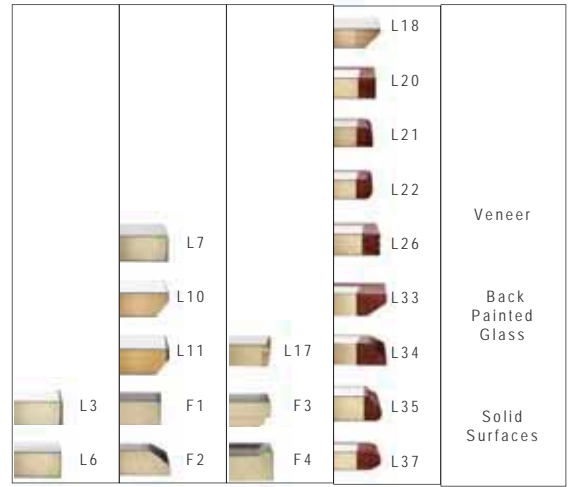

TRAPEZOID

Table Size	Top Shape	Table Function	Model Code:	Base QTY	Base Spread	Base Style		
24 x 60	trapezoid	stationary	GYT1 2460TZ S	2	16"	T	770	Contact Factory for all other edges
24 x 60	trapezoid	nesting	GYT1 2460TZ N	2	16"	T	1230	Contact Factory for all other edges
24 x 72	trapezoid	stationary	GYT1 2472TZ S	2	16"	T	910	Contact Factory for all other edges
24 x 72	trapezoid	nesting	GYT1 2472TZ N	2	16"	T	1365	Contact Factory for all other edges
30 x 60	trapezoid	stationary	GYT1 3060TZ S	2	22"	T	870	Contact Factory for all other edges
30 x 60	trapezoid	nesting	GYT1 3060TZ N	2	22"	T	1330	Contact Factory for all other edges
30 x 72	trapezoid	stationary	GYT1 3072TZ S	2	22"	T	1030	Contact Factory for all other edges
30 x 72	trapezoid	nesting	GYT1 3072TZ N	2	22"	T	1485	Contact Factory for all other edges



HALF ROUND

24 x 48	half round	stationary	GYT1 2448HR S	2	16"	T	740	Contact Factory for all other edges
24 x 48	half round	nesting	GYT1 2448HR N	2	16"	T	1195	Contact Factory for all other edges
30 x 60	half round	stationary	GYT1 3060HR S	2	22"	T	860	Contact Factory for all other edges
30 x 60	half round	nesting	GYT1 3060HR N	2	22"	T	1315	Contact Factory for all other edges
36 x 72	half round	stationary	GYT1 3672HR S	2	26"	T	1030	Contact Factory for all other edges
36 x 72	half round	nesting	GYT1 3672HR N	2	26"	T	1485	Contact Factory for all other edges



CRESCENT

24 x 48	crescent	stationary	GYT1 2448CR S	2	22"	T	1115	Contact Factory for all other edges
24 x 48	crescent	nesting	GYT1 2448CR N	2	22"	T	1570	Contact Factory for all other edges
30 x 60	crescent	stationary	GYT1 3060CR S	2	26"	T	1445	Contact Factory for all other edges
30 x 60	crescent	nesting	GYT1 3060CR N	2	26"	T	1900	Contact Factory for all other edges
36 x 72	crescent	stationary	GYT1 3672CR S	2	26"	T	1685	Contact Factory for all other edges

BASE OPTIONS: [page 45 for base heights]

- Bar Height table (overall table height is 41.5")
- Café Height tables (overall table height is 36")
- Adjustable height (spring clip) T-Base only
- Locking Casters (T Bases - Locking Casters are standard on nesting tables)
- Polished Chrome (C & T Bases Only)

MODEL CODE LIST PRICE

- BH \$130 per base
- CH \$130 per base
- AH \$280 per base
- CS \$40 per table
- CR \$160 per table

POWER & A/V OPTIONS: [page 21- 38]

- Non-powered round ABS plastic Grommet (black or silver) | List location code on page 18 G (B/S) \$20 per grommet
- Non-powered rectangle metal Grommet (black or silver) | List location code on page 18 GV (B/S) \$120 per grommet

WIRE MANAGEMENT: [page 40 - 42]

- Customer specified hole cut into top CNC \$250 set up fee per template
- Vertical ABS Leg Way for table base (black or silver) WV (B/S) \$25 per piece
- 36" long Horizontal 4 track Extruded Raceway HW \$80 per piece
- J-channel that attaches to Metal Modesty Panel WJ \$210 per table

ACCESSORIES: [pages 39 - 49 for options]

- Table Gangers (per set) (N/A on wood edge tops) TG \$135 per set

MODESTY PANELS: 9" High straight panels [page 39]

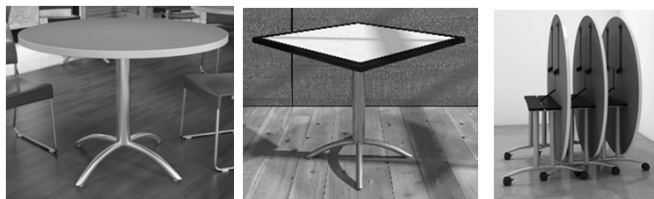

TT Nesting System

How to Order:

Email orders to: sales@hi5furniture.com

1. Choose your base model
2. Add edge code to base model
3. Choose finishes
4. Select options to add to table
5. Select finishes of options



NOTE: Nesting tables come standard on locking casters.
The Beam nesting system is used for 84" long and 96" long tables

Laminate & FormaWrap Tables

				L18	Veneer
				L20	
				L21	
				L22	Back Painted Glass
		L7		L26	
		L10		L33	
		L11	L17	L34	Solid Surfaces
L3	F1	F3		L35	
L6	F2	F4		L37	

Table Size	Top Shape	Table Function	Model Code:	Base QTY	Base Spread	Base Style					
30"	round	stationary	GYX1 30RD S	1	26"	X	745	900	1140	1255	Contact Factory
30"	round	nesting	GYX1 30RD N	1	26"	X	1020	1175	1445	1580	Contact Factory
36"	round	stationary	GYX1 36RD S	1	32"	X	910	1035	1355	1510	Contact Factory
36"	round	nesting	GYX1 36RD N	1	32"	X	1185	1310	1660	1835	Contact Factory
42"	round	stationary	GYX1 42RD S	1	32"	X	1065	1175	1565	1750	Contact Factory
42"	round	nesting	GYX1 42RD N	1	32"	X	1340	1410	1860	2075	Contact Factory
48"	round	stationary	GYX1 48RD S	1	38"	X	1090	1280	1760	2000	Contact Factory
48"	round	folding	GYT2 48RD F	2	36"	TT	2510	2620	3565	3750	Contact Factory
48"	round	beam nesting	GYT2 48RD BN	2	32"	TT	3280	3390	4335	4520	Contact Factory
60"	round	stationary	GYX4 60RD S	1	36"	X4	2350	2475	4070	4365	Contact Factory
60"	round	stationary	GYT2 60RD S	2	36"	TT	1640	1765	3360	3655	Contact Factory
60"	round	folding	GYT2 60RD F	2	36"	TT	2655	2780	4375	4670	Contact Factory
60"	round	beam nesting	GYT2 60RD BN	2	36"	TT	3780	3905	5500	5795	Contact Factory
30"	square	stationary	GYX1 30SQ S	1	26"	X	685	815"	1049	1165	Contact Factory
30"	square	nesting	GYX1 30SQ N	1	26"	X	960	1090"	1358	1490	Contact Factory
36"	square	stationary	GYX1 36SQ S	1	32"	X	840	960"	1265	1415	Contact Factory
36"	square	nesting	GYX1 36SQ N	1	32"	X	1115	1235"	1575	1740	Contact Factory
42"	square	stationary	GYX1 42SQ S	1	32"	X	890	1145	1535	1725	Contact Factory
42"	square	nesting	GYX1 42SQ N	1	32"	X	1165	1420	1840	2050	Contact Factory
48"	square	stationary	GYX1 48SQ S	1	38"	X	960	1200	1690	1935	Contact Factory
48"	square	folding	GYT2 48SQ F	2	36"	TT	2460	2535	3140	3605	Contact Factory
48"	square	beam nesting	GYT2 48SQ BN	2	32"	TT	3230	3305	3910	4375	Contact Factory
60"	square	stationary	GYX4 60SQ S	1	36"	X4	2290	2390	3455	4180	Contact Factory
60"	square	stationary	GYT2 60SQ S	2	36"	TT	1580	1680	2745	3820	Contact Factory
60"	square	folding	GYT2 60SQ F	2	36"	TT	2650	2750	3815	4540	Contact Factory

BASE OPTIONS: [page 45 for base heights]

- Bar Height table (overall table height is 41.5")
- Café Height tables (overall table height is 36")
- Alternate table height shorter than 29"
- Alternate table height taller than 29"
- Adjustable height (spring clip) T-Base only
- Locking Casters (T Bases - Locking Casters are standard on nesting tables)
- Locking Casters (X Bases - Locking Casters are standard on nesting tables)
- Polished Chrome (X Bases)

MODEL CODE LIST PRICE

- BH \$130 per base
- CH \$130 per base
- SC \$90 per base
- TC \$130 per base
- AH \$280 per base
- CS \$40 per table
- CS \$80 per table
- CR \$170 per table

TABLE OPTIONS:

- Custom Stain for wood edges and veneers
- Premium Laminate
- Premium Edge-banding
- UCS \$600 per color
- UCL Contact Factory
- UCE Contact Factory



T style base



Shown with Modesty Panel & Casters



Beam Nesting System

How to Order:

Email orders to: sales@hi5furniture.com

1. Choose your base model
2. Add edge code to base model
3. Choose finishes
4. Select options to add to table
5. Select finishes of options

NOTE: Nesting tables come standard on locking casters.
 The Beam nesting system is used for 84" long and 96" long tables

Table Size	Top Shape	Table Function	Model Code:	Base QTY	Base Spread	Base Style	Laminate & FormaWrap Tables				
24 x 48	rectangle	stationary	GYT1 2448RE S	2	22"	T	815	980	1280	1430	Contact Factory
24 x 48	rectangle	nesting	GYT1 2448RE N	2	22"	T	1315	1475	1845	2025	Contact Factory
24 x 60	rectangle	stationary	GYT1 2460RE S	2	22"	T	855	1045	1410	1590	Contact Factory
24 x 60	rectangle	folding	GYT1 2460RE F	2	22"	T	1180	1375	1780	1980	Contact Factory
24 x 60	rectangle	nesting	GYT1 2460RE N	2	22"	T	1355	1555	1975	2185	Contact Factory
24 x 72	rectangle	stationary	GYT1 2472RE S	2	22"	T	900	1130	1540	1745	Contact Factory
24 x 72	rectangle	folding	GYT1 2472RE F	2	22"	T	1225	1455	1905	2130	Contact Factory
24 x 72	rectangle	nesting	GYT1 2472RE N	2	22"	T	1400	1630	2100	2335	Contact Factory
24 x 84	rectangle	stationary	GYT1 2484RE S	2	22"	T	985	1200	1670	1900	Contact Factory
24 x 84	rectangle	folding	GYT1 2484RE F	2	22"	T	1315	1525	2035	2285	Contact Factory
24 x 84	rectangle	beam nesting	GYT1 2484RE BN	2	22"	T	2285	2365	2950	3385	Contact Factory
24 x 96	rectangle	stationary	GYT1 2496RE S	2	22"	T	1005	1280	1800	2055	Contact Factory
24 x 96	rectangle	folding	GYT1 2496RE F	2	22"	T	1330	1610	2165	2440	Contact Factory
24 x 96	rectangle	beam nesting	GYT1 2496RE BN	2	22"	T	2290	2385	2960	3395	Contact Factory

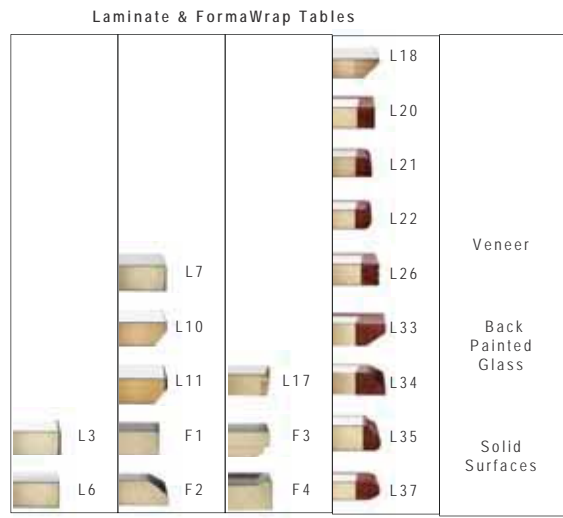

BASE OPTIONS: [page 45 for base heights]

- Add 3rd base for training on 84" and 96" tables
- Bar Height table (overall table height is 41.5")
- Café Height tables (overall table height is 36")
- Alternate table height shorter than 29"
- Alternate table height taller than 29"
- Adjustable height (spring clip) T-Base only
- Locking Casters (T Bases - Locking Casters are standard on nesting tables)
- Locking Casters (X Bases - Locking Casters are standard on nesting tables)
- Polished Chrome (C & T Bases Only)

MODEL CODE LIST PRICE

- ABGY \$215 per base
- BH \$130 per base
- CH \$130 per base
- SC \$90 per base
- TC \$130 per base
- AH \$280 per base
- CS \$40 per table
- CS \$80 per table
- CR \$160 per table

POWER & AVV OPTIONS: [page 21- 38]

- Non-powered round ABS plastic Grommet (black or silver) | List location code on page 18
- Non-powered rectangle metal Grommet (black or silver) | List location code on page 18

- G (B/S) \$20 per grommet
- GV (B/S) \$120 per grommet

WIRE MANAGEMENT: [page 40 - 42]

- Customer specified hole cut into top
- Vertical ABS Leg Way for table base (black or silver)
- 36" long Horizontal 4 track Extruded Raceway
- J-channel that attaches to Metal Modesty Panel

- CNC \$250 set up fee per template
- WV (B/S) \$25 per piece
- HW \$80 per piece
- WJ \$210 per table

ACCESSORIES: [pages 39 - 49 for options]

- Table Gangers (per set) (N/A on wood edge tops)
- Fixed CPU holder width adjustment 2.75" x 5.25"
- Fixed CPU holder width adjustment 5.5" x 9.25"

- TG \$135 per set
- C1 \$160 per holder
- C2 \$160 per holder

MODESTY PANELS: 9" High straight panels [page 39]

Laminate (Model Code: ML)		Metal (Model Code: MM)	
30" panel	\$210 list price	30" panel	\$185 list price
36" panel	\$230 list price	36" panel	\$190 list price
42" panel	\$240 list price	42" panel	\$225 list price
48" panel	\$250 list price	48" panel	\$230 list price
60" panel	\$270 list price	60" panel	\$245 list price
72" panel	\$300 list price	72" panel	\$265 list price

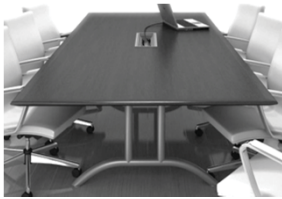

Beam Nesting System

How to Order:

Email orders to: sales@hi5furniture.com

1. Choose your base model
2. Add edge code to base model
3. Choose finishes
4. Select options to add to table
5. Select finishes of options

Racetrack or Boat Shaped Tables:

Replace the ? with an RT (for Racetrack) or a BT (for Boat) to complete the model code. [ex. CNCL 3660 BT - for a 36x60 boat]

NOTE: Nesting tables come standard on locking casters. The Beam nesting system is used for 84" long and 96" long tables

Laminate & FormaWrap Tables

				L18	
				L20	
				L21	
				L22	
				L26	Veneer
				L33	Back Painted Glass
				L34	
				L35	
				L37	Solid Surfaces
L7					
L10					
L11		L17			
L3	F1	F3			
L6	F2	F4			

Table Size	Top Shape	Table Function	Model Code:	Base QTY	Base Spread	Base Style						
30 x 48	rectangle	stationary	GYT1 3048RE S	2	26"	T	860	1060	1415	1590	Contact Factory	
30 x 48	rectangle	stationary	GYT1 3048RE F	2	26"	T	1310	1375	1360	1920	Contact Factory	
30 x 48	rectangle	nesting	GYT1 3048RE N	2	26"	T	1365	1560	1980	2185	Contact Factory	
30 x 60	rectangle	stationary	GYT1 3060RE S	2	26"	T	910	1145	1575	1785	Contact Factory	
30 x 60	racetrack or boat	stationary	GYT1 3060?T S	2	26"	T	1035	1115*	1505*	1700	Contact Factory	
30 x 60	rectangle	folding	GYT1 3060RE F	2	26"	T	1235	1470	1935	2165	Contact Factory	
30 x 60	rectangle	nesting	GYT1 3060RE N	2	26"	T	1410	1645	2135	2375	Contact Factory	
30 x 72	rectangle	stationary	GYT1 3072RE S	2	26"	T	960	1245	1735	1980	Contact Factory	
30 x 72	racetrack or boat	stationary	GYT1 3072?T S	2	26"	T	1080	1195*	1650*	1875	Contact Factory	
30 x 72	rectangle	folding	GYT1 3072RE F	2	26"	T	1285	1570	2100	2360	Contact Factory	
30 x 72	rectangle	nesting	GYT1 3072RE N	2	26"	T	1460	1745	2295	2570	Contact Factory	
30 x 84	rectangle	stationary	GYT1 3084RE S	2	26"	T	1070	1335	1885	2160	Contact Factory	
30 x 84	racetrack or boat	stationary	GYT1 3084?T S	2	26"	T	1180	1280*	1795*	2050	Contact Factory	
30 x 84	rectangle	folding	GYT1 3084RE F	2	26"	T	1395	1665	2255	2550	Contact Factory	
30 x 84	rectangle	beam nesting	GYT1 3084RE BN	2	26"	T	2380	2470	3210	3795	Contact Factory	
30 x 96	rectangle	stationary	GYT1 3096RE S	2	26"	T	1080	1425	2045	2355	Contact Factory	
30 x 96	racetrack or boat	stationary	GYT1 3096?T S	2	26"	T	1190	1360*	1940*	2225	Contact Factory	
30 x 96	rectangle	folding	GYT1 3096RE F	2	26"	T	1405	1750	2410	2740	Contact Factory	
30 x 96	rectangle	beam nesting	GYT1 3096RE BN	2	26"	T	2390	2490	3215	3815	Contact Factory	

BASE OPTIONS: [page 45 for base heights]

- Add 3" base for training on 84" and 96" tables
- Bar Height table (overall table height is 41.5")
- Café Height tables (overall table height is 36")
- Adjustable height (spring clip) T-Base only
- Locking Casters (T Bases - Locking Casters are standard on nesting tables)
- Locking Casters (X Bases - Locking Casters are standard on nesting tables)
- Polished Chrome (C & T Bases Only)

MODEL CODE LIST PRICE

- ABGY \$215 per base
- BH \$130 per base
- CH \$130 per base
- AH \$280 per base
- CS \$40 per table
- CS \$80 per table
- CR \$160 per table

POWER & AV OPTIONS: [page 21- 38]

- Non-powered round ABS plastic Grommet (black or silver) | List location code on page 18
- Non-powered rectangle metal Grommet (black or silver) | List location code on page 18

- G (B/S) \$20 per grommet
- GV (B/S) \$120 per grommet

WIRE MANAGEMENT: [page 40 - 42]

- Customer specified hole cut into top
- Vertical ABS Leg Way for table base (black or silver)
- 36" long Horizontal 4 track Extruded Raceway
- J-channel that attaches to Metal Modesty Panel

- CNC \$250 set up fee per template
- WV (B/S) \$25 per piece
- HW \$80 per piece
- WJ \$210 per table

ACCESSORIES: [pages 39 - 49 for options]

- Table Gangers (per set) (N/A on wood edge tops)
- Fixed CPU holder width adjustment 2.75" x 5.25"
- Fixed CPU holder width adjustment 5.5" x 9.25"

- TG \$135 per set
- C1 \$160 per holder
- C2 \$160 per holder

MODESTY PANELS: 9" High straight panels [page 39]

Laminate (Model Code: ML)	Metal (Model Code: MM)
30" panel \$210 list price	30" panel \$185 list price
36" panel \$230 list price	36" panel \$190 list price
42" panel \$240 list price	42" panel \$225 list price
48" panel \$250 list price	48" panel \$230 list price
60" panel \$270 list price	60" panel \$245 list price
72" panel \$300 list price	72" panel \$265 list price



Racetrack Top



Boat Top



Beam Nesting System

How to Order:

Email orders to: sales@hi5furniture.com

1. Choose your base model
2. Add edge code to base model
3. Choose finishes
4. Select options to add to table
5. Select finishes of options

Racetrack or Boat Shaped Tables:

Replace the ? with an RT (for Racetrack) or a BT (for Boat) to complete the model code. [ex. CNCL 3660 BT - for a 36x60 boat]

NOTE: Nesting tables come standard on locking casters.

The Beam nesting system is used for 84" long and 96" long tables

Table Size	Top Shape	Table Function	Model Code:	Base QTY	Base Spread	Base Style
36 x 48	rectangle	stationary	GYT1 3648RE S	2	26"	T
36 x 48	rectangle	folding	GYT1 3648RE F	2	26"	T
36 x 48	rectangle	nesting	GYT1 3648RE N	2	26"	T
36 x 60	rectangle	stationary	GYT1 3660RE S	2	26"	T
36 x 60	racetrack or boat	stationary	GYT1 3660?T S	2	26"	T
36 x 60	rectangle	folding	GYT1 3660RE F	2	26"	T
36 x 60	rectangle	nesting	GYT1 3660RE N	2	26"	T
36 x 72	rectangle	stationary	GYT1 3672RE S	2	26"	T
36 x 72	racetrack or boat	stationary	GYT1 3672?T S	2	26"	T
36 x 72	rectangle	folding	GYT1 3672RE F	2	26"	T
36 x 72	rectangle	nesting	GYT1 3672RE N	2	26"	T
36 x 84	rectangle	stationary	GYT2 3684RE S	2	36"	TT
36 x 84	racetrack or boat	stationary	GYT2 3684?T S	2	36"	TT
36 x 84	rectangle	beam nesting	GYT2 3684RE BN	2	32"	TT
36 x 96	rectangle	stationary	GYT2 3696RE S	2	36"	TT
36 x 96	racetrack or boat	stationary	GYT2 3696?T S	2	36"	TT
36 x 96	rectangle	beam nesting	GYT2 3696RE BN	2	32"	TT

Laminate & FormaWrap Tables

Edge Code	Finish	Edge Code	Finish	Edge Code	Finish	Edge Code	Finish
L18	Light Wood	L20	Dark Wood	L21	Dark Wood	L22	Dark Wood
L26	Dark Wood	L33	Dark Wood	L34	Dark Wood	L35	Dark Wood
L37	Dark Wood	L7	Light Wood	L10	Light Wood	L11	Light Wood
L17	Light Wood	F1	Light Wood	F3	Light Wood	F4	Light Wood
L3	Light Wood	L6	Light Wood	F2	Light Wood		

Veneer
Back Painted Glass
Solid Surfaces

Table Size	Top Shape	Table Function	Model Code:	Base QTY	Base Spread	Base Style	Price 1	Price 2	Price 3	Price 4	Finish
36 x 48	rectangle	stationary	GYT1 3648RE S	2	26"	T	890	1025	1395	1580	Contact Factory
36 x 48	rectangle	folding	GYT1 3648RE F	2	26"	T	1385	1455	1770	2120	Contact Factory
36 x 48	rectangle	nesting	GYT1 3648RE N	2	26"	T	1470	1540	1855	2205	Contact Factory
36 x 60	rectangle	stationary	GYT1 3660RE S	2	26"	T	955	1125	1565	1785	Contact Factory
36 x 60	racetrack or boat	stationary	GYT1 3660?T S	2	26"	T	1175	1200*	1655*	1880	Contact Factory
36 x 60	rectangle	folding	GYT1 3660RE F	2	26"	T	1390	1470	1890	2325	Contact Factory
36 x 60	rectangle	nesting	GYT1 3660RE N	2	26"	T	2130	2210	2630	3065	Contact Factory
36 x 72	rectangle	stationary	GYT1 3672RE S	2	26"	T	1020	1225	1735	1990	Contact Factory
36 x 72	racetrack or boat	stationary	GYT1 3672?T S	2	26"	T	1240	1300*	1820*	2080	Contact Factory
36 x 72	rectangle	folding	GYT1 3672RE F	2	26"	T	1480	1575	2100	2635	Contact Factory
36 x 72	rectangle	nesting	GYT1 3672RE N	2	26"	T	2220	2315	2840	3375	Contact Factory
36 x 84	rectangle	stationary	GYT2 3684RE S	2	36"	TT	1535	1680	2310	2620	Contact Factory
36 x 84	racetrack or boat	stationary	GYT2 3684?T S	2	36"	TT	1755	1760*	2400*	2720	Contact Factory
36 x 84	rectangle	beam nesting	GYT2 3684RE BN	2	32"	TT	3580	3705	4400	5105	Contact Factory
36 x 96	rectangle	stationary	GYT2 3696RE S	2	36"	TT	1550	1780	2480	2830	Contact Factory
36 x 96	racetrack or boat	stationary	GYT2 3696?T S	2	36"	TT	1770	1860*	2570*	2920	Contact Factory
36 x 96	rectangle	beam nesting	GYT2 3696RE BN	2	32"	TT	3590	3720	4425	5130	Contact Factory

BASE OPTIONS: [page 45 for base heights]

- Add 3rd base for training on 84" and 96" tables
- Bar Height table (overall table height is 41.5")
- Café Height tables (overall table height is 36")
- Adjustable height (spring clip) T-Base only
- Locking Casters (T Bases - Locking Casters are standard on nesting tables)
- Locking Casters (X Bases - Locking Casters are standard on nesting tables)
- Polished Chrome (C & T Bases Only)

MODEL CODE LIST PRICE

- ABGY \$215 per base
- BH \$130 per base
- CH \$130 per base
- AH \$280 per base
- CS \$40 per table
- CS \$80 per table
- CR \$160 per table

POWER & AV OPTIONS: [page 21- 38]

- Non-powered round ABS plastic Grommet (black or silver) | List location code on page 18
- Non-powered rectangle metal Grommet (black or silver) | List location code on page 18

- G (B/S) \$20 per grommet
- GV (B/S) \$120 per grommet

WIRE MANAGEMENT: [page 40 - 42]

- Customer specified hole cut into top
- Vertical ABS Leg Way for table base (black or silver)
- 36" long Horizontal 4 track Extruded Raceway
- J-channel that attaches to Metal Modesty Panel

- CNC \$250 set up fee per template
- WV (B/S) \$25 per piece
- HW \$80 per piece
- WJ \$210 per table

ACCESSORIES: [pages 39 - 49 for options]

- Table Gangers (per set) (N/A on wood edge tops)
- Fixed CPU holder width adjustment 2.75" x 5.25"
- Fixed CPU holder width adjustment 5.5" x 9.25"

- TG \$135 per set
- C1 \$160 per holder
- C2 \$160 per holder

MODESTY PANELS: 9" High straight panels [page 39]

Laminate (Model Code: ML)	Metal (Model Code: MM)
30" panel \$210 list price	30" panel \$185 list price
36" panel \$230 list price	36" panel \$190 list price
42" panel \$240 list price	42" panel \$225 list price
48" panel \$250 list price	48" panel \$230 list price
60" panel \$270 list price	60" panel \$245 list price
72" panel \$300 list price	72" panel \$265 list price



How to Order:

- Email orders to: sales@hi5furniture.com
- 1. Choose your base model
- 2. Add edge code to base model
- 3. Choose finishes
- 4. Select options to add to table
- 5. Select finishes of options

Racetrack or Boat Shaped Tables:

Replace the ? with an RT (for Racetrack) or a BT (for Boat) to complete the model code. [ex. CNCL 3660 BT - for a 36x60 boat]

NOTE: Nesting tables come standard on locking casters.
 The Beam nesting system is used for 84" long and 96" long tables

Laminate Tables					
				L18	Veneer
				L20	
				L21	
				L22	
				L26	
				L33	
				L34	Back Painted Glass
				L35	
				L37	Solid Surfaces
L3	L7				
L6	L10	L11	L17		

Table Size	Top Shape	Table Function	Model Code:	Base QTY	Base Spread	Base Style					
48 x 60	rectangle	stationary	GYT2 4860RE S	2	36"	TT	1330	1640	2245	2545	Contact Factory
48 x 60	racetrack or boat	stationary	GYT2 4860?T S	2	36"	TT	1550	1725	2335	2635	Contact Factory
48 x 72	racetrack or boat	stationary	GYT2 4872?T S	2	36"	TT	1615	1850	2560	2910	Contact Factory
48 x 72	rectangle	stationary	GYT2 4872RE S	2	36"	TT	1395	1770	2470	2810	Contact Factory
48 x 84	rectangle	stationary	GYT2 4884RE S	2	36"	TT	1550	2610	3490	3920	Contact Factory
48 x 84	racetrack or boat	stationary	GYT2 4884?T S	2	36"	TT	1770	2690	3580	4020	Contact Factory
48 x 96	rectangle	stationary	GYT2 4896RE S	2	36"	TT	1560	2735	3705	4190	Contact Factory
48 x 96	racetrack or boat	stationary	GYT2 4896?T S	2	36"	TT	1780	2820	3800	4285	Contact Factory
48 x 120	rectangle	stationary	GYT2 48120RE S	3	36"	TT	2130	3425	4635	5235	Contact Factory
48 x 120	racetrack or boat	stationary	GYT2 48120?T S	3	36"	TT	2350	3500	4720	5325	Contact Factory
48 x 144	rectangle	stationary	GYT2 48144RE S	4	36"	TT	3015	4210	5670	6400	Contact Factory
48 x 144	racetrack or boat	stationary	GYT2 48144?T S	4	36"	TT	3825	4290	5760	6495	Contact Factory
48 x 168	rectangle	stationary	GYT2 48168RE S	4	36"	TT	3035	4630	6440	7335	Contact Factory
48 x 168	racetrack or boat	stationary	GYT2 48168?T S	4	36"	TT	3255	4700	6510	7405	Contact Factory
48 x 192	rectangle	stationary	GYT2 48192RE S	4	36"	TT	3055	4720	6560	7470	Contact Factory
48 x 192	racetrack or boat	stationary	GYT2 48192?T S	4	36"	TT	3275	4800	6640	7560	Contact Factory

BASE OPTIONS: [page 45 for base heights]

- Bar Height table (overall table height is 41.5")
- Café Height tables (overall table height is 36")
- Alternate table height shorter than 29"
- Alternate table height taller than 29"
- Adjustable height (spring clip) T-Base only
- Locking Casters (T Bases - Locking Casters are standard on nesting tables)

MODEL CODE

LIST PRICE

- BH \$130 per base
- CH \$130 per base
- SC \$90 per base
- TC \$130 per base
- AH \$280 per base
- CS \$40 per table

TABLE OPTIONS:

- Custom Stain for wood edges and veneers
- Premium Laminate
- Premium Edge-banding

- UCS \$600 per color
- UCL Contact Factory
- UCE Contact Factory

POWER & AV OPTIONS: [page 21 - 38]

- Non-powered round ABS plastic Grommet (black or silver) | List location code on page 18
- Non-powered rectangle metal Grommet (black or silver) | List location code on page 18

- G (B/S) \$20 per grommet
- GV (B/S) \$120 per grommet

WIRE MANAGEMENT: [page 40 - 42]

- Customer specified hole cut into top
- Vertical ABS Leg Way for table base (black or silver)
- 36" long Horizontal 4 track Extruded Raceway
- 12" wide x 34" wide Horizontal Conference Trough

- CNC \$250 set up fee per template
- WV (B/S) \$25 per piece
- HW \$80 per piece
- WT \$475 per Tray

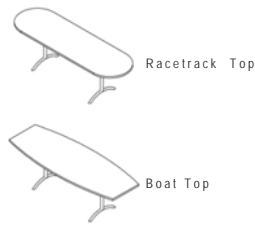

How to Order:

Email orders to: sales@hi5furniture.com

1. Choose your base model
2. Add edge code to base model
3. Choose finishes
4. Select options to add to table
5. Select finishes of options

Racetrack or Boat Shaped Tables:

Replace the ? with an RT (for Racetrack) or a BT (for Boat) to complete the model code. [ex. CNCL 3660 BT - for a 36x60 boat]

NOTE: Nesting tables come standard on locking casters.
The Beam nesting system is used for 84" long and 96" long tables

Table Size	Top Shape	Table Function	Table Model Code:	Base QTY	Base Spread	Base Style	Laminates				Finish											
60 x 72	rectangle	stationary	GYT2 6072RE S	2	36"	TT	L3	L6	L7	L10	L11	L17	L18	L20	L21	L22	L26	L33	L34	L35	L37	Veneer
60 x 72	racetrack or boat	stationary	GYT2 6072?T S	2	36"	TT	1480	2775	3715	4175	Contact Factory											
60 x 72	racetrack or boat	stationary	GYT2 6072?T S	2	36"	TT	1700	2850	3430	3710	Contact Factory											
60 x 84	rectangle	stationary	GYT2 6084RE S	2	36"	TT	1670	2825	3865	4375	Contact Factory											
60 x 84	racetrack or boat	stationary	GYT2 6084?T S	2	36"	TT	1890	2905	3955	4475	Contact Factory											
60 x 96	rectangle	stationary	GYT2 6096RE S	2	36"	TT	1680	2985	4135	4710	Contact Factory											
60 x 96	racetrack or boat	stationary	GYT2 6096?T S	2	36"	TT	1900	3060	4220	4800	Contact Factory											
60 x 120	rectangle	stationary	GYT2 60120RE S	3	36"	TT	2265	3725	5165	5880	Contact Factory											
60 x 120	racetrack or boat	stationary	GYT2 60120?T S	3	36"	TT	2485	3805	5185	5865	Contact Factory											
60 x 144	rectangle	stationary	GYT2 60144RE S	4	36"	TT	3235	4575	6305	7165	Contact Factory											
60 x 144	racetrack or boat	stationary	GYT2 60144?T S	4	36"	TT	3455	4650	6400	7265	Contact Factory											
60 x 168	rectangle	stationary	GYT2 60168RE S	4	36"	TT	3265	5015	7265	8385	Contact Factory											
60 x 168	racetrack or boat	stationary	GYT2 60168?T S	4	36"	TT	3485	5150	7320	8395	Contact Factory											
60 x 192	rectangle	stationary	GYT2 60192RE S	4	36"	TT	3265	5195	7395	8485	Contact Factory											
60 x 192	racetrack or boat	stationary	GYT2 60192?T S	4	36"	TT	3495	5275	7485	8580	Contact Factory											

BASE OPTIONS: [page 45 for base heights]

- Bar Height table (overall table height is 41.5")
- Café Height tables (overall table height is 36")
- Alternate table height shorter than 29"
- Alternate table height taller than 29"
- Adjustable height (spring clip) T-Base only
- Locking Casters (T Bases - Locking Casters are standard on nesting tables)

MODEL CODE

LIST PRICE

- BH \$130 per base
- CH \$130 per base
- SC \$90 per base
- TC \$130 per base
- AH \$280 per base
- CS \$40 per table

TABLE OPTIONS:

- Custom Stain for wood edges and veneers
- Premium Laminate
- Premium Edge-banding

- UCS \$600 per color
- UCL Contact Factory
- UCE Contact Factory

POWER & AV OPTIONS: [page 21- 38]

- Non-powered round ABS plastic Grommet (black or silver) | List location code on page 18
- Non-powered rectangle metal Grommet (black or silver) | List location code on page 18

- G (B/S) \$20 per grommet
- GV (B/S) \$120 per grommet

WIRE MANAGEMENT: [page 40 - 42]

- Customer specified hole cut into top
- Vertical ABS Leg Way for table base (black or silver)
- 36" long Horizontal 4 track Extruded Raceway
- 12" wide x 34" wide Horizontal Conference Trough

- CNC \$250 set up fee per template
- WV (B/S) \$25 per piece
- HW \$80 per piece
- WT \$475 per Tray

Harbor Options

Below are options that are available on all Harbor tables.



Leveler



Locking Caster



Hidden Wheel



BASE OPTIONS: [page 45 for base heights]

- Adding a third base for more support
- Adjustable Height, push-pin (C and T Bases only)
- Table height range 26"-35"
- Table height range 29"-42"
- Bar Height (42" overall table height - 40.75" base height), Stationary tables only.
 - C and T-Base
 - X-Base
- Cafe' Height (36" overall table height - 34.75" base height), Stationary tables only.
 - C and T-Base
 - TT-Base
 - X-Base
- Custom Height (shorter than 27.75") Stationary only, call factory for folding and nesting
 - C and T-Base
 - TT-Base
 - X-Base
- Custom Height (taller than 27.75") Stationary only, call factory for nesting
 - C and T-Base
 - TT-Base
 - X-Base
- Casters, locking
 - C and T-Base
 - TT-Base
 - X-Base
- Hidden Wheels
 - C and T Base
 - TT-Base
- Polished Aluminum
 - T-Base
 - TT-Base
 - X-Base
- Self-adjustable glides on base
- Metal to Metal threaded inserts. Factory Installed.

TABLE OPTIONS

- Custom Stain for wood edges and veneers
- Premium Laminate
- Premium Edge-banding

POWER & AV OPTIONS : [page 21- 38]

- Non-powered round ABS plastic Grommet (black or silver) | List location code on page 18
- Non-powered rectangle metal Grommet (black or silver) | List location code on page 18

MODEL CODE	LIST PRICE
ABHR	\$345 list per base
AH	\$160 per base
AHB	\$220 per base
BH	\$90 per base
BH	\$100 per base
CH	\$90 per base
CH	\$125 per base
CH	\$100 per base
SC	\$75 per base
SC	\$115 per base
SC	\$90 per base
TC	\$90 per base
TC	\$125 per base
TC	\$100 per base
CS	\$40 per base
CS	\$40 per base
CS	\$80 per base
WL	\$95 per base
WL	\$95 per base
CR	\$70 per base
CR	\$155 per base
CR	\$135 per base
SAGS	\$100 per base
TI	\$100 per table
UCS	\$600 per color
UCL	contact factory
UCE	contact factory
G (B/S)	\$20 per grommet
GV (B/S)	\$120 per grommet

MORE OPTIONS CONTINUED ON THE NEXT PAGE

CONTACT FACTORY FOR LAYOUT, SIZE OPTIONS AND SPECIFICATION ASSISTANCE

Example Base Product Code :						Finish Selections:		
<u>HR</u>	<u>T1</u>	<u>36</u>	<u>RD</u>	<u>S</u>	<u>L3</u>	-	Options in	<u>BK</u>
Product	Base	Top	Top	Table	Top		Alphabetical Order	Base
Line	style	size	shape	function	edge			Finish
								<u>7909-60</u>
								Top Laminate or
								Veneer Selection
								<u>BK</u>
								Edge
								Color



Harbor Options

Below are options that are available on all Harbor tables.

WIRE MANAGEMENT: [page 40 - 42]

- Customer specified hole in table top. Template required.
- Vertical ABS leg way for table base (black)
- Vertical ABS leg way for table base (silver)
- Vertical Laser cut holes in top and bottom of base (not available on X-base)
- Horizontal 4-channel ABS extruded raceway
- Horizontal conference wire management trough
- Horizontal J-channel that hangs off perforated metal modesty panel

CNC	\$250 set up fee per template
WR/B	\$25 per base
WR/S	\$25 per base
WB	\$50 per base
WH	\$80 per table
WT	\$475 per trough
WJ	\$210 per panel

ACCESSORIES: [pages 39 - 49 for options]

- Make 120" long (or shorter) tables into two pieces
- Add Radius Corners to table top. (Specify 1", 2", 3", 4", or 5" radius)
- Table gangers | List location code on page 18
(table gangers not available on L9 or wood edge profiles except L16 or W16)
- Steel Anti-sag bar
- Flat Plate, 3"x5"
- Fixed CPU holder width adjustment 2.75" x 5.25"
- Fixed CPU holder width adjustment 5.5" x 9.25"
- Swivel CPU holder width adjustment 2.75" x 5.25"
- Swivel CPU holder width adjustment 5.5" x 9.25"

FJ	\$300 per table
RC	\$100 per table
TG	\$135 per table
AS	\$100 per table
FP	\$20 per plate
C1	\$160 per holder
C2	\$160 per holder
C3	\$260 per holder
C4	\$260 per holder

MODESTY PANELS: 9" High straight panels [page 39]

Laminate (Model Code: ML)		Metal (Model Code: MM)	
30" panel	\$210 list price	30" panel	\$185 list price
36" panel	\$230 list price	36" panel	\$190 list price
42" panel	\$240 list price	42" panel	\$225 list price
48" panel	\$250 list price	48" panel	\$230 list price
60" panel	\$270 list price	60" panel	\$245 list price
72" panel	\$300 list price	72" panel	\$265 list price

CONTACT FACTORY FOR LAYOUT, SIZE OPTIONS AND SPECIFICATION ASSISTANCE

Example Base Product Code :						Finish Selections:		
<u>HR</u>	<u>I1</u>	<u>36</u>	<u>RD</u>	<u>S</u>	<u>L3</u>	-	Options in	<u>BK</u>
Product Line	Base style	Top size	Top shape	Table function	Top edge		Alphabetical Order	Base Finish
								<u>7909-60</u>
								Top Laminate or Veneer Selection
								<u>BK</u>
								Edge Color

Lead Times: 4 - 6 weeks laminate table | 6 - 8 weeks for wood edged tables | 8-10 weeks for wood veneer tables and customs

Finishes: Pages 4-9 | Power: Pages 21-38 | Options: Pages 39-49

Laminate

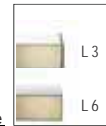

HALF ROUND
T style base

Table Size	Top Shape	Table Function	Model Code:	Base QTY	Base Spread	Base Style		
24 x 48	half round	stationary	HRT1 2448HR S	2	20"	T	990	Contact Factory for all other edges
24 x 48	half round	nesting	HRT1 2448HR N	2	20"	T	1475	Contact Factory for all other edges
30 x 60	half round	stationary	HRT1 3060HR S	2	26"	T	1150	Contact Factory for all other edges
30 x 60	half round	nesting	HRT1 3060HR N	2	26"	T	1645	Contact Factory for all other edges
36 x 72	half round	stationary	HRT1 3672HR S	2	26"	T	1330	Contact Factory for all other edges
36 x 72	half round	nesting	HRT1 3672HR N	2	26"	T	1825	Contact Factory for all other edges
24 x 48	half round	stationary	HRC1 2448HR S	2	20"	C	990	Contact Factory for all other edges
24 x 48	half round	nesting	HRC1 2448HR N	2	20"	C	1475	Contact Factory for all other edges
30 x 60	half round	stationary	HRC1 3060HR S	2	26"	C	1150	Contact Factory for all other edges
30 x 60	half round	nesting	HRC1 3060HR N	2	26"	C	1645	Contact Factory for all other edges
36 x 72	half round	stationary	HRC1 3672HR S	2	26"	C	1330	Contact Factory for all other edges
36 x 72	half round	nesting	HRC1 3672HR N	2	26"	C	1825	Contact Factory for all other edges



TRAPEZOID
T style base

24 x 60	trapezoid	stationary	HRT1 2460TZ S	2	20"	T	1165	Contact Factory for all other edges
24 x 60	trapezoid	nesting	HRT1 2460TZ N	2	20"	T	1650	Contact Factory for all other edges
24 x 72	trapezoid	stationary	HRT1 2472TZ S	2	20"	T	1225	Contact Factory for all other edges
24 x 72	trapezoid	nesting	HRT1 2472TZ N	2	20"	T	1710	Contact Factory for all other edges
30 x 60	trapezoid	stationary	HRT1 3060TZ S	2	26"	T	1270	Contact Factory for all other edges
30 x 60	trapezoid	nesting	HRT1 3060TZ N	2	26"	T	1765	Contact Factory for all other edges
30 x 72	trapezoid	stationary	HRT1 3072TZ S	2	26"	T	1340	Contact Factory for all other edges
30 x 72	trapezoid	nesting	HRT1 3072TZ N	2	26"	T	1835	Contact Factory for all other edges

24 x 60	trapezoid	stationary	HRC1 2460TZ S	2	20"	C	1165	Contact Factory for all other edges
24 x 60	trapezoid	nesting	HRC1 2460TZ N	2	20"	C	1650	Contact Factory for all other edges
24 x 72	trapezoid	stationary	HRC1 2472TZ S	2	20"	C	1225	Contact Factory for all other edges
24 x 72	trapezoid	nesting	HRC1 2472TZ N	2	20"	C	1710	Contact Factory for all other edges
30 x 60	trapezoid	stationary	HRC1 3060TZ S	2	26"	C	1270	Contact Factory for all other edges
30 x 60	trapezoid	nesting	HRC1 3060TZ N	2	26"	C	1765	Contact Factory for all other edges
30 x 72	trapezoid	stationary	HRC1 3072TZ S	2	26"	C	1340	Contact Factory for all other edges
30 x 72	trapezoid	nesting	HRC1 3072TZ N	2	26"	C	1835	Contact Factory for all other edges

24 x 48	crescent	stationary	HRT1 2448CR S	2	20"	T	1135	Contact Factory for all other edges
24 x 48	crescent	nesting	HRT1 2448CR N	2	20"	T	1620	Contact Factory for all other edges
30 x 60	crescent	stationary	HRT1 3060CR S	2	26"	T	1290	Contact Factory for all other edges
30 x 60	crescent	nesting	HRT1 3060CR N	2	26"	T	1785	Contact Factory for all other edges
36 x 72	crescent	stationary	HRT1 3672CR S	2	26"	T	1650	Contact Factory for all other edges

24 x 48	crescent	stationary	HRC1 2448CR S	2	20"	C	1135	Contact Factory for all other edges
24 x 48	crescent	nesting	HRC1 2448CR N	2	20"	C	1620	Contact Factory for all other edges
30 x 60	crescent	stationary	HRC1 3060CR S	2	26"	C	1290	Contact Factory for all other edges
30 x 60	crescent	nesting	HRC1 3060CR N	2	26"	C	1785	Contact Factory for all other edges
36 x 72	crescent	stationary	HRC1 3672CR S	2	26"	C	1650	Contact Factory for all other edges

BASE OPTIONS: [page 45 for base heights]

Adjustable Height, push-pin (C and T Bases only)

Table height range 26"-35"

Table height range 29"-42"

Bar Height (42" overall table height - 40.75" base height), Stationary tables only. (C and T-Base)

Cafe' Height (36" overall table height - 34.75" base height), Stationary tables only. (C and T-Base)

Casters, locking (C and T-Base)

Hidden Wheels (C and T-Base)

Polished Aluminum (C and T-Base)

Self-adjustable glides on base

MODEL CODE LIST PRICE

AH	\$160 per base
AHB	\$220 per base
BH	\$90 per base
CH	\$90 per base
CS	\$40 per base
WL	\$95 per base
CR	\$70 per base
SAGS	\$100 per base

POWER & A/V OPTIONS: [page 21- 38]

WIRE MANAGEMENT: [page 40 - 42]

ACCESSORIES: [pages 39 - 49 for options]

MODESTY PANELS: 9" High straight panels [page 39]



How to Order:

Email orders to: sales@hi5furniture.com

1. Choose your base model
2. Add edge code to base model
3. Choose finishes
4. Select options to add to table
5. Select finishes of options

NOTE: Nesting tables come standard on locking casters.

Laminate & FormaWrap Tables

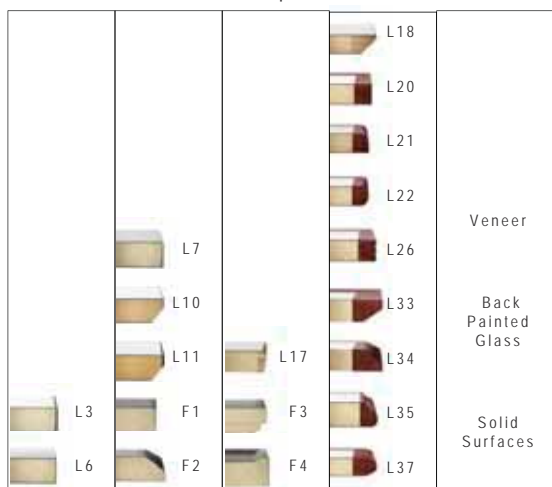

Table Size	Top Shape	Table Function	Model Code:	Base QTY	Base Spread	Base Style					
30"	round	stationary	HRX1 30RD S	1	26"	X	1050	1160	1255	1330	Contact Factory
30"	round	nesting	HRX1 30RD N	1	26"	X	1285	1395	1490	1565	Contact Factory
36"	round	stationary	HRX1 36RD S	1	26"	X	1115	1225	1520	1625	Contact Factory
36"	round	nesting	HRX1 36RD N	1	26"	X	1350	1460	1755	1860	Contact Factory
42"	round	stationary	HRX1 42RD S	1	36"	X	1245	1360	2035	2180	Contact Factory
42"	round	nesting	HRX1 42RD N	1	36"	X	1475	1590	2265	2410	Contact Factory
48"	round	stationary	HRX1 48RD S	1	36"	X	1255	1365	2310	2495	Contact Factory
48"	round	nesting	HRX1 48RD N	1	36"	X	1485	1595	2540	2725	Contact Factory
30"	square	stationary	HRX1 30SQ S	1	26"	X	1000	1055*	1180	1270	Contact Factory
30"	square	nesting	HRX1 30SQ N	1	26"	X	1235	1290*	1415	1505	Contact Factory
36"	square	stationary	HRX1 36SQ S	1	26"	X	1060	1120*	1280	1545	Contact Factory
36"	square	nesting	HRX1 36SQ N	1	26"	X	1295	1355*	1515	1780	Contact Factory
42"	square	stationary	HRX1 42SQ S	1	36"	X	1195	1265	1645	2090	Contact Factory
42"	square	nesting	HRX1 42SQ N	1	36"	X	1425	1495	1875	2320	Contact Factory
48"	square	stationary	HRX1 48SQ S	1	36"	X	1205	1280	1885	2350	Contact Factory
48"	square	nesting	HRX1 48SQ N	1	36"	X	1435	1510	2115	2580	Contact Factory

BASE OPTIONS: [page 45 for base heights]

Adjustable Height, push-pin (C and T Bases only)

Table height range 26"-35"

Table height range 29"-42"

Bar Height (42" overall table height - 40.75" base height), Stationary tables only.

X-Base

Cafe' Height (36" overall table height - 34.75" base height), Stationary tables only.

X-Base

Casters, locking

X-Base

Polished Aluminum

X-Base

Self-adjustable glides on base

Metal to Metal threaded inserts. Factory Installed.

MODEL CODE

LIST PRICE

AH	\$160 per base
AHB	\$220 per base
BH	\$100 per base
CH	\$100 per base
CS	\$80 per base
CR	\$135 per base
SAGS	\$100 per base
TI	\$100 per table

TABLE OPTIONS

Custom Stain for wood edges and veneers

Premium Laminate

Premium Edge-banding

UCS	\$600 per color
UCL	Contact Factory
UCE	Contact Factory

ACCESSORIES: [pages 39 - 49 for options]

Add Radius Corners to table top. (Specify 1", 2", 3", 4", or 5" radius)

RC	\$100 per table
----	-----------------



T style base C style base

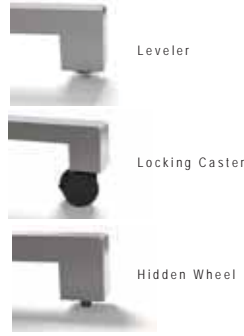

How to Order:
 Email orders to: sales@hi5furniture.com
 1. Choose your base model
 2. Add edge code to base model
 3. Choose finishes
 4. Select options to add to table
 5. Select finishes of options

NOTE: Nesting tables come standard on locking casters.
 For C bases instead of T - substitute the HRT with HRC in the model code. List pricing is the same.

Laminate & FormaWrap Tables



Table Size	Top Shape	Table Function	Model Code:	Base QTY	Base Spread	Base Style					
18 x 48	rectangle	stationary	HRT1 1848RE S	2	17"	T	950	1010	1205	1445	Contact Factory
18 x 48	rectangle	folding	HRT1 1848RE F	2	17"	T	1350	1410	1605	1845	Contact Factory
18 x 48	rectangle	nesting	HRT1 1848RE N	2	17"	T	1445	1505	1700	1940	Contact Factory
18 x 60	rectangle	stationary	HRT1 1860RE S	2	17"	T	1020	1085	1350	1640	Contact Factory
18 x 60	rectangle	folding	HRT1 1860RE F	2	17"	T	1330	1425	1690	1980	Contact Factory
18 x 60	rectangle	nesting	HRT1 1860RE N	2	17"	T	1515	1580	1845	2135	Contact Factory
18 x 72	rectangle	stationary	HRT1 1872RE S	2	17"	T	1080	1160	1495	1850	Contact Factory
18 x 72	rectangle	folding	HRT1 1872RE F	2	17"	T	1420	1500	1835	2190	Contact Factory
18 x 72	rectangle	nesting	HRT1 1872RE N	2	17"	T	1575	1655	1990	2345	Contact Factory
18 x 84	rectangle	stationary	HRT1 1884RE S	2	17"	T	1115	1195	1780	2235	Contact Factory
18 x 84	rectangle	folding	HRT1 1884RE F	2	17"	T	1455	1535	2120	2820	Contact Factory
18 x 96	rectangle	stationary	HRT1 1896RE S	2	17"	T	1120	1215	1790	2245	Contact Factory
18 x 96	rectangle	folding	HRT1 1896RE F	2	17"	T	1430	1525	2100	2555	Contact Factory

BASE OPTIONS: [page 45 for base heights]

- Adjustable Height, push-pin (C and T Bases only)
 - Table height range 26"-35"
 - Table height range 29"-42"
- Bar Height (42" overall table height - 40.75" base height), Stationary tables only. (C and T-Base)
- Cafe' Height (36" overall table height - 34.75" base height), Stationary tables only. (C and T-Base)
- Castors, locking (C and T-Base)
- Hidden Wheels (C and T-Base)
- Polished Aluminum (C and T-Base)
- Self-adjustable glides on base

MODEL CODE LIST PRICE

- AH \$160 per base
- AHB \$220 per base
- BH \$90 per base
- CH \$90 per base
- CS \$40 per base
- WL \$95 per base
- CR \$70 per base
- SAGS \$100 per base

POWER & A/V OPTIONS : [page 21-38]

- Non-powered round ABS plastic Grommet (black or silver) | List location code on page 18
- Non-powered rectangle metal Grommet (black or silver) | List location code on page 18

- G (B/S) \$20 per grommet
- GV (B/S) \$120 per grommet

WIRE MANAGEMENT: [page 40 - 42]

- Customer specified hole cut into top
- Vertical ABS Leg Way for table base (black or silver)
- 36" long Horizontal 4 track Extruded Raceway
- J-channel that attaches to Metal Modesty Panel

- CNC \$250 set up fee per template
- WV (B/S) \$25 per piece
- HW \$80 per piece
- WJ \$210 per table

ACCESSORIES: [pages 39 - 49 for options]

- Table Gangers (per set) (N/A on wood edge tops)

- TG \$135 per set

MODESTY PANELS: 9" High straight panels [page 39]

Laminate (Model Code: ML)	Metal (Model Code: MM)
30" panel \$210 list price	30" panel \$185 list price
36" panel \$230 list price	36" panel \$190 list price
42" panel \$240 list price	42" panel \$225 list price
48" panel \$250 list price	48" panel \$230 list price
60" panel \$270 list price	60" panel \$245 list price
72" panel \$300 list price	72" panel \$265 list price



T Style base C style base

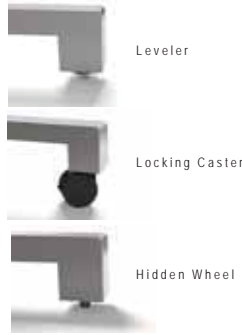

Leveler
 Locking Caster
 Hidden Wheel

How to Order:
 Email orders to: sales@hi5furniture.com
 1. Choose your base model
 2. Add edge code to base model
 3. Choose finishes
 4. Select options to add to table
 5. Select finishes of options

NOTE: Nesting tables come standard on locking casters.
 For C bases instead of T – substitute the HRT with HRC in the model code. List pricing is the same.

Laminate & FormaWrap Tables



Table Size	Top Shape	Table Function	Table Model Code:	Base QTY	Base Spread	Base Style	L3	F1	F3	F4	L6	L7	L10	L11	L17	L20	L21	L22	L26	L33	L34	L35	L37	Category	
30 x 48	rectangle	stationary	HRT1 3048RE S	2	26"	T	1070																		Contact Factory
30 x 48	rectangle	folding	HRT1 3048RE F	2	26"	T	1460																		Contact Factory
30 x 48	rectangle	nesting	HRT1 3048RE N	2	26"	T	1565																		Contact Factory
30 x 60	rectangle	stationary	HRT1 3060RE S	2	26"	T	1150																		Contact Factory
30 x 60	rectangle	folding	HRT1 3060RE F	2	26"	T	1450																		Contact Factory
30 x 60	rectangle	nesting	HRT1 3060RE N	2	26"	T	1645																		Contact Factory
30 x 72	rectangle	stationary	HRT1 3072RE S	2	26"	T	1230																		Contact Factory
30 x 72	rectangle	folding	HRT1 3072RE F	2	26"	T	1530																		Contact Factory
30 x 72	rectangle	nesting	HRT1 3072RE N	2	26"	T	1725																		Contact Factory
30 x 84	rectangle	stationary	HRT1 3084RE S	2	26"	T	1255																		Contact Factory
30 x 84	rectangle	folding	HRT1 3084RE F	2	26"	T	1555																		Contact Factory
30 x 96	rectangle	stationary	HRT1 3096RE S	2	26"	T	1265																		Contact Factory
30 x 96	rectangle	folding	HRT1 3096RE F	2	26"	T	1565																		Contact Factory

BASE OPTIONS: [page 45 for base heights]

- Adjustable Height, push-pin (C and T Bases only)
 - Table height range 26"-35"
 - Table height range 29"-42"
- Bar Height (42" overall table height - 40.75" base height), Stationary tables only. (C and T-Base)
- Cafe Height (36" overall table height - 34.75" base height), Stationary tables only. (C and T-Base)
- Casters, locking (C and T-Base)
- Hidden Wheels (C and T-Base)
- Polished Aluminum (C and T-Base)
- Self-adjustable glides on base

MODEL CODE LIST PRICE

- AH \$160 per base
- AHB \$220 per base
- BH \$90 per base
- CH \$90 per base
- CS \$40 per base
- WL \$95 per base
- CR \$70 per base
- SAGS \$100 per base

POWER & A/V OPTIONS: [page 21- 38]

- Non-powered round ABS plastic Grommet (black or silver) | List location code on page 18
- Non-powered rectangle metal Grommet (black or silver) | List location code on page 18

- G (B/S) \$20 per grommet
- GV (B/S) \$120 per grommet

WIRE MANAGEMENT: [page 40 - 42]

- Customer specified hole cut into top
- Vertical ABS Leg Way for table base (black or silver)
- 36" long Horizontal 4 track Extruded Raceway
- J-channel that attaches to Metal Modesty Panel

- CNC \$250 set up fee per template
- WV (B/S) \$25 per piece
- HW \$80 per piece
- WJ \$210 per table

ACCESSORIES: [pages 39 - 49 for options]

- Table Gangers (per set) (N/A on wood edge tops)

- TG \$135 per set

MODESTY PANELS: 9" High straight panels [page 39]

Laminate (Model Code: ML)	Metal (Model Code: MM)
30" panel \$210 list price	30" panel \$185 list price
36" panel \$230 list price	36" panel \$190 list price
42" panel \$240 list price	42" panel \$225 list price
48" panel \$250 list price	48" panel \$230 list price
60" panel \$270 list price	60" panel \$245 list price
72" panel \$300 list price	72" panel \$265 list price



How to Order:

- Email orders to: sales@hi5furniture.com
1. Choose your base model
 2. Add edge code to base model
 3. Choose finishes
 4. Select options to add to table
 5. Select finishes of options

Racetrack or Boat Shaped Tables:

Replace the ? with an RT (for Racetrack) or a BT (for Boat) to complete the model code. [ex. HRT1 3060BT S - for a 30x60 boat]

Table Size	Top Shape	Table Function	Model Code:	Base QTY	Base Spread	Base Style	L3	F1	F2	F3	F4	L6	L7	L10	L11	L17	L33	L34	L35	L37	Contract Factory
30 x 60	racetrack or boat	stationary	HRT1 3060?T S	2	26"	T	1150	1225	1955	2180	Contract Factory										
30 x 72	racetrack or boat	stationary	HRT1 3072?T S	2	26"	T	1230	1315	2130	2440	Contract Factory										
30 x 84	racetrack or boat	stationary	HRT1 3084?T S	2	26"	T	1255	1345	2485	2920	Contract Factory										
30 x 96	racetrack or boat	stationary	HRT1 3096?T S	2	26"	T	1265	1365	2490	2970	Contract Factory										
36 x 48	rectangle	stationary	HRT1 3648RE S	2	26"	T	1145	1215	1530	1880	Contract Factory										
36 x 60	rectangle	stationary	HRT1 3660RE S	2	26"	T	1240	1320	1740	2175	Contract Factory										
36 x 72	rectangle	stationary	HRT1 3672RE S	2	26"	T	1330	1425	1950	2485	Contract Factory										
36 x 84	rectangle	stationary	HRT2 3684RE S	2	35"	TT	1540	1665	2360	3065	Contract Factory										
36 x 96	rectangle	stationary	HRT2 3696RE S	2	35"	TT	1550	1680	2385	3090	Contract Factory										
36 x 120	rectangle	stationary	HRT2 36120RE S	3	35"	TT	2080	2240	3275	4050	Contract Factory										
36 x 60	racetrack or boat	stationary	HRT1 3660?T S	2	26"	T	1240	1320	2130	2425	Contract Factory										
36 x 72	racetrack or boat	stationary	HRT1 3672?T S	2	26"	T	1330	1425	2340	2735	Contract Factory										
36 x 84	racetrack or boat	stationary	HRT2 3684?T S	2	26"	TT	1540	1665	2760	3315	Contract Factory										
36 x 96	racetrack or boat	stationary	HRT2 3696?T S	2	26"	TT	1550	1680	2780	3325	Contract Factory										

Laminate & FormaWrap Tables

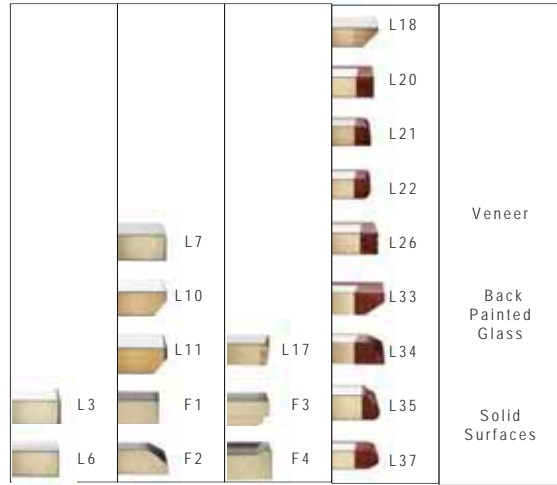

BASE OPTIONS: [page 45 for base heights]

- Bar Height (42" overall table height - 40.75" base height), Stationary tables only.
- Cafe' Height (36" overall table height - 34.75" base height), Stationary tables only.
- Casters, locking
- Hidden Wheels
- Polished Aluminum
- Self-adjustable glides on base

MODEL CODE

LIST PRICE

- BH \$125 per base
- CH \$125 per base
- CS \$40 per base
- WL \$95 per base
- CR \$155 per base
- SAGS \$100 per base

TABLE OPTIONS

- Custom Stain for wood edges and veneers
- Premium Laminate
- Premium Edge-banding

- UCS \$600 per color
- UCL contact factory
- UCE contact factory

POWER & A/V OPTIONS: [page 21 - 38]

- Non-powered round ABS plastic Grommet (black or silver) | List location code on page 18
- Non-powered rectangle metal Grommet (black or silver) | List location code on page 18

- G (B/S) \$20 per grommet
- GV (B/S) \$120 per grommet

WIRE MANAGEMENT: [page 40 - 42]

- Customer specified hole in table top. Template required.
- Vertical ABS leg way for table base (black)
- Vertical ABS leg way for table base (silver)
- Vertical Laser cut holes in top and bottom of base (not available on X-base)
- Horizontal 4-channel ABS extruded raceway
- Horizontal conference wire management trough
- Horizontal J-channel that hangs off perforated metal modesty panel

- CNC \$250 set up fee per template
- WR/B \$25 per base
- WR/S \$25 per base
- WB \$50 per base
- WH \$80 per table
- WT \$475 per trough
- WJ \$210 per panel



How to Order:

Email orders to: sales@hi5furniture.com

1. Choose your base model
2. Add edge code to base model
3. Choose finishes
4. Select options to add to table
5. Select finishes of options

Racetrack or Boat Shaped Tables:

Replace the ? with an RT (for Racetrack) or a BT (for Boat) to complete the model code. [ex. HRT1 3060BTT S - for a 30x60 boat]

Table Size	Top Shape	Table Function	Model Code:	Base QTY	Base Spread	Base Style						
48 x 60	rectangle	stationary	HRT2 4860RE S	2	35"	TT	1660	1745	2540	3110	Contact Factory	
48 x 72	rectangle	stationary	HRT2 4872RE S	2	35"	TT	1750	1850	2825	3515	Contact Factory	
48 x 84	rectangle	stationary	HRT2 4884RE S	2	35"	TT	1960	2090	3395	4320	Contact Factory	
48 x 96	rectangle	stationary	HRT2 4896RE S	2	35"	TT	1975	2110	3400	4330	Contact Factory	
48 x 120	rectangle	stationary	HRT2 48120RE S	3	35"	TT	2710	2870	4650	5680	Contact Factory	
48 x 144	rectangle	stationary	HRT2 48144RE S	4	35"	TT	3445	3630	5780	7050	Contact Factory	
48 x 168	rectangle	stationary	HRT2 48168RE S	4	35"	TT	4100	4385	6380	7830	Contact Factory	
48 x 192	rectangle	stationary	HRT2 48192RE S	4	35"	TT	4130	4420	6975	8635	Contact Factory	
60 x 72	rectangle	stationary	HRT2 6072RE S	2	35"	TT	1885	2005	3340	4115	Contact Factory	
60 x 84	rectangle	stationary	HRT2 6084RE S	2	35"	TT	2130	2290	4085	5120	Contact Factory	
60 x 96	rectangle	stationary	HRT2 6096RE S	2	35"	TT	2145	2305	4090	5130	Contact Factory	
60 x 120	rectangle	stationary	HRT2 60120RE S	3	35"	TT	2920	3110	5390	6680	Contact Factory	
60 x 144	rectangle	stationary	HRT2 60144RE S	4	35"	TT	3690	3915	6700	8250	Contact Factory	
60 x 168	rectangle	stationary	HRT2 60168RE S	4	35"	TT	4460	4800	7420	9235	Contact Factory	
60 x 192	rectangle	stationary	HRT2 60192RE S	4	35"	TT	4490	4830	8165	10,245	Contact Factory	
48 x 60	racetrack or boat	stationary	HRT2 4860?T S	2	35"	TT	1755	1855	2820	3365	Contact Factory	
48 x 72	racetrack or boat	stationary	HRT2 4872?T S	2	35"	TT	1840	1950	3115	3765	Contact Factory	
48 x 84	racetrack or boat	stationary	HRT2 4884?T S	2	35"	TT	2045	2185	3700	4820	Contact Factory	
48 x 96	racetrack or boat	stationary	HRT2 4896?T S	2	35"	TT	2050	2195	3710	4830	Contact Factory	
48 x 120	racetrack or boat	stationary	HRT2 48120?T S	3	35"	TT	2790	2960	5090	6190	Contact Factory	
48 x 144	racetrack or boat	stationary	HRT2 48144?T S	4	35"	TT	3530	3725	6240	7550	Contact Factory	
48 x 168	racetrack or boat	stationary	HRT2 48168?T S	4	35"	TT	4145	4230	6830	8335	Contact Factory	
48 x 192	racetrack or boat	stationary	HRT2 48192?T S	4	35"	TT	4180	4475	7425	9135	Contact Factory	
60 x 72	racetrack or boat	stationary	HRT2 6072?T S	2	35"	TT	1965	2095	3565	4370	Contact Factory	
60 x 84	racetrack or boat	stationary	HRT2 6084?T S	2	35"	TT	2210	2375	4535	5620	Contact Factory	
60 x 96	racetrack or boat	stationary	HRT2 6096?T S	2	35"	TT	2215	2385	4540	5640	Contact Factory	
60 x 120	racetrack or boat	stationary	HRT2 60120?T S	3	35"	TT	2990	3195	5840	7200	Contact Factory	
60 x 144	racetrack or boat	stationary	HRT2 60144?T S	4	35"	TT	3770	4005	7140	8750	Contact Factory	
60 x 168	racetrack or boat	stationary	HRT2 60168?T S	4	35"	TT	4500	4840	7875	9740	Contact Factory	
60 x 192	racetrack or boat	stationary	HRT2 60192?T S	4	35"	TT	4530	4880	8620	10,745	Contact Factory	

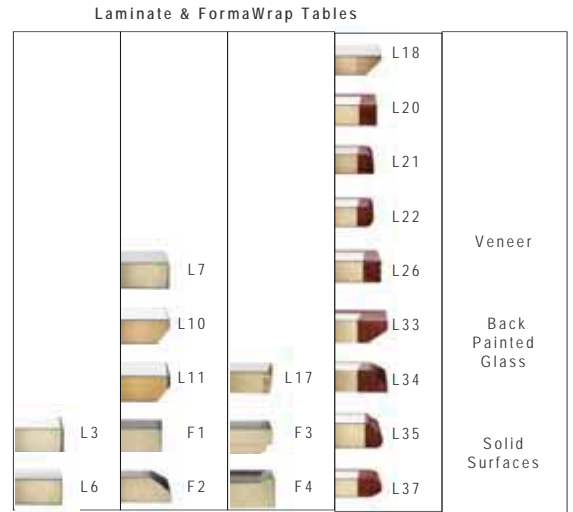

BASE OPTIONS: [page 45 for base heights]

- Bar Height (42" overall table height - 40.75" base height), Stationary tables only.
- Cafe Height (36" overall table height - 34.75" base height), Stationary tables only.
- Hidden Wheels
- Polished Aluminum

MODEL CODE	LIST PRICE
BH	\$125 per base
CH	\$125 per base
WL	\$95 per base
CR	\$155 per base

TABLE OPTIONS

- Custom Stain for wood edges and veneers

UCS	\$600 per color
-----	-----------------

POWER & A/V OPTIONS: [page 21- 38]

- Non-powered round ABS plastic Grommet (black or silver) | List location code on page 18
- Non-powered rectangle metal Grommet (black or silver) | List location code on page 18

G (B/S)	\$20 per grommet
GV (B/S)	\$120 per grommet

WIRE MANAGEMENT: [page 40 - 42]

- Vertical ABS leg way for table base (black)
- Vertical ABS leg way for table base (silver)
- Vertical Laser cut holes in top and bottom of base (not available on X-base)
- Horizontal 4-channel ABS extruded raceway
- Horizontal conference wire management trough
- Horizontal J-channel that hangs off perforated metal modesty panel

WR/B	\$25 per base
WR/S	\$25 per base
WB	\$50 per base
WH	\$80 per table
WT	\$475 per trough
WJ	\$210 per panel

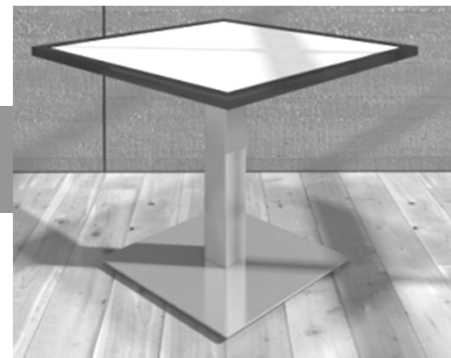

Island Options

Below are options that are available on all Island tables.

BASE OPTIONS: [page 45 for base heights]

- Add Levelers – Raises base 1" off of the floor
- Bar Height on round bases (overall table height is 42")
- Bar Height on square bases (overall table height is 42")
- Café Height on round bases (overall table height is 36")
- Café Height on square bases (overall table height is 36")
- Alternate table height shorter than 29"
- Alternate table height taller than 29"
- Adjustable height (spring clip)
- Polished Chrome on 18" and 24" round bases
- Self-adjustable glides on base
- Metal to Metal threaded inserts. Factory Installed.

TABLE OPTIONS:

- Add Radius Corners to table top. (Specify 1", 2", 3", 4", or 5" radius)
- Custom Stain for wood edges and veneers
- Premium Laminate
- Premium Edge-banding

POWER & A/V OPTIONS : [page 21- 38]

- Non-powered round ABS plastic Grommet (black or silver) | List location code on page 18
- Non-powered rectangle metal Grommet (black or silver) | List location code on page 18

WIRE MANAGEMENT: [page 40 - 42]

- Customer specified hole cut into top
- Vertical ABS Leg Way for table base (black or silver)
- 36" long Horizontal 4 track Extruded Raceway
- 12" wide x 34" wide Horizontal Conference Trough
- Laser cut holes in the base – 1.5" holes cut into top and bottom of base for wire mgmt.

ACCESSORIES: [page 42 for support/ganging options, page 46 for misc. options]

- Table Gangers (per set) (N/A on wood edge tops)
- Quick release table gangers. Factory installed. Ships attached to the table tops.
- Flat Plate, 3"x5"
- Customer specified hole cut into top

MODEL CODE

LIST PRICE

LV	\$80 per table
BH	\$90 per table
BH	\$150 per table
CH	\$90 per table
CH	\$150 per table
SC	\$90 per table
TC	\$130 per table
AH	\$280 per table
CR	\$225 per table
SAGS	\$100 per base
TI	\$100 per table
RC	\$100 per table
UCS	\$600 per color
UCL	Contact Factory
UCE	Contact Factory
G (B/S)	\$20 per grommet
GV (B/S)	\$120 per grommet
CNC	\$250 set up fee per template
WV (S/B)	\$25 list per piece
WH	\$80 per piece
WT	\$475 list per Tray
WB	\$50 per base
TG	\$135 per set
QR	\$135 per table
FP	\$20 per plate
CNC	\$250 set up fee per template

Contact Factory FOR LAYOUT, SIZE OPTIONS AND SPECIFICATION ASSISTANCE

Example Base Product Code :						Finish Selections:			
<u>ID</u>	<u>D1</u>	<u>3060</u>	<u>RE</u>	<u>S</u>	<u>L3</u>	-	Options in		
Product Line	Base style	Top size	Top shape	Table function	Top edge		Alphabetical Order		
							<u>BK</u>	<u>7909-60</u>	<u>BK</u>
							Base Finish	Top Laminate or Veneer Selection	Edge Color



How to Order:

Email orders to: sales@hi5furniture.com

1. Choose your base model
2. Add edge code to base model
3. Choose finishes
4. Select options to add to table
5. Select finishes of options

Laminate & FormaWrap Tables

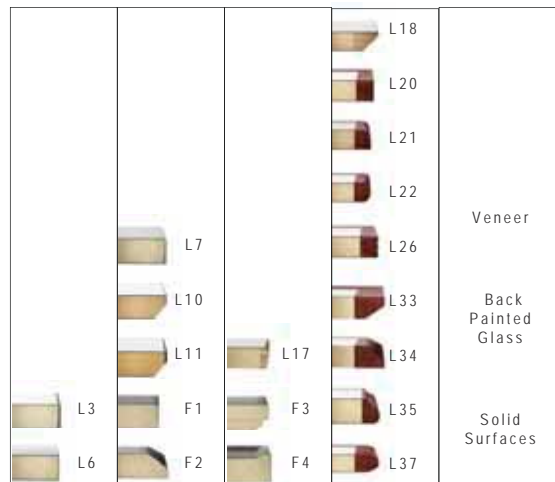

Table Size	Top Shape	Model Code:	Top QTY	Base QTY	Base Size	Column Diameter	Base Shape					
24"	Round	IDD1 24RD S	1	1	18"	4"	Round Base	865	975	1185	1285	Contact Factory
24"	Round	IDQ1 24RD S	1	1	18"	4"	Square Base	1110	1215	1235	1255	Contact Factory
24"	Square	IDD1 24SQ S	1	1	18"	4"	Round Base	795	900	1095	1190	Contact Factory
24"	Square	IDQ1 24SQ S	1	1	18"	4"	Square Base	1060	1110	1120	1170	Contact Factory
30"	Round	IDD1 30RD S	1	1	18"	4"	Round Base	900	1055	1315	1440	Contact Factory
30"	Round	IDQ1 30RD S	1	1	18"	4"	Square Base	1170	1280	1375	1450	Contact Factory
30"	Square	IDD1 30SQ S	1	1	18"	4"	Round Base	840	970	1225	1350	Contact Factory
30"	Square	IDQ1 30SQ S	1	1	18"	4"	Square Base	1120	1175	1300	1390	Contact Factory
36"	Round	IDD1 36RD S	1	1	18"	4"	Round Base	1015	1140	1470	1635	Contact Factory
36"	Round	IDQ1 36RD S	1	1	18"	4"	Square Base	1235	1345	1640	1745	Contact Factory
36"	Square	IDD1 36SQ S	1	1	24"	4"	Round Base	1040	1165	1495	1655	Contact Factory
36"	Square	IDQ1 36SQ S	1	1	24"	4"	Square Base	1310	1370	1530	1795	Contact Factory
42"	Round	IDD1 42RD S	1	1	24"	4"	Round Base	1265	1340	1775	1990	Contact Factory
42"	Round	IDQ1 42RD S	1	1	24"	4"	Square Base	1380	1495	2170	2315	Contact Factory
42"	Square	IDD1 42SQ S	1	1	24"	4"	Round Base	1285	1540	1980	2195	Contact Factory
42"	Square	IDQ1 42SQ S	1	1	24"	4"	Square Base	1330	1400	1780	2225	Contact Factory
48"	Round	IDD1 48RD S	1	1	24"	4"	Round Base	1470	1660*	2185	2445	Contact Factory
48"	Round	IDQ1 48RD S	1	1	24"	6"	Square Base	1390	1500	2445	2630	Contact Factory
48"	Square	IDD1 48SQ S	1	1	28"	4"	Round Base	1340	1580	2100	2355	Contact Factory
48"	Square	IDQ1 48SQ S	1	1	24"	6"	Square Base	1530	1605	2210	2675	Contact Factory
60"	Round	IDD1 60RD S	1	1	32"	6"	Round Base	2085	2210	3805	4100	Contact Factory

BASE OPTIONS: [page 45 for base heights]

- Add Levelers - Raises base 1" off of the floor
- Bar Height on round bases (overall table height is 42")
- Bar Height on square bases (overall table height is 42")
- Café Height on round bases (overall table height is 36")
- Café Height on square bases (overall table height is 36")
- Alternate table height shorter than 29"
- Alternate table height taller than 29"
- Adjustable height (spring clip)
- Polished Chrome on 18" and 24" round bases
- Self-adjustable glides on base
- Metal to Metal threaded inserts. Factory Installed.

MODEL CODE LIST PRICE

- LV \$80 per table
- BH \$90 per table
- BH \$150 per table
- CH \$90 per table
- CH \$150 per table
- SC \$90 per table
- TC \$130 per table
- AH \$280 per table
- CR \$225 per table
- SAGS \$100 per base
- TI \$100 per table

TABLE OPTIONS:

- Add Radius Corners to table top. (Specify 1", 2", 3", 4", or 5" radius)
- Custom Stain for wood edges and veneers
- Premium Laminate
- Premium Edge-banding

- RC \$100 per table
- UCS \$600 per color
- UCL Contact Factory
- UCE Contact Factory

POWER & A/V OPTIONS: [page 21-38]

- Non-powered round ABS plastic Grommet (black or silver) | List location code on page 18
- Non-powered rectangle metal Grommet (black or silver) | List location code on page 18
- G (B/S) \$20 per grommet
- GV (B/S) \$120 per grommet



How to Order:

Email orders to: sales@hi5furniture.com

1. Choose your base model
2. Add edge code to base model
3. Choose finishes
4. Select options to add to table
5. Select finishes of options

Laminate & FormaWrap Tables



Table Size	Top Shape	Model Code:	Top QTY	Base QTY	Base Size	Column Diameter	Base Shape						
18" x 48"	Rectangle	IDD1 1848RE S	1	2	18"	4"	Round Base	1505	1605	1715	1770	Contact	Factory
18" x 48"	Rectangle	IDQ1 1848RE S	1	2	18"	4"	Square Base	1840	1900	2095	2335	Contact	Factory
18" x 60"	Rectangle	IDD1 1860RE S	1	2	18"	4"	Round Base	1555	1660	1795	1860	Contact	Factory
18" x 60"	Rectangle	IDQ1 1860RE S	1	2	18"	4"	Square Base	1910	1975	2240	2530	Contact	Factory
18" x 72"	Rectangle	IDD1 1872RE S	1	2	18"	4"	Round Base	1590	1715	1875	1955	Contact	Factory
18" x 72"	Rectangle	IDQ1 1872RE S	1	2	18"	4"	Square Base	1970	2050	2385	2740	Contact	Factory
18" x 84"	Rectangle	IDD1 1884RE S	1	2	18"	4"	Round Base	1675	1770	1960	2050	Contact	Factory
18" x 84"	Rectangle	IDQ1 1884RE S	1	2	18"	4"	Square Base	2005	2085	2670	3125	Contact	Factory
18" x 96"	Rectangle	IDD1 1896RE S	1	2	18"	4"	Round Base	1685	1825	2115	2250	Contact	Factory
18" x 96"	Rectangle	IDQ1 1896RE S	1	2	18"	4"	Square Base	2010	2105	2680	3135	Contact	Factory
18" x 120"	Rectangle	IDD1 18120RE S	1	2	18"	4"	Round Base	1940	2050	2780	3340	Contact	Factory
18" x 120"	Rectangle	IDQ1 18120RE S	1	2	18"	4"	Square Base	2120	2230	2960	3520	Contact	Factory
24" x 30"	Rectangle	IDD1 2430RE S	1	1	18"	4"	Round Base	815	930	1110	1150	Contact	Factory
24" x 30"	Rectangle	IDQ1 2430RE S	1	1	18"	4"	Square Base	1070	1120	1180	1265	Contact	Factory
24" x 36"	Rectangle	IDD1 2436RE S	1	1	18"	4"	Round Base	835	965	1180	1230	Contact	Factory
24" x 36"	Rectangle	IDQ1 2436RE S	1	1	18"	4"	Square Base	1080	1130	1205	1365	Contact	Factory
24" x 42"	Rectangle	IDD1 2442RE S	1	1	24"	4"	Round Base	965	1115	1370	1435	Contact	Factory
24" x 42"	Rectangle	IDQ1 2442RE S	1	1	24"	4"	Square Base	1215	1270	1435	1625	Contact	Factory
24" x 48"	Rectangle	IDD1 2448RE S	1	2	18"	4"	Round Base	1520	1670	1955	2025	Contact	Factory
24" x 48"	Rectangle	IDQ1 2448RE S	1	2	18"	4"	Square Base	1860	1920	2115	2335	Contact	Factory
24" x 60"	Rectangle	IDD1 2460RE S	1	2	18"	4"	Round Base	1560	1735	2090	2175	Contact	Factory
24" x 60"	Rectangle	IDQ1 2460RE S	1	2	18"	4"	Square Base	1930	1995	2260	2530	Contact	Factory
24" x 72"	Rectangle	IDD1 2472RE S	1	2	18"	4"	Round Base	1595	1805	2225	2330	Contact	Factory
24" x 72"	Rectangle	IDQ1 2472RE S	1	2	18"	4"	Square Base	1990	2070	2405	2740	Contact	Factory
24" x 84"	Rectangle	IDD1 2484RE S	1	2	18"	4"	Round Base	1680	1870	2365	2490	Contact	Factory
24" x 84"	Rectangle	IDQ1 2484RE S	1	2	18"	4"	Square Base	2025	2105	2690	3125	Contact	Factory
24" x 96"	Rectangle	IDD1 2496RE S	1	2	18"	4"	Round Base	1690	1945	2500	2640	Contact	Factory
24" x 96"	Rectangle	IDQ1 2496RE S	1	2	18"	4"	Square Base	2030	2125	2700	3135	Contact	Factory
24" x 120"	Rectangle	IDD1 24120RE S	1	2	18"	4"	Round Base	1960	2070	2800	3340	Contact	Factory
24" x 120"	Rectangle	IDQ1 24120RE S	1	2	18"	4"	Square Base	2140	2250	2980	3520	Contact	Factory

BASE OPTIONS: [page 45 for base heights]

- Add Levelers – Raises base 1" off of the floor
- Bar Height on round bases (overall table height is 42")
- Bar Height on square bases (overall table height is 42")
- Café Height on round bases (overall table height is 36")
- Café Height on square bases (overall table height is 36")
- Alternate table height shorter than 29"
- Alternate table height taller than 29"
- Adjustable height (spring clip)
- Polished Chrome on 18" and 24" round bases
- Self-adjustable glides on base
- Metal to Metal threaded inserts. Factory Installed.

MODEL CODE

- LV \$80 per table
- BH \$90 per table
- BH \$150 per table
- CH \$90 per table
- CH \$150 per table
- SC \$90 per table
- TC \$130 per table
- AH \$280 per table
- CR \$225 per table
- SAGS \$100 per base
- TI \$100 per table

LIST PRICE

TABLE OPTIONS:

- Add Radius Corners to table top. (Specify 1", 2", 3", 4", or 5" radius)
- Custom Stain for wood edges and veneers
- Premium Laminate
- Premium Edge-banding

- RC \$100 per table
- UCS \$600 per color
- UCL Contact Factory
- UCE Contact Factory

POWER & AV OPTIONS: [page 21- 38]

- Non-powered round ABS plastic Grommet (black or silver) | List location code on page 18
- Non-powered rectangle metal Grommet (black or silver) | List location code on page 18

- G (B/S) \$20 per grommet
- GV (B/S) \$120 per grommet



How to Order:

Email orders to: sales@hi5furniture.com

1. Choose your base model
2. Add edge code to base model
3. Choose finishes
4. Select options to add to table
5. Select finishes of options

Laminate & FormaWrap Tables



Table Size	Top Shape	Model Code:	Top QTY	Base QTY	Base Size	Column Diameter	Base Shape						
30" x 36"	Rectangle	IDD1 3036RE S	1	1	24"	4	round base	1115	1170	1325	1545	Contact Factory	
30" x 36"	Rectangle	IDQ1 3036RE S	1	1	18"	4	square base	1085	1140	1295	1515	Contact Factory	
30" x 48"	Rectangle	IDD1 3048RE S	1	1	24"	4	round base	1020	1195	1555	1725	Contact Factory	
30" x 48"	Rectangle	IDQ1 3048RE S	1	1	18"	4	square base	1150	1215	1470	1760	Contact Factory	
30" x 60"	Rectangle	IDD1 3060RE S	1	2	18"	4	round base	1595	1810	2290	2530	Contact Factory	
30" x 60"	Rectangle	IDQ1 3060RE S	1	2	18"	4	square base	2000	2075	2415	2780	Contact Factory	
30" x 72"	Rectangle	IDD1 3072RE S	1	2	18"	4	round base	1640	1900	2440	2705	Contact Factory	
30" x 72"	Rectangle	IDQ1 3072RE S	1	2	18"	4	square base	2080	2165	2590	3040	Contact Factory	
30" x 84"	Rectangle	IDD1 3084RE S	1	2	18"	4	round base	1740	1980	2580	2875	Contact Factory	
30" x 84"	Rectangle	IDQ1 3084RE S	1	2	18"	4	square base	2105	2195	2935	3520	Contact Factory	
30" x 96"	Rectangle	IDD1 3096RE S	1	2	18"	4	round base	1750	2065	2725	3050	Contact Factory	
30" x 96"	Rectangle	IDQ1 3096RE S	1	2	18"	4	square base	2115	2215	2940	3540	Contact Factory	
30" x 120"	Rectangle	IDD1 30120RE S	1	2	18"	4	round base	2060	2180	2910	3860	Contact Factory	
30" x 120"	Rectangle	IDQ1 30120RE S	1	2	18"	4	square base	2240	2360	3090	4040	Contact Factory	
36" x 48"	Rectangle	IDD1 3648RE S	1	1	28"	4	round base	1315	1455	1885	2090	Contact Factory	
36" x 48"	Rectangle	IDQ1 3648RE S	1	1	18"x28"	6	square base	1510	1580	1895	2245	Contact Factory	
36" x 60"	Rectangle	IDD1 3660RE S	1	2	18"	4	round base	1920	2090	2650	2925	Contact Factory	
36" x 60"	Rectangle	IDQ1 3660RE S	1	2	18"	4	square base	2090	2170	2590	3025	Contact Factory	
36" x 72"	Rectangle	IDD1 3672RE S	1	2	18"	4	round base	1990	2190	2820	3135	Contact Factory	
36" x 72"	Rectangle	IDQ1 3672RE S	1	2	18"	4	square base	2180	2275	2900	3335	Contact Factory	
36" x 84"	Rectangle	IDD1 3684RE S	1	2	18"	4	round base	2140	2285	2985	3735	Contact Factory	
36" x 84"	Rectangle	IDQ1 3684RE S	1	2	18"	4	square base	2390	2515	3210	3915	Contact Factory	
36" x 96"	Rectangle	IDD1 3696RE S	1	2	18"	4	round base	2155	2385	3165	3545	Contact Factory	
36" x 96"	Rectangle	IDQ1 3696RE S	1	2	18"	4	square base	2400	2530	3235	3940	Contact Factory	
36" x 120"	Rectangle	IDD1 36120RE S	1	2	18"	4	round base	2405	2565	3600	4375	Contact Factory	
36" x 120"	Rectangle	IDQ1 36120RE S	1	2	18"	4	square base	2585	2745	3780	4555	Contact Factory	

BASE OPTIONS: [page 45 for base heights]

- Add Levelers – Raises base 1" off of the floor
- Bar Height on round bases (overall table height is 42")
- Bar Height on square bases (overall table height is 42")
- Café Height on round bases (overall table height is 36")
- Café Height on square bases (overall table height is 36")
- Alternate table height shorter than 29"
- Alternate table height taller than 29"
- Adjustable height (spring clip)
- Polished Chrome on 18" and 24" round bases
- Self-adjustable glides on base
- Metal to Metal threaded inserts. Factory Installed.

MODEL CODE

LIST PRICE

- LV \$80 per table
- BH \$90 per table
- BH \$150 per table
- CH \$90 per table
- CH \$150 per table
- SC \$90 per table
- TC \$130 per table
- AH \$280 per table
- CR \$225 per table
- SAGS \$100 per base
- TI \$100 per table

TABLE OPTIONS:

- Add Radius Corners to table top. (Specify 1", 2", 3", 4", or 5" radius)
- Custom Stain for wood edges and veneers
- Premium Laminate
- Premium Edge-banding

- RC \$100 per table
- UCS \$600 per color
- UCL Contact Factory
- UCE Contact Factory

POWER & A/V OPTIONS: [page 21- 38]

- Non-powered round ABS plastic Grommet (black or silver) | List location code on page 18
- Non-powered rectangle metal Grommet (black or silver) | List location code on page 18

- G (B/S) \$20 per grommet
- GV (B/S) \$120 per grommet

PINNACLE

COLLECTION

Pinnacle Options

Below are options that are available on all Pinnacle tables.

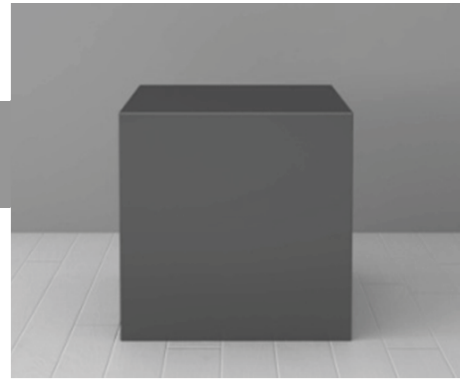

TABLE OPTIONS:

- Custom Stain
- Premium laminate upcharge
- Match toe kick to table laminate
- Match toe kick to table veneer

POWER & A/V OPTIONS : [page 21- 38]

- Non-powered round ABS plastic Grommet (black or silver) | List location code on page 18
- Non-powered rectangle metal Grommet (black or silver) | List location code on page 18

ACCESSORIES: [page 46-47 for misc. options]

- Add 4" Radius Corners to Square / Rectangle Laminate Tables
- Add 4" Radius Corners to Square / Rectangle Veneer Tables

MODEL CODE

- UCS
- UCL
- ML
- MW

LIST PRICE

- \$600 per color
- \$100
- \$200

- G (B/S)
- GV (B/S)

- \$20 per grommet
- \$120 per grommet

- RC
- RC

- \$715 per laminate table
- \$775 per veneer table

Contact Factory FOR LAYOUT, SIZE OPTIONS AND SPECIFICATION ASSISTANCE

Example Base Product Code :						Finish Selections:		
<u>CN</u>	<u>CL</u>	<u>3060</u>	<u>RE</u>	<u>S</u>	<u>L3</u>	-	Options in	<u>BK</u>
Product	Base	Top	Top	Table	Top		Alphabetical Order	Base
Line	style	size	shape	function	edge			Finish
								<u>7909-60</u>
								Top Laminate or
								Veneer Selection
								<u>BK</u>
								Edge
								Color



RECTANGLE TABLE
 Shown with Toe Kick

Toe Kick:
 Add -TK to end of model code to add the toe kick
 Contact Factory for Veneer tables

RECTANGLE TABLES				
Table Size	Base Material	Model Code:	With Out Toe Kick	With 2" Toe Kick
12 x 48 x 18"h	HPL	OR1248-18H.L	2535	3070
12 x 48 x 18"h	Veneer	OR1248-18H.W	4745	5325
12 x 48 x 24"h	HPL	OR1248-24H.L	2670	3205
12 x 48 x 24"h	Veneer	OR1248-24H.W	5060	5640
12 x 48 x 30"h	HPL	OR1248-30H.L	3415	3950
12 x 48 x 30"h	Veneer	OR1248-30H.W	5905	6485
18 x 30 x 18h	HPL	OR1830-18H.L	2335	2775
18 x 30 x 18h	Veneer	OR1830-18H.W	4475	4955
18 x 36 x 18h	HPL	OR1836-18H.L	1915	2445
18 x 36 x 18h	Veneer	OR1836-18H.W	5020	5595
18 x 48 x 18h	HPL	OR1848-18H.L	2955	3595
18 x 48 x 18h	Veneer	OR1848-18H.W	5295	5985
18 x 60 x 18h	HPL	OR1860-18H.L	3950	4725
18 x 60 x 18h	Veneer	OR1860-18H.W	6515	7355
18 x 30 x 24h	HPL	OR1830-24H.L	2600	3040
18 x 30 x 24h	Veneer	OR1830-24H.W	5100	5580
18 x 36 x 24h	HPL	OR1836-24H.L	2820	3350
18 x 36 x 24h	Veneer	OR1836-24H.W	5685	6260
18 x 48 x 24h	HPL	OR1848-24H.L	3380	4020
18 x 48 x 24h	Veneer	OR1848-24H.W	5835	6525
18 x 60 x 24h	HPL	OR1860-24H.L	4050	4825
18 x 60 x 24h	Veneer	OR1860-24H.W	7085	7925
18 x 30 x 30h	HPL	OR1830-30H.L	2745	3185
18 x 30 x 30h	Veneer	OR1830-30H.W	5360	5840
18 x 36 x 30h	HPL	OR1836-30H.L	3000	3530
18 x 36 x 30h	Veneer	OR1836-30H.W	5980	6555
18 x 48 x 30h	HPL	OR1848-30H.L	3855	4495
18 x 48 x 30h	Veneer	OR1848-30H.W	6150	6840
18 x 60 x 30h	HPL	OR1860-30H.L	4320	5095
18 x 60 x 30h	Veneer	OR1860-30H.W	7510	8350

RECTANGLE TABLES				
Table Size	Base Material	Model Code:	With Out Toe Kick	With 2" Toe Kick
24 x 36 x 18h	HPL	OR2436-18H.L	2505	3095
24 x 36 x 18h	Veneer	OR2436-18H.W	4805	5445
24 x 48 x 18h	HPL	OR2448-18H.L	3045	3790
24 x 48 x 18h	Veneer	OR2448-18H.W	5575	6385
24 x 60 x 18h	HPL	OR2460-18H.L	4070	4970
24 x 60 x 18h	Veneer	OR2460-18H.W	6335	7310
24 x 36 x 24h	HPL	OR2436-24H.L	3375	3965
24 x 36 x 24h	Veneer	OR2436-24H.W	6020	6660
24 x 48 x 24h	HPL	OR2448-24H.L	3925	4670
24 x 48 x 24h	Veneer	OR2448-24H.W	6195	7005
24 x 60 x 24h	HPL	OR2460-24H.L	4250	5150
24 x 60 x 24h	Veneer	OR2460-24H.W	7665	8640
24 x 36 x 30h	HPL	OR2436-30H.L	3855	4445
24 x 36 x 30h	Veneer	OR2436-30H.W	6465	7105
24 x 48 x 30h	HPL	OR2448-30H.L	4240	4985
24 x 48 x 30h	Veneer	OR2448-30H.W	6705	7515
24 x 60 x 30h	HPL	OR2460-30H.L	4590	5490
24 x 60 x 30h	Veneer	OR2460-30H.W	8015	8990
30 x 48 x 18h	HPL	OR3048-18H.L	4200	5035
30 x 48 x 18h	Veneer	OR3048-18H.W	6770	7675
30 x 60 x 18h	HPL	OR3060-18H.L	4640	5650
30 x 60 x 18h	Veneer	OR3060-18H.W	7925	9020
30 x 48 x 24h	HPL	OR3048-24H.L	4275	5110
30 x 48 x 24h	Veneer	OR3048-24H.W	6465	7370
30 x 60 x 24h	HPL	OR3060-24H.L	4755	5765
30 x 60 x 24h	Veneer	OR3060-24H.W	6705	8000
30 x 48 x 30h	HPL	OR3048-30H.L	4735	5570
30 x 48 x 30h	Veneer	OR3048-30H.W	7365	8270
30 x 60 x 30h	HPL	OR3060-30H.L	6200	7210
30 x 60 x 30h	Veneer	OR3060-30H.W	9350	10,445
36 x 48 x 18"h	HPL	OR3648-18H.L	4470	5325
36 x 48 x 18"h	Veneer	OR3648-18H.W	7005	7930
36 x 48 x 24"h	HPL	OR3648-24H.L	4675	5530
36 x 48 x 24"h	Veneer	OR3648-24H.W	7495	8420
36 x 48 x 30"h	HPL	OR3648-30H.L	5005	5860
36 x 48 x 30"h	Veneer	OR3648-30H.W	7875	8800
48 x 60 x 18"h	HPL	OR4860-18H.L	5070	6100
48 x 60 x 18"h	Veneer	OR4860-18H.W	8425	9540
48 x 60 x 24"h	HPL	OR4860-24H.L	5526	6556
48 x 60 x 24"h	Veneer	OR4860-24H.W	9100	10,215
48 x 60 x 30"h	HPL	OR4860-30H.L	6520	7550
48 x 60 x 30"h	Veneer	OR4860-30H.W	9640	10,755



Toe Kick:
Add -TK to end of model code to add the toe kick



ROUND TABLE
With Out Toe Kick



ROUND TABLE
With Toe Kick



SQUARE TABLE
With Out Toe Kick



SQUARE TABLE
With Toe Kick

ROUND TABLES

Table Size	Base Material	Model Code:	With Out Toe Kick	With 2" Toe Kick
18 x 18h	HPL	OC18-18H.L	1245	1625
18 x 18h	Veneer	OC18-18H.W	3155	3565
18 x 24h	HPL	OC18-24H.L	1275	1655
18 x 24h	Veneer	OC18-24H.W	3335	3745
18 x 30h	HPL	OC18-30H.L	1375	1755
18 x 30h	Veneer	OC18-30H.W	3505	3915
24 x 18h	HPL	OC24-18H.L	1420	1890
24 x 18h	Veneer	OC24-18H.W	3540	4050
24 x 24h	HPL	OC24-24H.L	1495	1965
24 x 24h	Veneer	OC24-24H.W	3935	4445
24 x 30h	HPL	OC24-30H.L	1840	2310
24 x 30h	Veneer	OC24-30H.W	4070	4580
30 x 18h	HPL	OC30-18H.L	1700	2085
30 x 18h	Veneer	OC30-18H.W	4060	4685
30 x 24h	HPL	OC30-24H.L	1780	2360
30 x 24h	Veneer	OC30-24H.W	4210	4835
30 x 30h	HPL	OC30-30H.L	2205	2785
30 x 30h	Veneer	OC30-30H.W	4355	4980
36 x 18h	HPL	OC36-18H.L	2445	3145
36 x 18h	Veneer	OC36-18H.W	4740	5495
36 x 24h	HPL	OC36-24H.L	2570	3270
36 x 24h	Veneer	OC36-24H.W	5045	5800
36 x 30h	HPL	OC36-30H.L	2910	3610
36 x 30h	Veneer	OC36-30H.W	5385	6140

SQUARE TABLES

Table Size	Base Material	Model Code:	With Out Toe Kick	With 2" Toe Kick
18 x 18h	HPL	OS18-18H.L	1350	1790
18 x 18h	Veneer	OS18-18H.W	3330	3805
18 x 24h	HPL	OS18-24H.L	1410	1850
18 x 24h	Veneer	OS18-24H.W	3530	4005
18 x 30h	HPL	OS18-30H.L	1740	2180
18 x 30h	Veneer	OS18-30H.W	3995	4470
24 x 18h	HPL	OS24-18H.L	1720	2220
24 x 18h	Veneer	OS24-18H.W	3980	4520
24 x 24h	HPL	OS24-24H.L	1735	2235
24 x 24h	Veneer	OS24-24H.W	4130	4670
24 x 30h	HPL	OS24-30H.L	1875	2375
24 x 30h	Veneer	OS24-30H.W	4285	4825
30 x 18h	HPL	OS30-18H.L	1880	2535
30 x 18h	Veneer	OS30-18H.W	4525	5235
30 x 24h	HPL	OS30-24H.L	1960	2615
30 x 24h	Veneer	OS30-24H.W	5195	5905
30 x 30h	HPL	OS30-30H.L	2250	2905
30 x 30h	Veneer	OS30-30H.W	5360	6070
36 x 18h	HPL	OS36-18H.L	2450	3105
36 x 18h	Veneer	OS36-18H.W	5150	6030
36 x 24h	HPL	OS36-24H.L	2875	3530
36 x 24h	Veneer	OS36-24H.W	5545	6425
36 x 30h	HPL	OS36-30H.L	3045	3700
36 x 30h	Veneer	OS36-30H.W	6140	7020

Railway Options

Below are options that are available on all Railway tables.

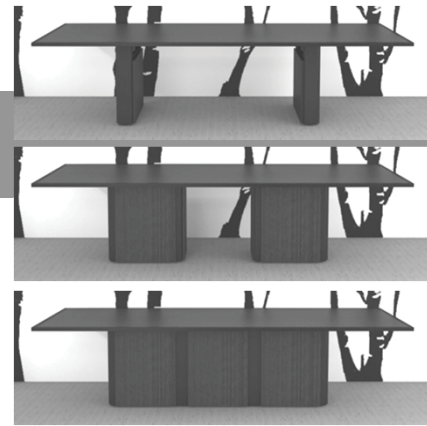

TABLE OPTIONS

Custom Stain for wood edges and veneers
 Premium Laminate
 Premium Edge-banding

UCS	\$600 per color
UCL	Contact Factory
UCE	Contact Factory

POWER & A/V OPTIONS : [page 21- 38]

Non-powered round ABS plastic Grommet (black or silver) | List location code on page 18
 Non-powered rectangle metal Grommet (black or silver) | List location code on page 18

G (B/S)	\$20 per grommet
GV (B/S)	\$120 per grommet

WIRE MANAGEMENT: [page 40 - 42]

Customer specified hole cut into top
 36" long Horizontal 4 track Extruded Raceway
 Horizontal conference Wire Management Trough

CNC	\$250 set up fee per template
WH	\$80 per piece
WT	\$475 per table

ACCESSORIES: [pages 39 - 49 for options]

Make 120"long (or shorter) tables into two pieces
 Flat Plates
 Add Radius Corners to table top. (Specify 1", 2", 3", 4", or 5" radius)

FJ	\$300 per table
FP	\$20 per plate
RC	\$100 per table

Contact Factory FOR LAYOUT, SIZE OPTIONS AND SPECIFICATION ASSISTANCE

Example Base Product Code :						Finish Selections:				
<u>RY</u>	<u>CL</u>	<u>3060</u>	<u>RE</u>	<u>S</u>	<u>L3</u>	-	Options in	<u>BK</u>	<u>7909-60</u>	<u>BK</u>
Product	Base	Top	Top	Table	Top		Alphabetical	Base	Top Laminate or	Edge
Line	style	size	shape	function	edge		Order	Finish	Veneer Selection	Color



Table Size	Table Shape	Base Material	Base Shape	Model Code:	Top QTY	Base Size	
36 x 84 x 29	D-top	HPL	Rectangle	RYRL368429DS S.L3	1	18x48x29	\$5560
36 x 84 x 36	D-top	HPL	Rectangle	RYRL368436DS S.L3	1	18x48x36	\$5990
36 x 84 x 42	D-top	HPL	Rectangle	RYRL368442DS S.L3	1	18x48x42	\$6355
42 x 72 x 29	D-top	HPL	Rectangle	RYRL427229DS S.L3	1	18x24x29	\$4050
42 x 72 x 36	D-top	HPL	Rectangle	RYRL427236DS S.L3	1	18x24x36	\$4095
42 x 72 x 42	D-top	HPL	Rectangle	RYRL427242DS S.L3	1	18x24x42	\$4450
48 x 120 x 29	D-top	HPL	Rectangle	RYRL4812029DS S.L3	1	18x72x29	\$7645
48 x 120 x 36	D-top	HPL	Rectangle	RYRL4812036DS S.L3	1	18x72x36	\$7960
48 x 120 x 42	D-top	HPL	Rectangle	RYRL4812042DS S.L3	1	18x72x42	\$8445
60 x 66 x 29	D-top	HPL	Rectangle	RYRL606629DS S.L3	1	24x30x29	\$4205
60 x 66 x 36	D-top	HPL	Rectangle	RYRL606636DS S.L3	1	24x30x36	\$4405
60 x 66 x 42	D-top	HPL	Rectangle	RYRL606642DS S.L3	1	24x30x42	\$4640

Laminate

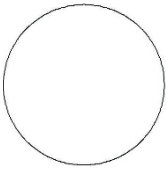
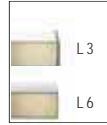

Cube Base

Laminate & FormaWrap Tables



Table Size	Table Shape	Base Material	Base Shape	Model Code:	Top QTY	Base QTY	Base Size					
42"	round	HPL	cube	RYCL42RDS	1	1	18"	3045	3160	3835	3980	Contact Factory
48"	round	HPL	cube	RYCL48RDS	1	1	18"	3055	3165	4110	4295	Contact Factory
54"	round	HPL	cube	RYCL54RDS	1	1	24"	3350	3485	4775	5010	Contact Factory
60"	round	HPL	cube	RYCL60RDS	1	1	24"	3365	3490	5085	5380	Contact Factory
72"	round	HPL	cube	RYCL72RDS	2	1	30"	4405	4650	6545	6945	Contact Factory
24"	square	HPL	cube	RYCL24SQS	1	1	18"	2855	2905	2915	2965	Contact Factory
30"	square	HPL	cube	RYCL30SQS	1	1	18"	2915	2970	3095	3185	Contact Factory
36"	square	HPL	cube	RYCL36SQS	1	1	18"	2975	3035	3195	3460	Contact Factory
42"	square	HPL	cube	RYCL42SQS	1	1	18"	2995	3065	3445	3890	Contact Factory
48"	square	HPL	cube	RYCL48SQS	1	1	24"	3115	3190	3795	4260	Contact Factory
54"	square	HPL	cube	RYCL54SQS	1	1	30"	3415	3510	4580	5305	Contact Factory
60"	square	HPL	cube	RYCL60SQS	1	1	30"	3420	3520	4585	5310	Contact Factory

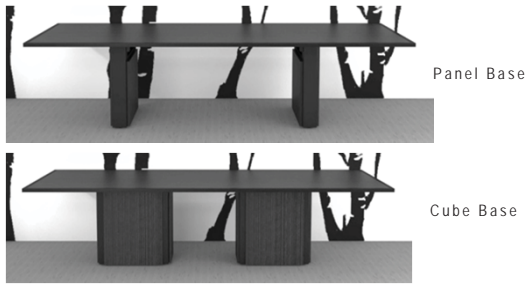

Laminate & FormaWrap Tables



Table Size	Top Shape	Base Material	Base Shape	Base Model Code:	Top QTY	Base QTY	Base Size						
36" x 72"	rectangle	HPL	cube	RYCL3672RES	1	2	18"	5570	5865	6390	6925	Contact	Factory
36" x 72"	rectangle	HPL	panel	RYPL3672RES	1	2	18"	3060	3155	3680	4215	Contact	Factory
36" x 72"	racetrack	HPL	cube	RYCL3672RTS	1	2	18"	5770	5865	6780	1775	Contact	Factory
36" x 72"	racetrack	HPL	panel	RYPL3672RTS	1	2	18"	3060	6155	4070	4465	Contact	Factory
36" x 84"	rectangle	HPL	cube	RYCL3684RES	1	2	18"	5980	6105	6800	7505	Contact	Factory
36" x 84"	rectangle	HPL	panel	RYPL3684RES	1	2	18"	3325	3450	4145	4850	Contact	Factory
36" x 84"	racetrack	HPL	cube	RYCL3684RTS	1	2	18"	5980	6105	7200	7755	Contact	Factory
36" x 84"	racetrack	HPL	panel	RYPL3684RTS	1	2	18"	3325	3450	4545	5100	Contact	Factory
36" x 96"	rectangle	HPL	cube	RYCL3696RES	1	2	18"	5990	6120	6825	7530	Contact	Factory
36" x 96"	rectangle	HPL	panel	RYPL3696RES	1	2	18"	3390	3520	4225	4930	Contact	Factory
36" x 96"	racetrack	HPL	cube	RYCL3696RTS	1	2	18"	5990	6120	7220	7765	Contact	Factory
36" x 96"	racetrack	HPL	panel	RYPL3696RTS	1	2	18"	3390	3520	4620	5165	Contact	Factory
36" x 108"	rectangle	HPL	cube	RYCL36108RES	1	2	18"	6175	6335	7370	8145	Contact	Factory
36" x 108"	rectangle	HPL	panel	RYPL36108RES	1	2	18"	3630	3790	4825	5600	Contact	Factory
36" x 108"	racetrack	HPL	cube	RYCL36108RTS	1	2	18"	6175	6335	7815	8395	Contact	Factory
36" x 108"	racetrack	HPL	panel	RYPL36108RTS	1	2	18"	3630	3790	5270	5850	Contact	Factory
36" x 120"	rectangle	HPL	cube	RYCL36120RES	1	2	18"	6175	6335	7370	8145	Contact	Factory
36" x 120"	rectangle	HPL	panel	RYPL36120RES	1	2	18"	3685	3845	4880	5655	Contact	Factory
36" x 120"	racetrack	HPL	cube	RYCL36120RTS	1	2	18"	6175	6335	7815	8395	Contact	Factory
36" x 120"	racetrack	HPL	panel	RYPL36120RTS	1	2	18"	3685	3845	5325	5905	Contact	Factory

TABLE OPTIONS

Custom Stain for wood edges and veneers	UCS	\$600 per color
Premium Laminate	UCL	Contact Factory
Premium Edge-banding	UCE	Contact Factory

POWER & AV OPTIONS : [page 21- 38]

Non-powered round ABS plastic Grommet (black or silver) List location code on page 18	G (B/S)	\$20 per grommet
Non-powered rectangle metal Grommet (black or silver) List location code on page 18	GV (B/S)	\$120 per grommet

WIRE MANAGEMENT: [page 40 - 42]

Customer specified hole cut into top	CNC	\$250 set up fee per template
36" long Horizontal 4 track Extruded Raceway	WH	\$80 per piece
Horizontal conference Wire Management Trough	WT	\$475 per table

ACCESSORIES: [pages 39 - 49 for options]

Make 120"long (or shorter) tables into two pieces	FJ	\$300 per table
Flat Plates	FP	\$20 per plate
Add Radius Corners to table top. (Specify 1", 2", 3", 4", or 5" radius)	RC	\$100 per table

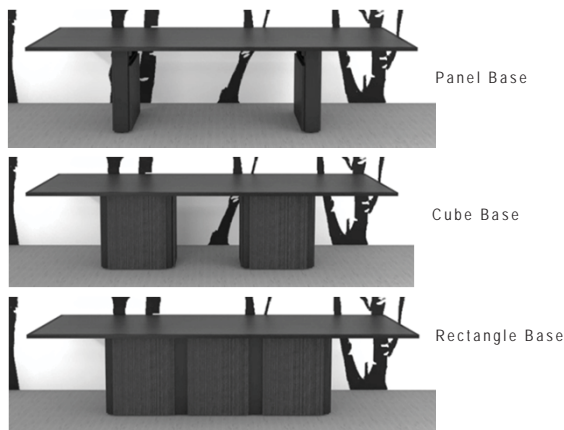

Laminate & FormaWrap Tables

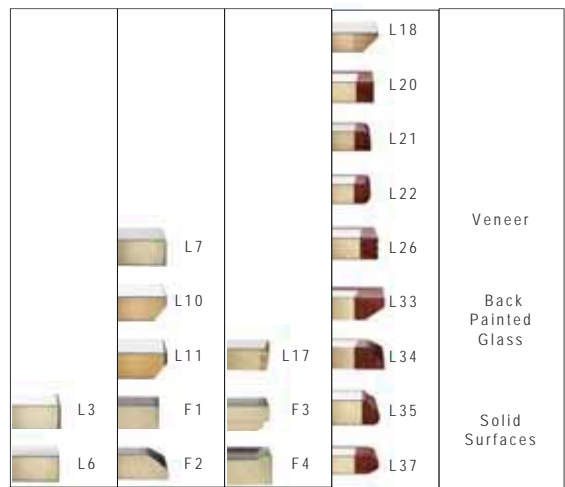

Table Size	Top Shape	Base Material	Base Shape	Model Code:	Top QTY	Base QTY	Base Size					
48" x 72"	rectangle	HPL	cube	RYCL4872RES	1	2	18"	5780	5880	6855	7445	Contact Factory
48" x 72"	rectangle	HPL	panel	RYPL4872RES	1	2	24"	3205	3305	4280	4970	Contact Factory
48" x 72"	racetrack	HPL	cube	RYCL4872RTS	1	2	18"	5870	5980	7145	7795	Contact Factory
48" x 72"	racetrack	HPL	panel	RYPL4872RTS	1	2	24"	3295	3405	4570	5220	Contact Factory
48" x 72"	boat-shape	HPL	cube	RYCL4872BTS	1	2	18"	5870	5980	7145	7795	Contact Factory
48" x 72"	boat-shape	HPL	panel	RYPL4872BTS	1	2	24"	3295	3405	4570	5220	Contact Factory
48" x 84"	rectangle	HPL	cube	RYCL4884RES	1	2	18"	5990	6120	7425	8350	Contact Factory
48" x 84"	rectangle	HPL	panel	RYPL4884RES	1	2	24"	3470	3600	4905	5830	Contact Factory
48" x 84"	racetrack	HPL	cube	RYCL4884RTS	1	2	18"	6075	6215	7730	8850	Contact Factory
48" x 84"	racetrack	HPL	panel	RYPL4884RTS	1	2	24"	3555	3695	5210	6330	Contact Factory
48" x 84"	boat-shape	HPL	cube	RYCL4884BTS	1	2	18"	6075	6215	7730	8850	Contact Factory
48" x 84"	boat-shape	HPL	panel	RYPL4884BTS	1	2	24"	3555	3695	5210	6330	Contact Factory
48" x 96"	rectangle	HPL	cube	RYCL4896RES	1	2	18"	6055	6140	7430	8360	Contact Factory
48" x 96"	rectangle	HPL	panel	RYPL4896RES	1	2	24"	3540	3675	4965	5895	Contact Factory
48" x 96"	rectangle	HPL	rectangle	RYRL4896RES	1	1	18" x 50"	5565	5700	6990	7920	Contact Factory
48" x 96"	racetrack	HPL	cube	RYCL4896RTS	1	2	18"	6080	6225	7740	8860	Contact Factory
48" x 96"	racetrack	HPL	panel	RYPL4896RTS	1	2	24"	3615	3760	5275	6395	Contact Factory
48" x 96"	racetrack	HPL	rectangle	RYRL4896RTS	1	1	18" x 50"	5640	5785	7300	8420	Contact Factory
48" x 96"	boat-shape	HPL	cube	RYCL4896BTS	1	2	18"	6080	6225	7740	8860	Contact Factory
48" x 96"	boat-shape	HPL	panel	RYPL4896BTS	1	2	24"	3615	3760	5275	6395	Contact Factory
48" x 96"	boat-shape	HPL	rectangle	RYRL4896BTS	1	1	18" x 50"	5640	5785	7300	8420	Contact Factory
48" x 108"	rectangle	HPL	cube	RYCL48108RES	1	2	18"	1675	6335	8120	9150	Contact Factory
48" x 108"	rectangle	HPL	panel	RYPL48108RES	1	2	24"	3765	3925	5710	6740	Contact Factory
48" x 108"	rectangle	HPL	rectangle	RYRL48108RES	1	1	18" x 75"	7825	7985	9770	10,800	Contact Factory
48" x 108"	racetrack	HPL	cube	RYCL48108RTS	1	2	18"	6260	6430	8565	9650	Contact Factory
48" x 108"	racetrack	HPL	panel	RYPL48108RTS	1	2	24"	3850	4020	6155	7240	Contact Factory
48" x 108"	racetrack	HPL	rectangle	RYRL48108RTS	1	1	18" x 75"	7910	8080	10,215	11,300	Contact Factory
48" x 108"	boat-shape	HPL	cube	RYCL48108BTS	1	2	18"	6260	6430	8565	9650	Contact Factory
48" x 108"	boat-shape	HPL	panel	RYPL48108BTS	1	2	24"	3850	4020	6155	7240	Contact Factory
48" x 108"	boat-shape	HPL	rectangle	RYRL48108BTS	1	1	18" x 75"	7910	8080	10,215	11,300	Contact Factory
48" x 120"	rectangle	HPL	cube	RYCL48120RES	1	2	18"	6190	6350	8130	9160	Contact Factory
48" x 120"	rectangle	HPL	panel	RYPL48120RES	1	2	24"	3835	3995	5775	6805	Contact Factory
48" x 120"	rectangle	HPL	rectangle	RYRL48120RES	1	1	18" x 75"	7840	8000	9780	10,810	Contact Factory
48" x 120"	racetrack	HPL	cube	RYCL48120RTS	1	2	18"	6260	6430	8565	9650	Contact Factory
48" x 120"	racetrack	HPL	panel	RYPL48120RTS	1	2	24"	3915	4085	6215	7315	Contact Factory
48" x 120"	racetrack	HPL	rectangle	RYRL48120RTS	1	1	18" x 75"	7920	8090	10,220	11,320	Contact Factory
48" x 120"	boat-shape	HPL	cube	RYCL48120BTS	1	2	18"	6260	6430	8565	9650	Contact Factory
48" x 120"	boat-shape	HPL	panel	RYPL48120BTS	1	2	24"	3915	4085	6215	7315	Contact Factory
48" x 120"	boat-shape	HPL	rectangle	RYRL48120BTS	1	1	18" x 75"	7920	8090	10,220	11,320	Contact Factory

TABLE OPTIONS

Custom Stain for wood edges and veneers	UCS	\$600 per color
Premium Laminate	UCL	Contact Factory
Premium Edge-banding	UCE	Contact Factory

POWER & AV OPTIONS : [page 21- 38]

Non-powered round ABS plastic Grommet (black or silver) List location code on page 18	G (B/S)	\$20 per grommet
Non-powered rectangle metal Grommet (black or silver) List location code on page 18	GV (B/S)	\$120 per grommet

WIRE MANAGEMENT: [page 40 - 42]

Customer specified hole cut into top	CNC	\$250 set up fee per template
36" long Horizontal 4 track Extruded Raceway	WH	\$80 per piece
Horizontal conference Wire Management Trough	WT	\$475 per table

ACCESSORIES: [pages 39 - 49 for options]

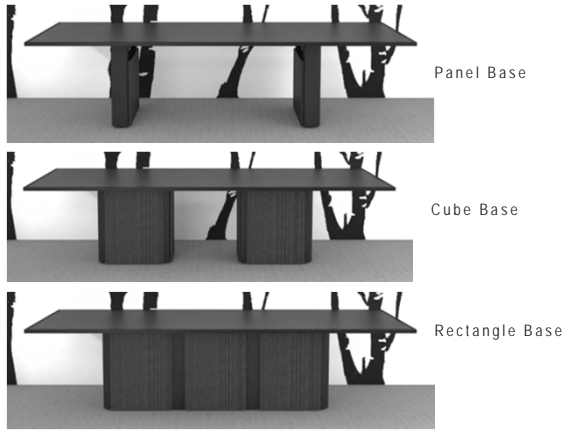

Laminate & FormaWrap Tables

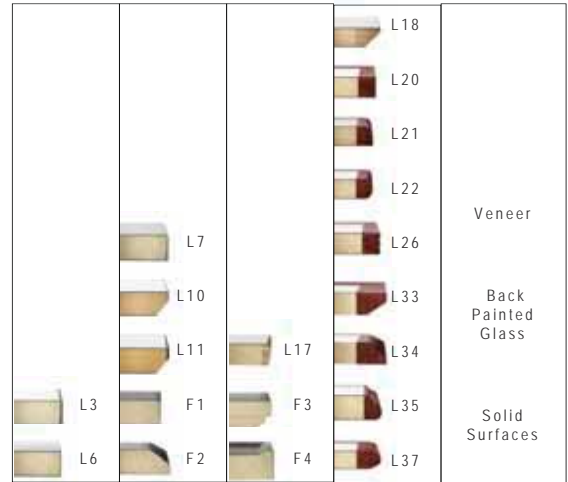

Table Size	Top Shape	Base Material	Base Shape	Model Code:	Top QTY	Base QTY	Base Size					
48" x 144"	rectangle	HPL	cube	RYCL48144RES	2	3	18"	8940	9125	11,275	12,445	Contact Factory
48" x 144"	rectangle	HPL	panel	RYPL48144RES	2	3	24"	5320	5490	7640	8910	Contact Factory
48" x 144"	rectangle	HPL	rectangle	RYRL48144RES	2	1	18" x 100"	10,115	10,300	12,450	13,720	Contact Factory
48" x 144"	racetrack	HPL	cube	RYCL48144RTS	2	3	18"	9025	9220	11,735	13,045	Contact Factory
48" x 144"	racetrack	HPL	panel	RYPL48144RTS	2	3	24"	5390	5585	8100	9410	Contact Factory
48" x 144"	racetrack	HPL	rectangle	RYRL48144RTS	2	1	18" x 100"	10,200	10,395	12,910	14,220	Contact Factory
48" x 144"	boat-shape	HPL	cube	RYCL48144BTS	2	3	18"	9025	9220	11,735	13,405	Contact Factory
48" x 144"	boat-shape	HPL	panel	RYPL48144BTS	2	3	24"	5390	5585	8100	9410	Contact Factory
48" x 144"	boat-shape	HPL	rectangle	RYRL48144BTS	2	1	18" x 100"	10,200	10,395	12,910	14,220	Contact Factory
48" x 168"	rectangle	HPL	cube	RYCL48168RES	2	3	18"	9595	9880	11,875	13,325	Contact Factory
48" x 168"	rectangle	HPL	panel	RYPL48168RES	2	3	24"	6070	6355	8350	9800	Contact Factory
48" x 168"	rectangle	HPL	rectangle	RYRL48168RES	2	1	18" x 125"	12,860	13,145	15,140	16,590	Contact Factory
48" x 168"	racetrack	HPL	cube	RYCL48168RTS	2	3	18"	9640	9725	12,325	13,830	Contact Factory
48" x 168"	racetrack	HPL	panel	RYPL48168RTS	2	3	24"	6115	6200	8800	10,305	Contact Factory
48" x 168"	racetrack	HPL	rectangle	RYRL48168RTS	2	1	18" x 125"	12,905	12,990	15,590	17,095	Contact Factory
48" x 168"	boat-shape	HPL	cube	RYCL48168BTS	2	3	18"	9640	9725	12325	13,830	Contact Factory
48" x 168"	boat-shape	HPL	panel	RYPL48168BTS	2	3	24"	6115	6200	8800	10,305	Contact Factory
48" x 168"	boat-shape	HPL	rectangle	RYRL48168BTS	2	1	18" x 125"	12,905	12,990	15,590	17,095	Contact Factory
48" x 192"	rectangle	HPL	cube	RYCL48192RES	2	3	18"	9625	9915	12,470	14,130	Contact Factory
48" x 192"	rectangle	HPL	panel	RYPL48192RES	2	3	24"	6210	6500	9055	10,715	Contact Factory
48" x 192"	rectangle	HPL	rectangle	RYRL48192RES	2	1	18" x 150"	14,980	15,270	17,825	19,485	Contact Factory
48" x 192"	racetrack	HPL	cube	RYCL48192RTS	2	3	18"	9640	9725	12,325	13,830	Contact Factory
48" x 192"	racetrack	HPL	panel	RYPL48192RTS	2	3	24"	6115	6200	8800	10,305	Contact Factory
48" x 192"	racetrack	HPL	rectangle	RYRL48192RTS	2	1	18" x 150"	12,905	12,990	15,590	17,095	Contact Factory
48" x 192"	boat-shape	HPL	cube	RYCL48192BTS	2	3	18"	9640	9725	12,325	13,830	Contact Factory
48" x 192"	boat-shape	HPL	panel	RYPL48192BTS	2	3	24"	6115	6200	8800	10,305	Contact Factory
48" x 192"	boat-shape	HPL	rectangle	RYRL48192BTS	2	1	18" x 150"	12,905	12,990	15,590	17,095	Contact Factory
48" x 228"	rectangle	HPL	cube	RYCL48228RES	2	4	18"	12,620	12,970	16,225	18,410	Contact Factory
48" x 228"	rectangle	HPL	panel	RYPL48228RES	2	4	24"	8040	8390	11,645	13,830	Contact Factory
48" x 228"	rectangle	HPL	rectangle	RYRL48228RES	2	1	18" x 175"	19,590	19,940	23,195	25,380	Contact Factory
48" x 228"	racetrack	HPL	cube	RYCL48228RTS	2	4	18"	12,635	12,990	16,710	18,820	Contact Factory
48" x 228"	racetrack	HPL	panel	RYPL48228RTS	2	4	24"	8055	8410	12,130	14,240	Contact Factory
48" x 228"	racetrack	HPL	rectangle	RYRL48228RTS	2	1	18" x 175"	19,605	19,960	23,195	25,380	Contact Factory
48" x 228"	boat-shape	HPL	cube	RYCL48228BTS	2	4	18"	12,635	12,990	16,710	18,820	Contact Factory
48" x 228"	boat-shape	HPL	panel	RYPL48228BTS	2	4	24"	8055	8410	12,130	14,240	Contact Factory
48" x 228"	boat-shape	HPL	rectangle	RYRL48228BTS	2	1	18" x 175"	19,605	19,960	23,195	25,380	Contact Factory

TABLE OPTIONS

Custom Stain for wood edges and veneers	UCS	\$600 per color
Premium Laminate	UCL	Contact Factory
Premium Edge-banding	UCE	Contact Factory

POWER & AV OPTIONS : [page 21- 38]

Non-powered round ABS plastic Grommet (black or silver) List location code on page 18	G (B/S)	\$20 per grommet
Non-powered rectangle metal Grommet (black or silver) List location code on page 18	GV (B/S)	\$120 per grommet

WIRE MANAGEMENT: [page 40 - 42]

Customer specified hole cut into top	CNC	\$250 set up fee per template
36" long Horizontal 4 track Extruded Raceway	WH	\$80 per piece
Horizontal conference Wire Management Trough	WT	\$475 per table

ACCESSORIES: [pages 39 - 49 for options]

Laminate & FormaWrap Tables

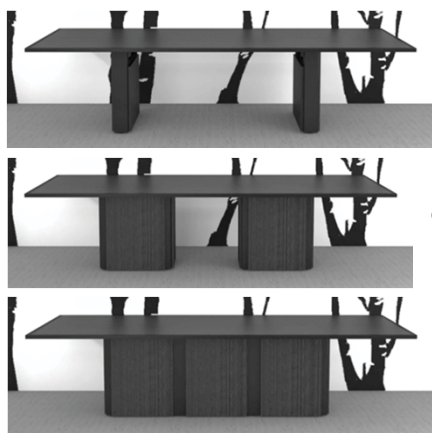

Panel Base

Cube Base

Rectangle Base



Table Size	Top Shape	Base Material	Base Shape	Base Model Code:	Top QTY	Base QTY	Base Size						
60" x 72"	rectangle	HPL	cube	RYCL6072RES	1	2	24"	6135	6255	7590	8365	Contact Factory	
60" x 72"	rectangle	HPL	panel	RYPL6072RES	1	2	30"	3470	3590	4925	5700	Contact Factory	
60" x 72"	racetrack	HPL	cube	RYCL6072RTS	1	2	24"	6215	6345	7815	8620	Contact Factory	
60" x 72"	racetrack	HPL	panel	RYPL6072RTS	1	2	30"	3550	3680	5150	5955	Contact Factory	
60" x 72"	boat-shape	HPL	cube	RYCL6072BTS	1	2	24"	6215	6345	7815	8620	Contact Factory	
60" x 72"	boat-shape	HPL	panel	RYPL6072BTS	1	2	30"	3550	3680	5150	5955	Contact Factory	
60" x 84"	rectangle	HPL	cube	RYCL6084RES	1	2	24"	6380	6540	8225	9370	Contact Factory	
60" x 84"	rectangle	HPL	panel	RYPL6084RES	1	2	30"	3770	9330	5725	6760	Contact Factory	
60" x 84"	racetrack	HPL	cube	RYCL6084RTS	1	2	24"	6460	6625	8785	9870	Contact Factory	
60" x 84"	racetrack	HPL	panel	RYPL6084RTS	1	2	30"	3850	4015	6175	7260	Contact Factory	
60" x 84"	boat-shape	HPL	cube	RYCL6084BTS	1	2	24"	6460	6625	8785	9870	Contact Factory	
60" x 84"	boat-shape	HPL	panel	RYPL6084BTS	1	2	30"	3850	4015	6175	7260	Contact Factory	
60" x 96"	rectangle	HPL	cube	RYCL6096RES	1	2	24"	6395	6555	7590	9380	Contact Factory	
60" x 96"	rectangle	HPL	panel	RYPL6096RES	1	2	30"	3840	4000	5785	6825	Contact Factory	
60" x 96"	rectangle	HPL	rectangle	RYRL6096RES	1	1	24" x 50"	5790	5950	7735	8775	Contact Factory	
60" x 96"	racetrack	HPL	cube	RYCL6096RTS	1	2	24"	6465	6635	8790	9890	Contact Factory	
60" x 96"	racetrack	HPL	panel	RYPL6096RTS	1	2	30"	3910	4080	6735	7335	Contact Factory	
60" x 96"	racetrack	HPL	rectangle	RYRL6096RTS	1	1	24" x 50"	5860	6030	8185	9285	Contact Factory	
60" x 96"	boat-shape	HPL	cube	RYCL6096BTS	1	2	24"	6465	6635	8790	9890	Contact Factory	
60" x 96"	boat-shape	HPL	panel	RYPL6096BTS	1	2	30"	3910	4080	6735	7335	Contact Factory	
60" x 96"	boat-shape	HPL	rectangle	RYRL6096BTS	1	1	24" x 50"	5860	6030	8185	9285	Contact Factory	
60" x 108"	rectangle	HPL	cube	RYCL60108RES	1	2	24"	6605	6795	9080	10,375	Contact Factory	
60" x 108"	rectangle	HPL	panel	RYPL60108RES	1	2	30"	4105	4295	6580	7875	Contact Factory	
60" x 108"	rectangle	HPL	rectangle	RYRL60108RES	1	1	24" x 75"	8090	8280	10,565	11,860	Contact Factory	
60" x 108"	racetrack	HPL	cube	RYCL60108RTS	1	2	24"	6685	6885	9530	10,880	Contact Factory	
60" x 108"	racetrack	HPL	panel	RYPL60108RTS	1	2	30"	4185	4385	7030	8380	Contact Factory	
60" x 108"	racetrack	HPL	rectangle	RYRL60108RTS	1	1	24" x 75"	8170	8370	11,015	12,365	Contact Factory	
60" x 108"	boat-shape	HPL	cube	RYCL60108BTS	1	2	24"	6685	6885	9530	10,880	Contact Factory	
60" x 108"	boat-shape	HPL	panel	RYPL60108BTS	1	2	30"	4185	4385	7030	8380	Contact Factory	
60" x 108"	boat-shape	HPL	rectangle	RYRL60108BTS	1	1	24" x 75"	8170	8370	11,015	12,365	Contact Factory	
60" x 120"	rectangle	HPL	cube	RYCL60120RES	1	2	24"	6620	6810	9090	10,380	Contact Factory	
60" x 120"	rectangle	HPL	panel	RYPL60120RES	1	2	30"	4175	4365	6645	7935	Contact Factory	
60" x 120"	rectangle	HPL	rectangle	RYRL60120RES	1	1	24" x 75"	8105	8295	10,575	11,865	Contact Factory	
60" x 120"	racetrack	HPL	cube	RYCL60120RTS	1	2	24"	6690	6895	9540	10,900	Contact Factory	
60" x 120"	racetrack	HPL	panel	RYPL60120RTS	1	2	30"	4245	4450	7095	8455	Contact Factory	
60" x 120"	racetrack	HPL	rectangle	RYRL60120RTS	1	1	24" x 75"	8175	8380	11,025	12,385	Contact Factory	
60" x 120"	boat-shape	HPL	cube	RYCL60120BTS	1	2	24"	6690	6895	9540	10,900	Contact Factory	
60" x 120"	boat-shape	HPL	panel	RYPL60120BTS	1	2	30"	4245	4450	7095	8455	Contact Factory	
60" x 120"	boat-shape	HPL	rectangle	RYRL60120BTS	1	1	24" x 75"	8175	8380	11,025	12,385	Contact Factory	

TABLE OPTIONS

Custom Stain for wood edges and veneers
 Premium Laminate
 Premium Edge-banding

UCS \$600 per color
 UCL Contact Factory
 UCE Contact Factory

POWER & A/V OPTIONS : [page 21 - 38]

Non-powered round ABS plastic Grommet (black or silver) | List location code on page 18
 Non-powered rectangle metal Grommet (black or silver) | List location code on page 18

G (B/S) \$20 per grommet
 GV (B/S) \$120 per grommet

WIRE MANAGEMENT: [page 40 - 42]

Customer specified hole cut into top
 36" long Horizontal 4 track Extruded Raceway
 Horizontal conference Wire Management Trough

CNC \$250 set up fee per template
 WH \$80 per piece
 WT \$475 per table

ACCESSORIES: [pages 39 - 49 for options]

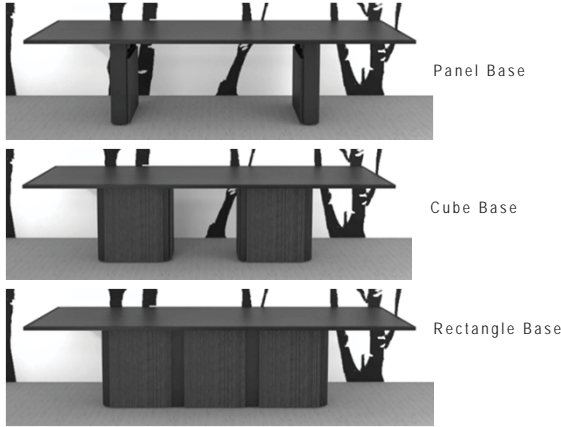

Laminate & FormaWrap Tables



Table Size	Top Shape	Base Material	Base Shape	Model Code:	Top QTY	Base QTY	Base Size						
60" x 144"	rectangle	HPL	cube	RYCL60144RES	2	3	24"	9515	9740	12,525	14,075	Contact	Factory
60" x 144"	rectangle	HPL	panel	RYPL60144RES	2	3	30"	5750	5975	8760	10,310	Contact	Factory
60" x 144"	rectangle	HPL	rectangle	RYRL60144RES	2	1	24" x 100"	10415	10640	13,425	14,975	Contact	Factory
60" x 144"	racetrack	HPL	cube	RYCL60144RTS	2	3	24"	9595	9830	12,965	14,575	Contact	Factory
60" x 144"	racetrack	HPL	panel	RYPL60144RTS	2	3	30"	5830	6065	9200	10,810	Contact	Factory
60" x 144"	racetrack	HPL	rectangle	RYRL60144RTS	2	1	24" x 100"	10495	10730	13,865	15,475	Contact	Factory
60" x 144"	boat-shape	HPL	cube	RYCL60144BTS	2	3	24"	9595	9830	12,965	14,575	Contact	Factory
60" x 144"	boat-shape	HPL	panel	RYPL60144BTS	2	3	30"	5830	6065	9200	10,810	Contact	Factory
60" x 144"	boat-shape	HPL	rectangle	RYRL60144BTS	2	1	24" x 100"	10495	10730	13,865	15,475	Contact	Factory
60" x 168"	rectangle	HPL	cube	RYCL60168RES	2	3	24"	10285	10625	13,245	15,060	Contact	Factory
60" x 168"	rectangle	HPL	panel	RYPL60168RES	2	3	30"	6630	6970	9590	11,405	Contact	Factory
60" x 168"	rectangle	HPL	rectangle	RYRL60168RES	2	1	24" x 125"	13275	13615	16,235	18,050	Contact	Factory
60" x 168"	racetrack	HPL	cube	RYCL60168RTS	2	3	24"	10325	10665	13,700	15,565	Contact	Factory
60" x 168"	racetrack	HPL	panel	RYPL60168RTS	2	3	30"	6670	7010	10,045	11,910	Contact	Factory
60" x 168"	racetrack	HPL	rectangle	RYRL60168RTS	2	1	24" x 125"	13315	13655	16,690	18,555	Contact	Factory
60" x 168"	boat-shape	HPL	cube	RYCL60168BTS	2	3	24"	10325	10665	13,700	15,565	Contact	Factory
60" x 168"	boat-shape	HPL	panel	RYPL60168BTS	2	3	30"	6670	7010	10,045	11,910	Contact	Factory
60" x 168"	boat-shape	HPL	rectangle	RYRL60168BTS	2	1	24" x 125"	13315	13655	16,690	18,555	Contact	Factory
60" x 192"	rectangle	HPL	cube	RYCL60192RES	2	3	24"	10,315	10,655	13,990	16,070	Contact	Factory
60" x 192"	rectangle	HPL	panel	RYPL60192RES	2	3	30"	6770	7110	10,445	12,525	Contact	Factory
60" x 192"	rectangle	HPL	rectangle	RYRL60192RES	2	1	24" x 150"	15,395	15,735	19,070	21,150	Contact	Factory
60" x 192"	racetrack	HPL	cube	RYCL60192RTS	2	3	24"	10,355	10,705	14,445	16,570	Contact	Factory
60" x 192"	racetrack	HPL	panel	RYPL60192RTS	2	3	30"	6810	7160	10,900	13,025	Contact	Factory
60" x 192"	racetrack	HPL	rectangle	RYRL60192RTS	2	1	24" x 150"	15,435	15,785	19,525	21,650	Contact	Factory
60" x 192"	boat-shape	HPL	cube	RYCL60192BTS	2	3	24"	10,355	10,705	14,445	16,570	Contact	Factory
60" x 192"	boat-shape	HPL	panel	RYPL60192BTS	2	3	30"	6810	7160	10,900	13,025	Contact	Factory
60" x 192"	boat-shape	HPL	rectangle	RYRL60192BTS	2	1	24" x 150"	15,435	15,785	19,525	21,650	Contact	Factory
60" x 228"	rectangle	HPL	cube	RYCL60228RES	2	4	24"	13,500	13,925	18,160	20,755	Contact	Factory
60" x 228"	rectangle	HPL	panel	RYPL60228RES	2	4	30"	8740	9165	13,400	15,995	Contact	Factory
60" x 228"	rectangle	HPL	rectangle	RYRL60228RES	2	1	24" x 175"	20,085	20,510	24,745	27,340	Contact	Factory
60" x 228"	racetrack	HPL	cube	RYCL60228RTS	2	4	24"	13,515	13,935	18,615	21,255	Contact	Factory
60" x 228"	racetrack	HPL	panel	RYPL60228RTS	2	4	30"	8755	9175	13,855	16,495	Contact	Factory
60" x 228"	racetrack	HPL	rectangle	RYRL60228RTS	2	1	24" x 175"	20,100	20,520	25,200	27,840	Contact	Factory
60" x 228"	boat-shape	HPL	cube	RYCL60228BTS	2	4	24"	13,515	13,935	18,615	21,255	Contact	Factory
60" x 228"	boat-shape	HPL	panel	RYPL60228BTS	2	4	30"	8755	9175	13,855	16,495	Contact	Factory
60" x 228"	boat-shape	HPL	rectangle	RYRL60228BTS	2	1	24" x 175"	20,100	20,520	25,200	27,840	Contact	Factory

TABLE OPTIONS

Custom Stain for wood edges and veneers	UCS	\$600 per color
Premium Laminate	UCL	Contact Factory
Premium Edge-banding	UCE	Contact Factory

POWER & A/V OPTIONS : [page 21- 38]

Non-powered round ABS plastic Grommet (black or silver) List location code on page 18	G (B/S)	\$20 per grommet
Non-powered rectangle metal Grommet (black or silver) List location code on page 18	GV (B/S)	\$120 per grommet

WIRE MANAGEMENT: [page 40 - 42]

Customer specified hole cut into top	CNC	\$250 set up fee per template
36" long Horizontal 4 track Extruded Raceway	WH	\$80 per piece
Horizontal conference Wire Management Trough	WT	\$475 per table

ACCESSORIES: [pages 39 - 49 for options]

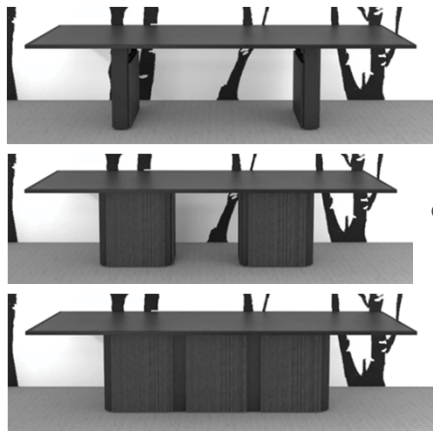

Laminate & FormaWrap Tables

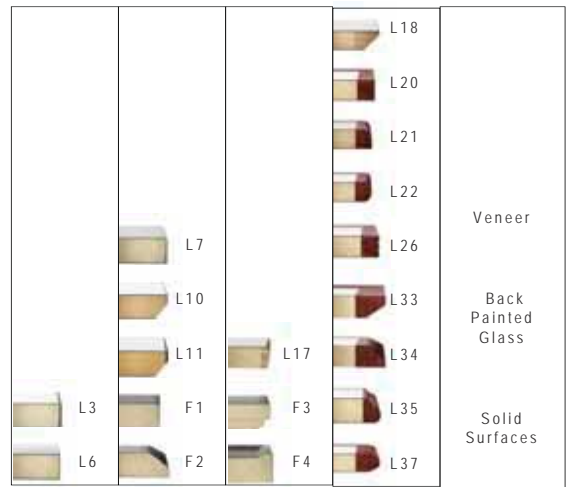

Table Size	Top Shape	Base Material	Base Shape	Model Code:	Top QTY	Base QTY	Base Size					
72" x 96"	rectangle	HPL	cube	RYCL7296RE	2	2	30"	7420	7695	8940	10,340	Contact Factory
72" x 96"	rectangle	HPL	panel	RYPL7296RE	2	2	36"	4675	5040	6285	7685	Contact Factory
72" x 96"	rectangle	HPL	rectangle	RYRL7296RE	2	1	36" x 50"	6750	7025	8270	9670	Contact Factory
72" x 96"	racetrack	HPL	cube	RYCL7296RT	2	2	30"	7415	7695	9700	11,380	Contact Factory
72" x 96"	racetrack	HPL	panel	RYPL7296RT	2	2	36"	4760	5040	7045	8725	Contact Factory
72" x 96"	racetrack	HPL	rectangle	RYRL7296RT	2	1	36" x 50"	6745	7025	9030	10,710	Contact Factory
72" x 96"	boat-shape	HPL	cube	RYCL7296BT	2	2	30"	7415	7695	9700	11,380	Contact Factory
72" x 96"	boat-shape	HPL	panel	RYPL7296BT	2	2	36"	4760	5040	7045	8725	Contact Factory
72" x 96"	boat-shape	HPL	rectangle	RYRL7296BT	2	1	36" x 50"	6745	7025	9030	10,710	Contact Factory
72" x 108"	rectangle	HPL	cube	RYCL72108RE	2	2	30"	7780	8110	10,055	11,610	Contact Factory
72" x 108"	rectangle	HPL	panel	RYPL72108RE	2	2	36"	5180	5510	7455	9010	Contact Factory
72" x 108"	rectangle	HPL	rectangle	RYRL72108RE	2	1	36" x 75"	9035	9365	11,310	12,865	Contact Factory
72" x 108"	racetrack	HPL	cube	RYCL72108RT	2	2	30"	7790	8120	10,950	12,620	Contact Factory
72" x 108"	racetrack	HPL	panel	RYPL72108RT	2	2	36"	5190	5520	8350	10,020	Contact Factory
72" x 108"	racetrack	HPL	rectangle	RYRL72108RT	2	1	36" x 75"	9045	9375	12,205	13,875	Contact Factory
72" x 108"	boat-shape	HPL	cube	RYCL72108BT	2	2	30"	7790	8120	10,950	12,620	Contact Factory
72" x 108"	boat-shape	HPL	panel	RYPL72108BT	2	2	36"	5190	5520	8350	10,020	Contact Factory
72" x 108"	boat-shape	HPL	rectangle	RYRL72108BT	2	1	36" x 75"	9045	9375	12,205	13,875	Contact Factory
72" x 120"	rectangle	HPL	cube	RYCL72120RE	2	2	30"	7795	8125	10,060	11,630	Contact Factory
72" x 120"	rectangle	HPL	panel	RYPL72120RE	2	2	36"	5250	5580	7515	9085	Contact Factory
72" x 120"	rectangle	HPL	rectangle	RYRL72120RE	2	1	36" x 75"	9050	9380	11,315	12,875	Contact Factory
72" x 120"	racetrack	HPL	cube	RYCL72120RT	2	2	30"	7795	8130	10,955	12,730	Contact Factory
72" x 120"	racetrack	HPL	panel	RYPL72120RT	2	2	36"	5250	5585	8410	10,185	Contact Factory
72" x 120"	racetrack	HPL	rectangle	RYRL72120RT	2	1	36" x 75"	9050	9385	12,210	13,985	Contact Factory
72" x 120"	boat-shape	HPL	cube base	RYCL72120BT	2	2	30"	7795	8130	10,955	12,730	Contact Factory
72" x 120"	boat-shape	HPL	panel	RYPL72120BT	2	2	36"	5250	5585	8410	10,185	Contact Factory
72" x 120"	boat-shape	HPL	rectangle	RYRL72120BT	2	1	36" x 75"	9050	9385	12,210	13,985	Contact Factory
72" x 144"	rectangle	HPL	cube	RYCL72144RE	3	2	30"	8170	8555	10,610	12,730	Contact Factory
72" x 144"	rectangle	HPL	panel	RYPL72144RE	3	3	36"	7045	7430	9485	11,605	Contact Factory
72" x 144"	rectangle	HPL	rectangle	RYRL72144RE	3	1	36" x 100"	11,680	12,065	14,120	16,240	Contact Factory
72" x 144"	racetrack	HPL	cube	RYCL72144RT	3	2	30"	8180	8565	11,630	13,630	Contact Factory
72" x 144"	racetrack	HPL	panel	RYPL72144RT	3	3	36"	7055	7440	10,505	12,505	Contact Factory
72" x 144"	racetrack	HPL	rectangle	RYRL72144RT	3	1	36" x 100"	11,690	12,075	15,140	17,140	Contact Factory
72" x 144"	boat-shape	HPL	cube	RYCL72144BT	3	2	30"	8180	8565	11,630	13,630	Contact Factory
72" x 144"	boat-shape	HPL	panel	RYPL72144BT	3	3	36"	7055	7440	10,505	12,505	Contact Factory
72" x 144"	boat-shape	HPL	rectangle	RYRL72144BT	3	1	36" x 100"	11,690	12,075	15,140	17,140	Contact Factory

TABLE OPTIONS

Custom Stain for wood edges and veneers	UCS	\$600 per color
Premium Laminate	UCL	Contact Factory
Premium Edge-banding	UCE	Contact Factory

POWER & AV OPTIONS : [page 21- 38]

Non-powered round ABS plastic Grommet (black or silver) List location code on page 18	G (B/S)	\$20 per grommet
Non-powered rectangle metal Grommet (black or silver) List location code on page 18	GV (B/S)	\$120 per grommet

WIRE MANAGEMENT: [page 40 - 42]

Customer specified hole cut into top	CNC	\$250 set up fee per template
36" long Horizontal 4 track Extruded Raceway	WH	\$80 per piece
Horizontal conference Wire Management Trough	WT	\$475 per table

ACCESSORIES: [pages 39 - 49 for options]

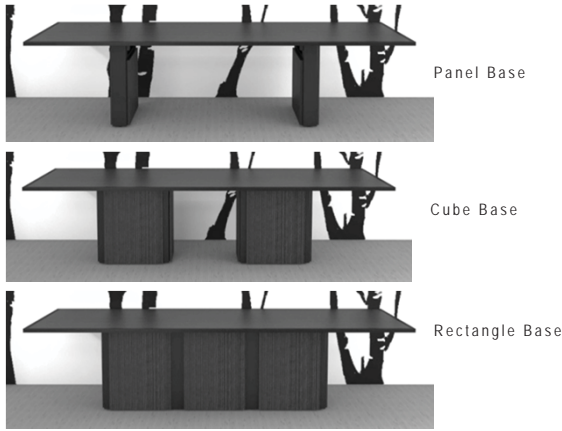

Laminate & FormaWrap Tables



Table Size	Top Shape	Base Material	Base Shape	Model Code:	Top QTY	Base QTY	Base Size					
72" x 168"	rectangle	HPL	cube	RYCL72168RE	3	3	30"	11,920	12,450	14,635	16,185	Contact Factory
72" x 168"	rectangle	HPL	panel	RYPL72168RE	3	3	36"	8115	8645	10,830	13,010	Contact Factory
72" x 168"	rectangle	HPL	rectangle	RYRL72168RE	3	1	36" x 125"	14,730	15,260	17,445	19,625	Contact Factory
72" x 168"	racetrack	HPL	cube	RYCL72168RT	3	3	30"	11,880	12,405	15,310	17,570	Contact Factory
72" x 168"	racetrack	HPL	panel	RYPL72168RT	3	3	36"	8075	8600	11,505	13,765	Contact Factory
72" x 168"	racetrack	HPL	rectangle	RYRL72168RT	3	1	36" x 125"	14,690	15,215	18,120	20,380	Contact Factory
72" x 168"	boat-shape	HPL	cube	RYCL72168BT	3	3	30"	11,880	12,405	15,310	17,570	Contact Factory
72" x 168"	boat-shape	HPL	panel	RYPL72168BT	3	3	36"	8075	8600	11,505	13,765	Contact Factory
72" x 168"	boat-shape	HPL	rectangle	RYRL72168BT	3	1	36" x 125"	14,690	15,215	18,120	20,380	Contact Factory
72" x 192"	rectangle	HPL	cube	RYCL72192RE	4	3	30"	11,950	12,485	15,530	18,020	Contact Factory
72" x 192"	rectangle	HPL	panel	RYPL72192RE	4	3	36"	8225	8790	11,835	14,325	Contact Factory
72" x 192"	rectangle	HPL	rectangle	RYRL72192RE	4	1	36" x 150"	16,850	17,385	20,430	22,920	Contact Factory
72" x 192"	racetrack	HPL	cube	RYCL72192RT	4	3	30"	11,915	12,445	16,210	18,775	Contact Factory
72" x 192"	racetrack	HPL	panel	RYPL72192RT	4	3	36"	8220	8750	12,515	15,080	Contact Factory
72" x 192"	racetrack	HPL	rectangle	RYRL72192RT	4	1	36" x 150"	16,815	17,345	21,110	23,675	Contact Factory
72" x 192"	boat-shape	HPL	cube	RYCL72192BT	4	3	30"	11,915	12,445	16,210	18,775	Contact Factory
72" x 192"	boat-shape	HPL	panel	RYPL72192BT	4	3	36"	8220	8750	12,515	15,080	Contact Factory
72" x 192"	boat-shape	HPL	rectangle	RYRL72192BT	4	1	36" x 150"	16,815	17,345	21,110	23,675	Contact Factory
72" x 228"	rectangle	HPL	cube	RYCL72228RE	4	4	30"	15,510	16,165	20,120	23,250	Contact Factory
72" x 228"	rectangle	HPL	panel	RYPL72228RE	4	4	36"	10,555	11,210	15,165	18,295	Contact Factory
72" x 228"	rectangle	HPL	rectangle	RYRL72228RE	4	1	36" x 175"	21,800	22,455	26,415	29,540	Contact Factory
72" x 228"	racetrack	HPL	cube	RYCL72228RT	4	4	30"	15,445	16,090	20,800	23,990	Contact Factory
72" x 228"	racetrack	HPL	panel	RYPL72228RT	4	4	36"	10,490	11,135	15,845	19,035	Contact Factory
72" x 228"	racetrack	HPL	rectangle	RYRL72228RT	4	1	36" x 175"	21,735	22,380	27,090	30,280	Contact Factory
72" x 228"	boat-shape	HPL	cube	RYCL72228BT	4	4	30"	15,445	16,090	20,800	23,990	Contact Factory
72" x 228"	boat-shape	HPL	panel	RYPL72228BT	4	4	36"	10,490	11,135	15,845	19,035	Contact Factory
72" x 228"	boat-shape	HPL	rectangle	RYRL72228BT	4	1	36" x 175"	21,735	22,380	27,090	30,280	Contact Factory

TABLE OPTIONS

Custom Stain for wood edges and veneers	UCS	\$600 per color
Premium Laminate	UCL	Contact Factory
Premium Edge-banding	UCE	Contact Factory

POWER & AV OPTIONS : [page 21- 38]

Non-powered round ABS plastic Grommet (black or silver) List location code on page 18	G (B/S)	\$20 per grommet
Non-powered rectangle metal Grommet (black or silver) List location code on page 18	GV (B/S)	\$120 per grommet

WIRE MANAGEMENT: [page 40 - 42]

Customer specified hole cut into top	CNC	\$250 set up fee per template
36" long Horizontal 4 track Extruded Raceway	WH	\$80 per piece
Horizontal conference Wire Management Trough	WT	\$475 per table

ACCESSORIES: [pages 39 - 49 for options]

Laminate & FormaWrap Tables



U Shaped Base



Table Size	Base Material	Base Shape	Base Model Code:	Top QTY	Top Depth	Base QTY/Size						
84" w x 68" l	HPL	panel	RYUL846830USS	3	30"	12) 18"w	9650	9870	11,120	12,285	Contact	Factory
84" w x 86" l	HPL	panel	RYUL848630USS	3	30"	16) 18"w	12,285	12,525	13,945	15,260	Contact	Factory
84" w x 108" l	HPL	panel	RYUL8410830USS	3	30"	20) 18"w	14,970	15,240	17,460	19,215	Contact	Factory
84" w x 124" l	HPL	panel	RYUL8412430USS	3	30"	24) 18"w	17,465	17,850	19,945	21,730	Contact	Factory
84" w x 144" l	HPL	panel	RYUL8414430USS	3	30"	28) 18"w	20,190	20,520	22,720	25,205	Contact	Factory
84" w x 162" l	HPL	panel	RYUL8416230USS	5	30"	32) 18"w	22,385	23,815	26,275	28,620	Contact	Factory
84" w x 180" l	HPL	panel	RYUL8418030USS	5	30"	36) 18"w	26,000	26,450	30,150	33,075	Contact	Factory
84" w x 200" l	HPL	panel	RYUL8420030USS	5	30"	40) 18"w	28,515	29,005	32,645	35,630	Contact	Factory
84" w x 220" l	HPL	panel	RYUL8422030USS	5	30"	44) 18"w	30,990	31,480	35,120	38,105	Contact	Factory
84" w x 240" l	HPL	panel	RYUL8424030USS	5	30"	48) 18"w	33,965	34,535	38,195	42,580	Contact	Factory
84" w x 68" l	HPL	panel	RYUL846836USS	3	36"	12) 18"w	10,085	10,350	11,675	13,080	Contact	Factory
84" w x 86" l	HPL	panel	RYUL848636USS	3	36"	16) 18"w	12,750	13,035	14,570	16,145	Contact	Factory
84" w x 108" l	HPL	panel	RYUL8410836USS	3	36"	20) 18"w	15,825	16,200	18,285	20,400	Contact	Factory
84" w x 124" l	HPL	panel	RYUL8412436USS	3	36"	24) 18"w	18,320	18,705	20,810	22,925	Contact	Factory
84" w x 144" l	HPL	panel	RYUL8414436USS	3	36"	28) 18"w	21,165	21,610	24,375	26,630	Contact	Factory
84" w x 162" l	HPL	panel	RYUL8416236USS	5	36"	32) 18"w	24,070	24,595	27,390	31,985	Contact	Factory
84" w x 180" l	HPL	panel	RYUL8418036USS	5	36"	36) 18"w	27,425	28,050	31,525	35,050	Contact	Factory
84" w x 200" l	HPL	panel	RYUL8420036USS	5	36"	40) 18"w	29,940	30,585	34,100	37,625	Contact	Factory
84" w x 220" l	HPL	panel	RYUL8422036USS	5	36"	44) 18"w	32,415	33,060	36,575	40,100	Contact	Factory
84" w x 240" l	HPL	panel	RYUL8424036USS	5	36"	48) 18"w	35,630	36,395	41,230	45,035	Contact	Factory
96" w x 80" l	HPL	panel	RYUL968030USS	3	30"	12) 24"w	9820	9970	10,650	11,380	Contact	Factory
96" w x 108" l	HPL	panel	RYUL9610830USS	3	30"	16) 24"w	12,505	12,685	14,165	15,335	Contact	Factory
96" w x 130" l	HPL	panel	RYUL9613030USS	5	30"	20) 24"w	15,690	15,990	17,350	18,810	Contact	Factory
96" w x 156" l	HPL	panel	RYUL9615630USS	5	30"	24) 24"w	18,445	18,885	21,330	23,690	Contact	Factory
96" w x 180" l	HPL	panel	RYUL9618030USS	5	30"	28) 24"w	21,060	21,520	25,205	28,145	Contact	Factory
96" w x 204" l	HPL	panel	RYUL9620430USS	5	30"	32) 24"w	23,575	24,075	27,700	30,700	Contact	Factory
96" w x 230" l	HPL	panel	RYUL9623030USS	5	30"	36) 24"w	26,550	27,130	30,775	35,175	Contact	Factory
96" w x 256" l	HPL	panel	RYUL9625630USS	5	30"	40) 24"w	29,025	29,605	33,250	37,650	Contact	Factory
96" w x 280" l	HPL	panel	RYUL9628030USS	7	30"	44) 24"w	32,090	32,730	37,895	42,005	Contact	Factory
96" w x 305" l	HPL	panel	RYUL9630530USS	7	30"	48) 24"w	34,625	35,325	40,400	44,600	Contact	Factory
96" w x 80" l	HPL	panel	RYUL968036USS	3	36"	12) 24"w	10,095	10,365	11,700	13,105	Contact	Factory
96" w x 108" l	HPL	panel	RYUL9610836USS	3	36"	16) 24"w	12,520	13,260	15,015	16,790	Contact	Factory
96" w x 130" l	HPL	panel	RYUL9613036USS	5	36"	20) 24"w	16,335	16,785	19,170	21,615	Contact	Factory
96" w x 156" l	HPL	panel	RYUL9615636USS	5	36"	24) 24"w	18,810	19,260	21,645	24,090	Contact	Factory
96" w x 180" l	HPL	panel	RYUL9618036USS	5	36"	28) 24"w	21,645	22,155	24,960	27,805	Contact	Factory
96" w x 204" l	HPL	panel	RYUL9620436USS	5	36"	32) 24"w	24,960	25,590	29,075	32,600	Contact	Factory
96" w x 230" l	HPL	panel	RYUL9623036USS	5	36"	36) 24"w	28,215	28,985	33,830	37,635	Contact	Factory
96" w x 256" l	HPL	panel	RYUL9625636USS	5	36"	40) 24"w	30,690	31,460	36,305	40,110	Contact	Factory
96" w x 280" l	HPL	panel	RYUL9628036USS	7	36"	44) 24"w	34,085	34,965	39,840	44,775	Contact	Factory
96" w x 305" l	HPL	panel	RYUL9630536USS	7	36"	48) 24"w	36,620	37,530	42,465	47,400	Contact	Factory
108" w x 96" l	HPL	panel	RYUL1089630USS	3	30"	12) 30"w	10,085	10,375	11,965	13,795	Contact	Factory
108" w x 128" l	HPL	panel	RYUL10812830USS	3	30"	16) 30"w	12,900	13,260	15,450	18,300	Contact	Factory
108" w x 160" l	HPL	panel	RYUL10816030USS	5	30"	20) 30"w	16,095	16,555	19,005	21,715	Contact	Factory
108" w x 190" l	HPL	panel	RYUL10819030USS	5	30"	24) 30"w	18,710	19,190	22,880	26,170	Contact	Factory
108" w x 220" l	HPL	panel	RYUL10822030USS	5	30"	28) 30"w	21,225	21,745	25,375	28,225	Contact	Factory
108" w x 252" l	HPL	panel	RYUL10825230USS	5	30"	32) 30"w	24,200	24,800	28,450	33,200	Contact	Factory
108" w x 282" l	HPL	panel	RYUL10828230USS	7	30"	36) 30"w	27,265	27,925	33,095	38,595	Contact	Factory
108" w x 314" l	HPL	panel	RYUL10831430USS	7	30"	40) 30"w	29,800	30,520	35,600	40,150	Contact	Factory
108" w x 346" l	HPL	panel	RYUL10834630USS	7	30"	44) 30"w	33,025	33,865	38,975	45,625	Contact	Factory

TABLE OPTIONS

POWER & A/V OPTIONS : [page 21- 38]

WIRE MANAGEMENT: [page 40 - 42]

ACCESSORIES: [pages 39 - 49 for options]



U Shaped Base

Laminate & FormaWrap Tables

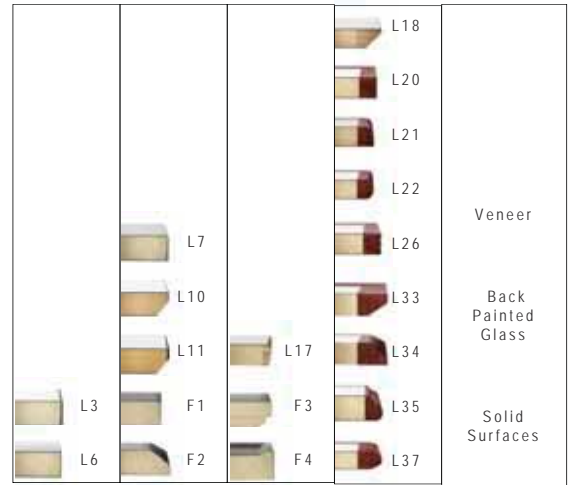

Table Size	Base Material	Base Shape	Model Code:	Top QTY	Top Depth	Base QTY/Size					
108" w x 96" l	HPL	panel	RYUL1089636USS	3	36"	12) 30"w	10630	10990	13075	14910	Contact Factory
108" w x 128" l	HPL	panel	RYUL10812836USS	3	36"	16) 30"w	13565	13985	16430	18615	Contact Factory
108" w x 160" l	HPL	panel	RYUL10816036USS	5	36"	20) 30"w	16840	17400	20535	23430	Contact Factory
108" w x 190" l	HPL	panel	RYUL10819036USS	5	36"	24) 30"w	20195	20855	24670	28265	Contact Factory
108" w x 220" l	HPL	panel	RYUL10822036USS	5	36"	28) 30"w	22710	23390	27245	30840	Contact Factory
108" w x 252" l	HPL	panel	RYUL10825236USS	5	36"	32) 30"w	25925	26725	31900	35775	Contact Factory
108" w x 282" l	HPL	panel	RYUL10828236USS	7	36"	36) 30"w	29320	30230	35435	40440	Contact Factory
108" w x 314" l	HPL	panel	RYUL10831436USS	7	36"	40) 30"w	31855	32975	38060	43065	Contact Factory
108" w x 346" l	HPL	panel	RYUL10834636USS	7	36"	44) 30"w	33025	36560	43805	49230	Contact Factory
120" w x 80" l	HPL	panel	RYUL1208030USS	3	30"	14) 24"w	11,180	11,450	12,860	14,540	Contact Factory
120" w x 108" l	HPL	panel	RYUL12010830USS	3	30"	18) 24"w	13,865	14,165	16,375	18,495	Contact Factory
120" w x 130" l	HPL	panel	RYUL12013030USS	5	30"	22) 24"w	17,050	17,470	21,120	22,970	Contact Factory
120" w x 156" l	HPL	panel	RYUL12015630USS	5	30"	26) 24"w	19,805	20,265	22,715	25,425	Contact Factory
120" w x 180" l	HPL	panel	RYUL12018030USS	5	30"	30) 24"w	22,420	22,900	26,590	29,880	Contact Factory
120" w x 204" l	HPL	panel	RYUL12020430USS	5	30"	34) 24"w	24,935	25,455	29,085	32,435	Contact Factory
120" w x 230" l	HPL	panel	RYUL12023030USS	5	30"	38) 24"w	27,910	28,510	32,160	36,910	Contact Factory
120" w x 256" l	HPL	panel	RYUL12025630USS	5	30"	42) 24"w	30,385	30,985	34,635	39,385	Contact Factory
120" w x 280" l	HPL	panel	RYUL12028030USS	7	30"	46) 24"w	33,450	34,110	39,280	43,740	Contact Factory
120" w x 305" l	HPL	panel	RYUL12030530USS	7	30"	50) 24"w	35,985	36,705	41,785	46,335	Contact Factory
120" w x 80" l	HPL	panel	RYUL1208036USS	3	36"	14) 24"w	11,515	11,815	13,480	14,955	Contact Factory
120" w x 108" l	HPL	panel	RYUL12010836USS	3	36"	18) 24"w	14,360	14,710	16,795	18,640	Contact Factory
120" w x 130" l	HPL	panel	RYUL12013036USS	3	36"	22) 24"w	17,275	17,695	20,140	22,325	Contact Factory
120" w x 156" l	HPL	panel	RYUL12015636USS	3	36"	26) 24"w	20,120	20,600	23,705	26,030	Contact Factory
120" w x 180" l	HPL	panel	RYUL12018036USS	5	36"	30) 24"w	23,065	23,605	26,740	29,655	Contact Factory
120" w x 204" l	HPL	panel	RYUL12020436USS	5	36"	34) 24"w	26,380	27,040	30,855	34,450	Contact Factory
120" w x 230" l	HPL	panel	RYUL12023036USS	5	36"	38) 24"w	29,635	30,435	35,610	39,485	Contact Factory
120" w x 256" l	HPL	panel	RYUL12025636USS	5	36"	42) 24"w	32,110	32,910	38,085	41,960	Contact Factory
120" w x 280" l	HPL	panel	RYUL12028036USS	7	36"	46) 24"w	35,505	36,415	41,620	46,625	Contact Factory
120" w x 305" l	HPL	panel	RYUL12030536USS	7	36"	50) 24"w	38,040	38,980	44,245	49,250	Contact Factory
120" w x 80" l	HPL	panel	RYUL1208030USS	3	30"	14) 24"w	11,180	11,450	12,860	14,540	Contact Factory
120" w x 108" l	HPL	panel	RYUL12010830USS	3	30"	18) 24"w	13,865	14,165	16,375	18,495	Contact Factory
120" w x 130" l	HPL	panel	RYUL12013030USS	5	30"	22) 24"w	17,050	17,470	21,120	22,970	Contact Factory
120" w x 156" l	HPL	panel	RYUL12015630USS	5	30"	26) 24"w	19,805	20,265	22,715	25,425	Contact Factory
120" w x 180" l	HPL	panel	RYUL12018030USS	5	30"	30) 24"w	22,420	22,900	26,590	29,880	Contact Factory
120" w x 204" l	HPL	panel	RYUL12020430USS	5	30"	34) 24"w	24,935	25,455	29,085	32,435	Contact Factory
120" w x 230" l	HPL	panel	RYUL12023030USS	5	30"	38) 24"w	27,910	28,510	32,160	36,910	Contact Factory
120" w x 256" l	HPL	panel	RYUL12025630USS	5	30"	42) 24"w	30,385	30,985	34,635	39,385	Contact Factory
120" w x 280" l	HPL	panel	RYUL12028030USS	7	30"	46) 24"w	33,450	34,110	39,280	43,740	Contact Factory
120" w x 305" l	HPL	panel	RYUL12030530USS	7	30"	50) 24"w	35,985	36,705	41,785	46,335	Contact Factory
120" w x 80" l	HPL	panel	RYUL1208036USS	3	36"	14) 24"w	11,515	11,815	13,480	14,955	Contact Factory
120" w x 108" l	HPL	panel	RYUL12010836USS	3	36"	18) 24"w	14,360	14,710	16,795	18,640	Contact Factory
120" w x 130" l	HPL	panel	RYUL12013036USS	3	36"	22) 24"w	17,275	17,695	20,140	22,325	Contact Factory
120" w x 156" l	HPL	panel	RYUL12015636USS	3	36"	26) 24"w	20,120	20,600	23,705	26,030	Contact Factory
120" w x 180" l	HPL	panel	RYUL12018036USS	5	36"	30) 24"w	23,065	23,605	26,740	29,655	Contact Factory
120" w x 204" l	HPL	panel	RYUL12020436USS	5	36"	34) 24"w	26,380	27,040	30,855	34,450	Contact Factory
120" w x 230" l	HPL	panel	RYUL12023036USS	5	36"	38) 24"w	29,635	30,435	35,610	39,485	Contact Factory
120" w x 256" l	HPL	panel	RYUL12025636USS	5	36"	42) 24"w	32,110	32,910	38,085	41,960	Contact Factory
120" w x 280" l	HPL	panel	RYUL12028036USS	7	36"	46) 24"w	35,505	36,415	41,620	46,625	Contact Factory
120" w x 305" l	HPL	panel	RYUL12030536USS	7	36"	50) 24"w	38,040	38,980	44,245	49,250	Contact Factory

TABLE OPTIONS

POWER & A/V OPTIONS : [page 21- 38]

WIRE MANAGEMENT: [page 40 - 42]

ACCESSORIES: [pages 39 - 49 for options]



U Shaped Base

Laminate & FormaWrap Tables



Table Size	Base Material	Base Shape	Model Code:	Top QTY	Top Depth	Base QTY/Size					
144" w x 80" l	HPL	panel	RYUL1448030USS	4	30"	16) 24"w	12,800	13,120	14,650	16,280	Contact Factory
144" w x 108" l	HPL	panel	RYUL14410830USS	4	30"	20) 24"w	15,485	15,835	18,165	20,235	Contact Factory
144" w x 130" l	HPL	panel	RYUL14413030USS	6	30"	24) 24"w	18,230	18,640	20,950	23,750	Contact Factory
144" w x 156" l	HPL	panel	RYUL14415630USS	6	30"	28) 24"w	21,425	21,935	24,505	27,165	Contact Factory
144" w x 180" l	HPL	panel	RYUL14418030USS	6	30"	32) 24"w	24,040	24,570	28,380	31,620	Contact Factory
144" w x 204" l	HPL	panel	RYUL14420430USS	6	30"	36) 24"w	26,555	27,125	30,875	34,175	Contact Factory
144" w x 230" l	HPL	panel	RYUL14423030USS	6	30"	40) 24"w	29,530	30,180	33,950	38,650	Contact Factory
144" w x 256" l	HPL	panel	RYUL14425630USS	6	30"	44) 24"w	32,005	32,655	36,425	41,125	Contact Factory
144" w x 280" l	HPL	panel	RYUL14428030USS	8	30"	48) 24"w	35,070	35,780	41,070	45,480	Contact Factory
144" w x 305" l	HPL	panel	RYUL14430530USS	8	30"	52) 24"w	37,605	38,375	43,575	48,075	Contact Factory
144" w x 80" l	HPL	panel	RYUL1448036USS	4	36"	16) 24"w	12,990	13,320	15,000	16,770	Contact Factory
144" w x 108" l	HPL	panel	RYUL14410836USS	4	36"	20) 24"w	15,835	16,215	18,315	20,455	Contact Factory
144" w x 130" l	HPL	panel	RYUL14413036USS	4	36"	24) 24"w	18,750	19,200	21,660	24,140	Contact Factory
144" w x 156" l	HPL	panel	RYUL14415636USS	4	36"	28) 24"w	21,595	22,105	25,225	27,845	Contact Factory
144" w x 180" l	HPL	panel	RYUL14418036USS	6	36"	32) 24"w	24,540	25,110	28,260	31,470	Contact Factory
144" w x 204" l	HPL	panel	RYUL14420436USS	6	36"	36) 24"w	27,855	28,545	32,375	36,265	Contact Factory
144" w x 230" l	HPL	panel	RYUL14423036USS	6	36"	40) 24"w	31,110	31,940	37,130	41,300	Contact Factory
144" w x 256" l	HPL	panel	RYUL14425636USS	6	36"	44) 24"w	31,495	34,415	39,605	43,775	Contact Factory
144" w x 280" l	HPL	panel	RYUL14428036USS	8	36"	48) 24"w	36,980	37,920	43,140	48,440	Contact Factory
144" w x 305" l	HPL	panel	RYUL14430536USS	8	36"	52) 24"w	39,515	40,485	45,765	51,065	Contact Factory
144" w x 80" l	HPL	panel	RYUL1448030USS	4	30"	16) 24"w	12,800	13,120	14,650	16,280	Contact Factory
144" w x 108" l	HPL	panel	RYUL14410830USS	4	30"	20) 24"w	15,485	15,835	18,165	20,235	Contact Factory
144" w x 130" l	HPL	panel	RYUL14413030USS	6	30"	24) 24"w	18,230	18,640	20,950	23,750	Contact Factory
144" w x 156" l	HPL	panel	RYUL14415630USS	6	30"	28) 24"w	21,425	21,935	24,505	27,165	Contact Factory
144" w x 180" l	HPL	panel	RYUL14418030USS	6	30"	32) 24"w	24,040	24,570	28,380	31,620	Contact Factory
144" w x 204" l	HPL	panel	RYUL14420430USS	6	30"	36) 24"w	26,555	27,125	30,875	34,175	Contact Factory
144" w x 230" l	HPL	panel	RYUL14423030USS	6	30"	40) 24"w	29,530	30,180	33,950	38,650	Contact Factory
144" w x 256" l	HPL	panel	RYUL14425630USS	6	30"	44) 24"w	32,005	32,655	36,425	41,125	Contact Factory
144" w x 280" l	HPL	panel	RYUL14428030USS	8	30"	48) 24"w	35,070	35,780	41,070	45,480	Contact Factory
144" w x 305" l	HPL	panel	RYUL14430530USS	8	30"	52) 24"w	37,605	38,375	43,575	48,075	Contact Factory
144" w x 80" l	HPL	panel	RYUL1448036USS	4	36"	16) 24"w	12,990	13,320	15,000	16,770	Contact Factory
144" w x 108" l	HPL	panel	RYUL14410836USS	4	36"	20) 24"w	15,835	16,215	18,315	20,455	Contact Factory
144" w x 130" l	HPL	panel	RYUL14413036USS	4	36"	24) 24"w	18,750	19,200	21,660	24,140	Contact Factory
144" w x 156" l	HPL	panel	RYUL14415636USS	4	36"	28) 24"w	21,595	22,105	25,225	27,845	Contact Factory
144" w x 180" l	HPL	panel	RYUL14418036USS	6	36"	32) 24"w	24,540	25,110	28,260	31,470	Contact Factory
144" w x 204" l	HPL	panel	RYUL14420436USS	6	36"	36) 24"w	27,855	28,545	32,375	36,265	Contact Factory
144" w x 230" l	HPL	panel	RYUL14423036USS	6	36"	40) 24"w	31,110	31,940	37,130	41,300	Contact Factory
144" w x 256" l	HPL	panel	RYUL14425636USS	6	36"	44) 24"w	31,495	34,415	39,605	43,775	Contact Factory
144" w x 280" l	HPL	panel	RYUL14428036USS	8	36"	48) 24"w	36,980	37,920	43,140	48,440	Contact Factory
144" w x 305" l	HPL	panel	RYUL14430536USS	8	36"	52) 24"w	39,515	40,485	45,765	51,065	Contact Factory

TABLE OPTIONS

POWER & A/V OPTIONS : [page 21- 38]

WIRE MANAGEMENT: [page 40 - 42]

ACCESSORIES: [pages 39 - 49 for options]

Supreme Options

Below are options that are available on all Supreme tables.



BASE OPTIONS: [page 45 for base heights]

Adjustable Height, push-pin (C and T Bases only)	
Table height range 26"-35" (C and T Bases)	
Table height range 29"-42" (C and T Bases)	
Table height range 26"-35" (X Base)	
Bar Height (42" overall table height - 40.75" base height), Stationary tables only.	
T, C and Y Bases	
TT-Base	
X-Base	
X4-Base	
Cafe' Height (36" overall table height - 34.75" base height), Stationary tables only.	
T, C and Y Bases	
TT-Base	
X-Base	
Custom Height (shorter than 27.75") Stationary only, call factory for folding and nesting	
T, C and Y Bases	
TT-Base	
X-Base	
Custom Height (taller than 27.75") Stationary only, call factory for nesting	
T, C and Y Bases	
TT-Base	
X-Base	
Casters, locking	
T, C and Y Bases	
TT-Base	
X-Base	
Polished Aluminum	
T, C and Y Bases	
TT-Base	
X-Base	
X4-Base	
Self-adjustable glides on base	
Metal to Metal threaded inserts. Factory Installed.	
TABLE OPTIONS	
Custom Stain for wood edges and veneers	
Premium Laminate	
Premium Edge-banding	

MODEL CODE

LIST PRICE

AH	\$160 per base
AHB	\$220 per base
AH	\$175 per base
BH	\$90 per base
BH	\$125 per base
BH	\$100 per base
BH	\$135 per base
CH	\$90 per base
CH	\$125 per base
CH	\$100 per base
SC	\$75 per base
SC	\$115 per base
SC	\$90 per base
TC	\$90 per base
TC	\$125 per base
TC	\$100 per base
CS	\$40 per base
CS	\$40 per base
CS	\$80 per base
CR	\$70 per base
CR	\$155 per base
CR	\$135 per base
CR	\$300 per base
SAGS	\$100 per base
TI	\$100 per table
UCS	\$600 per color
UCL	Contact Factory
UCE	Contact Factory
G (B/S)	\$20 per grommet
GV (B/S)	\$120 per grommet

POWER & AV OPTIONS : [page 21- 38]

Non-powered round ABS plastic Grommet (black or silver) | List location code on page 18
 Non-powered rectangle metal Grommet (black or silver) | List location code on page 18

MORE OPTIONS CONTINUED ON THE NEXT PAGE

Contact Factory FOR LAYOUT, SIZE OPTIONS AND SPECIFICATION ASSISTANCE

Example Base Product Code :						Finish Selections:		
<u>SP</u>	<u>T1</u>	<u>3060</u>	<u>RE</u>	<u>S</u>	<u>L3</u>	-	Options in	<u>BK</u>
Product	Base	Top	Top	Table	Top		Alphabetical	Base
Line	style	size	shape	function	edge		Order	Finish
								Top Laminate or
								Veneer Selection
								Edge
								Color

Supreme Options

Below are options that are available on all Supreme tables.



WIRE MANAGEMENT: [page 40 - 42]

- Customer specified hole in table top. Template required.
- Vertical ABS leg way for table base (black)
- Vertical ABS leg way for table base (silver)
- Vertical Laser cut holes in top and bottom of base (not available on X-base)
- Horizontal 4-channel ABS extruded raceway
- Horizontal conference wire management trough
- Horizontal J-channel that hangs off perforated metal modesty panel

CNC	\$250 set up fee per template
WR/B	\$25 per base
WR/S	\$25 per base
WB	\$50 per base
WH	\$80 per table
WT	\$475 per trough
WJ	\$210 per panel

ACCESSORIES: [pages 39 - 49 for options]

- Make 120"long (or shorter) tables into two pieces
- Add Radius Corners to table top. (Specify 1", 2", 3", 4", or 5" radius)
- Table gangers | List location code on page 18
(table gangers not available on L9 or wood edge profiles except L16 or W16)
- Steel Anti-sag bar
- Flat Plate, 3"x5"
- Fixed CPU holder width adjustment 2.75" x 5.25"
- Fixed CPU holder width adjustment 5.5" x 9.25"
- Swivel CPU holder width adjustment 2.75" x 5.25"
- Swivel CPU holder width adjustment 5.5" x 9.25"

FJ	\$300 per table
RC	\$100 per table
TG	\$135 per table

AS	\$100 per table
FP	\$20 per plate
C1	\$160 per holder
C2	\$160 per holder
C3	\$260 per holder
C4	\$260 per holder

MODESTY PANELS: 9" High straight panels [page 39]

Laminate (Model Code: ML)		Metal (Model Code: MM)	
30" panel	\$210 list price	30" panel	\$185 list price
36" panel	\$230 list price	36" panel	\$190 list price
42" panel	\$240 list price	42" panel	\$225 list price
48" panel	\$250 list price	48" panel	\$230 list price
60" panel	\$270 list price	60" panel	\$245 list price
72" panel	\$300 list price	72" panel	\$265 list price

Contact Factory FOR LAYOUT, SIZE OPTIONS AND SPECIFICATION ASSISTANCE

Example Base Product Code :						Finish Selections:				
<u>SP</u>	<u>T1</u>	<u>3060</u>	<u>RE</u>	<u>S</u>	<u>L3</u>	-	Options in	<u>BK</u>		<u>BK</u>
Product	Base	Top	Top	Table	Top		Alphabetical	Base	Top Laminate or	Edge
Line	style	size	shape	function	edge		Order	Finish	Veneer Selection	Color



Study Carrel
 12" high divider panels

1 PERSON CARRELS SHOWN

Single Sided

Laminate

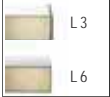

Seating Capacity	Carrel Size	Model Code:	Top QTY	Base QTY	Base Style / Base Spread	
1 person	24" x 30"	SPT12430RE S. (EDGE) —112PS	1	2	T - 20" / C - 22"	1905
2 person	24" x 60"	SPT12460RE S. (EDGE) —212PS	1	2	T - 20" / C - 22"	2940
3 person	24" x 90"	SPT12490RE S. (EDGE) —312PS	1	3	T - 20" / C - 22"	3755
4 person	24" x 120"	SPT124120RE S. (EDGE) —412PS	1	3	T - 20" / C - 22"	4855
5 person	24" x 150"	SPT124150RE S. (EDGE) —512PS	2	4	T - 20" / C - 22"	6340
6 person	24" x 180"	SPT124180RE S. (EDGE) —612PS	2	4	T - 20" / C - 22"	7230
1 person	30" x 30"	SPT13030RE S. (EDGE) —112PS	1	2	T - 26" / C - 27"	2070
2 person	30" x 60"	SPT13060RE S. (EDGE) —212PS	1	2	T - 26" / C - 27"	3175
3 person	30" x 90"	SPT13090RE S. (EDGE) —312PS	1	3	T - 26" / C - 27"	4065
4 person	30" x 120"	SPT130120RE S. (EDGE) —412PS	1	3	T - 26" / C - 27"	5225
5 person	30" x 150"	SPT130150RE S. (EDGE) —512PS	2	4	T - 26" / C - 27"	6830
6 person	30" x 180"	SPT130180RE S. (EDGE) —612PS	2	4	T - 26" / C - 27"	7775

Double Sided

Seating Capacity	Carrel Size	Model Code:	Top QTY	Base QTY	Base Style / Base Spread	
2 person	48" x 30"	SPT24830RE S. (EDGE) —212PD	1	2	TT - 34"	3375
4 person	48" x 60"	SPT24860RE S. (EDGE) —412PD	1	2	TT - 34"	5095
6 person	48" x 90"	SPT24890RE S. (EDGE) —612PD	1	3	TT - 34"	6885
8 person	48" x 120"	SPT248120RE S. (EDGE) —812PD	1	3	TT - 34"	8735
10 person	48" x 150"	SPT248150RE S. (EDGE) —1012PD	2	4	TT - 34"	11,545
12 person	48" x 180"	SPT248180RE S. (EDGE) —1212PD	2	5	TT - 34"	13,130
2 person	60" x 30"	SPT26030RE S. (EDGE) —212PD	1	2	TT - 40"	3465
4 person	60" x 60"	SPT26060RE S. (EDGE) —412PD	1	2	TT - 40"	5340
6 person	60" x 90"	SPT26090RE S. (EDGE) —612PD	1	3	TT - 40"	7415
8 person	60" x 120"	SPT260120RE S. (EDGE) —812PD	1	3	TT - 40"	9390
10 person	60" x 150"	SPT260150RE S. (EDGE) —1012PD	2	4	TT - 40"	12,340
12 person	60" x 180"	SPT260180RE S. (EDGE) —1212PD	2	4	TT - 40"	14,115



Testing Carrel

24" high divider panels

1 PERSON CARRELS
 SHOWN

Laminate

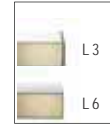

Single Sided

Seating Capacity	Carrel Size	Model Code:	Top QTY	Base QTY	Base Style / Base Spread	
1 person	24" x 30"	SPT12430RE S. (EDGE) —124PS	1	2	T - 20" / C - 22"	2085
2 person	24" x 60"	SPT12460RE S. (EDGE) —224PS	1	2	T - 20" / C - 22"	3195
3 person	24" x 90"	SPT12490RE S. (EDGE) —324PS	1	3	T - 20" / C - 22"	4660
4 person	24" x 120"	SPT124120RE S. (EDGE) —424PS	1	3	T - 20" / C - 22"	5720
5 person	24" x 150"	SPT124150RE S. (EDGE) —524PS	2	4	T - 20" / C - 22"	7445
6 person	24" x 180"	SPT124180RE S. (EDGE) —624PS	2	4	T - 20" / C - 22"	8570
1 person	30" x 30"	SPT13030RE S. (EDGE) —124PS	1	2	T - 26" / C - 27"	2240
2 person	30" x 60"	SPT13060RE S. (EDGE) —224PS	1	2	T - 26" / C - 27"	3410
3 person	30" x 90"	SPT13090RE S. (EDGE) —324PS	1	3	T - 26" / C - 27"	4940
4 person	30" x 120"	SPT130120RE S. (EDGE) —424PS	1	3	T - 26" / C - 27"	5865
5 person	30" x 150"	SPT130150RE S. (EDGE) —524PS	2	4	T - 26" / C - 27"	7890
6 person	30" x 180"	SPT130180RE S. (EDGE) —624PS	2	4	T - 26" / C - 27"	9060

Double Sided

Seating Capacity	Carrel Size	Model Code:	Top QTY	Base QTY	Base Style / Base Spread	
2 person	48" x 30"	SPT24830RE S. (EDGE) —224PD	1	2	TT - 34"	3675
4 person	48" x 60"	SPT24860RE S. (EDGE) —424PD	1	2	TT - 34"	5535
6 person	48" x 90"	SPT24890RE S. (EDGE) —624PD	1	3	TT - 34"	8030
8 person	48" x 120"	SPT248120RE S. (EDGE) —824PD	1	3	TT - 34"	9900
10 person	48" x 150"	SPT248150RE S. (EDGE) —1024PD	2	4	TT - 34"	13,005
12 person	48" x 180"	SPT248180RE S. (EDGE) —1224PD	2	4	TT - 34"	14,885
2 person	60" x 30"	SPT26030RE S. (EDGE) —224PD	1	2	TT - 40"	3735
4 person	60" x 60"	SPT26060RE S. (EDGE) —424PD	1	2	TT - 40"	5735
6 person	60" x 90"	SPT26090RE S. (EDGE) —624PD	1	3	TT - 40"	8500
8 person	60" x 120"	SPT260120RE S. (EDGE) —824PD	1	3	TT - 40"	10,110
10 person	60" x 150"	SPT260150RE S. (EDGE) —1024PD	2	4	TT - 40"	13,815
12 person	60" x 180"	SPT260180RE S. (EDGE) —1224PD	2	4	TT - 40"	15,770



How to Order:

Email orders to: sales@hi5furniture.com

1. Choose your base model
2. Add edge code to base model
3. Choose finishes
4. Select options to add to table
5. Select finishes of options



HALF ROUND
T style base

Table Size	Top Shape	Table Function	Model Code:	Base QTY	Base Spread	Base Style	Laminate
24 x 48	half round	stationary	SPT1 2448HR S	2	15"	T	L3 715
24 x 48	half round	nesting	SPT1 2448HR N	2	15"	T	L6 1170
30 x 60	half round	stationary	SPT1 3060HR S	2	20"	T	835
30 x 60	half round	nesting	SPT1 3060HR N	2	20"	T	1290
36 x 72	half round	stationary	SPT1 3672HR S	2	26"	T	1030
36 x 72	half round	nesting	SPT1 3672HR N	2	26"	T	1475

NOTE: Nesting tables come standard on locking casters.
 For C bases instead of T - substitute the SPT with SPC
 in the model code. List pricing is the same.



TRAPEZOID
T style base

24 x 60	trapezoid	stationary	SPT1 2460TZ S	2	15"	T	680
24 x 60	trapezoid	nesting	SPT1 2460TZ N	2	15"	T	1095
24 x 72	trapezoid	stationary	SPT1 2472TZ S	2	15"	T	805
24 x 72	trapezoid	nesting	SPT1 2472TZ N	2	15"	T	1220
30 x 60	trapezoid	stationary	SPT1 3060TZ S	2	20"	T	770
30 x 60	trapezoid	nesting	SPT1 3060TZ N	2	20"	T	1185
30 x 72	trapezoid	stationary	SPT1 3072TZ S	2	20"	T	915
30 x 72	trapezoid	nesting	SPT1 3072TZ N	2	20"	T	1330



CRSCENT
T style base

24 x 48	crescent	stationary	SPT1 2448CR S	2	20"	T	1090
24 x 48	crescent	nesting	SPT1 2448CR N	2	20"	T	1545
30 x 60	crescent	stationary	SPT1 3060CR S	2	26"	T	1440
30 x 60	crescent	nesting	SPT1 3060CR N	2	26"	T	1885
36 x 72	crescent	stationary	SPT1 3672CR S	2	26"	T	1795

BASE OPTIONS: [page 45 for base heights]

- Adjustable Height, push-pin (C and T Bases only)
- Table height range 26"-35"
- Table height range 29"-42"
- Bar Height (42" overall table height - 40.75" base height), Stationary tables only.
- Cafe' Height (36" overall table height - 34.75" base height), Stationary tables only.
- Casters, locking C and T-Base
- Polished Aluminum T-Base
- Self-adjustable glides on base

MODEL CODE	LIST PRICE
AH	\$160 per base
AHB	\$220 per base
BH	\$90 per base
CH	\$90 per base
CS	\$40 per base
CR	\$70 per base
SAGS	\$100 per base

POWER & A/V OPTIONS : [page 21 - 38]

- Non-powered round ABS plastic Grommet (black or silver) | List location code on page 18
- Non-powered rectangle metal Grommet (black or silver) | List location code on page 18

G (B/S)	\$20 per grommet
GV (B/S)	\$120 per grommet

WIRE MANAGEMENT: [page 40 - 42]

- Vertical ABS leg way for table base (black or silver)
- Vertical Laser cut holes in top and bottom of base (not available on X-base)
- Horizontal 4-channel ABS extruded raceway
- Horizontal J-channel that hangs off perforated metal modesty panel

WR B/S	\$25 per base
WB	\$50 per base
WH	\$80 per table
WJ	\$210 per panel

ACCESSORIES: [pages 39 - 49 for options]

- Table gangers | List location code on page 18
- (table gangers not available on L9 or wood edge profiles except L16 or W16)
- Steel Anti-sag bar

TG	\$135 per table
AS	\$100 per table

MODESTY PANELS: 9" High straight panels [page 39]

Laminate (Model Code: ML)		Metal (Model Code: MM)	
30" panel	\$210 list price	30" panel	\$185 list price
36" panel	\$230 list price	36" panel	\$190 list price
42" panel	\$240 list price	42" panel	\$225 list price
48" panel	\$250 list price	48" panel	\$230 list price
60" panel	\$270 list price	60" panel	\$245 list price
72" panel	\$300 list price	72" panel	\$265 list price



X style base

X4 style base

How to Order:

Email orders to: sales@hi5furniture.com

1. Choose your base model
2. Add edge code to base model
3. Choose finishes
4. Select options to add to table
5. Select finishes of options

NOTE: Nesting tables come standard on locking casters.
 For C bases instead of T - substitute the SPT with SPC in the model code. List pricing is the same.

Table Size	Top Shape	Table Function	Table Model Code:	Top QTY	Base QTY	Base Spread	Base Style
24"	round	stationary	SPX1 24RD S	1	1	20"	X
24"	round	nesting	SPX1 24RD N	1	1	20"	X
30"	round	stationary	SPX1 30RD S	1	1	26"	X
30"	round	nesting	SPX1 30RD N	1	1	26"	X
36"	round	stationary	SPX1 36RD S	1	1	26"	X
36"	round	nesting	SPX1 36RD N	1	1	26"	X
42"	round	stationary	SPX1 42RD S	1	1	32"	X
42"	round	nesting	SPX1 42RD N	1	1	32"	X
48"	round	stationary	SPX1 48RD S	1	1	38"	X
48"	round	nesting	SPX1 48RD N	1	1	38"	X
54"	round	stationary	SPX4 54RD S	1	1	38"	X4
60"	round	stationary	SPX4 60RD S	1	1	38"	X4
72"	round	stationary	SPX4 72RD S	2	1	46"	X4
84"	round	stationary	SPX4 84RD S	2	1	58"	X4
96"	round	stationary	SPX4 96RD S	2	1	58"	X4

Laminate & FormaWrap Tables

				L18	Veneer
				L20	
				L21	
				L22	
				L26	
				L33	
	L7			L34	Back Painted Glass
	L10			L35	
	L11	L17		L37	Solid Surfaces
L3	F1	F3			
	F2	F4			
L6					

BASE OPTIONS: [page 45 for base heights]

Bar Height (42" overall table height - 40.75" base height), Stationary tables only.

Cafe Height (36" overall table height - 34.75" base height), Stationary tables only.

Custom Height (shorter than 27.75") Stationary only, call factory for folding and nesting

Custom Height (taller than 27.75") Stationary only, call factory for nesting

Casters, locking

Polished Aluminum X-Base

Polished Aluminum X4-Base

Self-adjustable glides on base

Metal to Metal threaded inserts. Factory Installed.

MODEL CODE LIST PRICE

BH	\$100 per base
X4-BH	\$135 per base
CH	\$100 per base
SC	\$90 per base
TC	\$100 per base
CS	\$80 per base
CR	\$135 per base
CR	\$300 per base
SAGS	\$100 per base
TI	\$100 per table

TABLE OPTIONS

Custom Stain for wood edges and veneers

Premium Laminate

Premium Edge-banding

UCS	\$600 per color
UCL	Contact Factory
UCE	Contact Factory

POWER & A/V OPTIONS: [page 21-38]

Non-powered round ABS plastic Grommet (black or silver) | List location code on page 18

Non-powered rectangle metal Grommet (black or silver) | List location code on page 18

G (B/S)	\$20 per grommet
GV (B/S)	\$120 per grommet

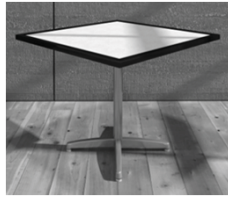

X style base



X4 style base

How to Order:

- Email orders to: sales@hi5furniture.com
1. Choose your base model
 2. Add edge code to base model
 3. Choose finishes
 4. Select options to add to table
 5. Select finishes of options

NOTE: Nesting tables come standard on locking casters.
 For C bases instead of T – substitute the SPT with SPC in the model code. List pricing is the same.

Table Size	Top Shape	Table Function	Table Model Code:	Base QTY	Base Spread	Base Style
24"	square	stationary	SPX1 24SQ S	1	20"	X
24"	square	nesting	SPX1 24SQ N	1	20"	X
30"	square	stationary	SPX1 30SQ S	1	26"	X
30"	square	nesting	SPX1 30SQ N	1	26"	X
36"	square	stationary	SPX1 36SQ S	1	26"	X
36"	square	nesting	SPX1 36SQ N	1	26"	X
42"	square	stationary	SPX1 42SQ S	1	33"	X
42"	square	nesting	SPX1 42SQ N	1	33"	X
48"	square	stationary	SPX1 48SQ S	1	38"	X
48"	square	nesting	SPX1 48SQ N	1	38"	X
54"	square	stationary	SPX4 54SQ S	1	38"	X4
60"	square	stationary	SPX4 60SQ S	1	38"	X4

Laminate & FormaWrap Tables

	L18	
	L20	
	L21	
	L22	
	L26	
	L33	
	L34	
	L35	
	L37	
	L7	
	L10	
	L11	
	L17	
	F1	
	F2	
	F3	
	F4	

Table Size	Top Shape	Table Function	Table Model Code:	Base QTY	Base Spread	Base Style	Table Price	Base Price	Table Price	Table Price	Table Price	Notes
52"	square	stationary	SPX1 52SQ S	1	20"	X	520	620	790	865	1265	Contact Factory
52"	square	nesting	SPX1 52SQ N	1	20"	X	850	960	1170	1265	1265	Contact Factory
30"	square	stationary	SPX1 30SQ S	1	26"	X	585	715	945	1050	1450	Contact Factory
30"	square	nesting	SPX1 30SQ N	1	26"	X	925	1055	1325	1450	1450	Contact Factory
36"	square	stationary	SPX1 36SQ S	1	26"	X	715	835	1125	1270	1675	Contact Factory
36"	square	nesting	SPX1 36SQ N	1	26"	X	1055	1175	1515	1675	1675	Contact Factory
42"	square	stationary	SPX1 42SQ S	1	33"	X	800	1055	1435	1620	2015	Contact Factory
42"	square	nesting	SPX1 42SQ N	1	33"	X	1135	1390	1810	2015	2015	Contact Factory
48"	square	stationary	SPX1 48SQ S	1	38"	X	855	1095	1555	1785	2180	Contact Factory
48"	square	nesting	SPX1 48SQ N	1	38"	X	1190	1430	1930	2180	2180	Contact Factory
54"	square	stationary	SPX4 54SQ S	1	38"	X4	1390	1750	2430	2760	2760	Contact Factory
60"	square	stationary	SPX4 60SQ S	1	38"	X4	1425	1815	2545	2900	2900	Contact Factory

BASE OPTIONS: [page 45 for base heights]

- Bar Height (42" overall table height - 40.75" base height), Stationary tables only.
- Cafe' Height (36" overall table height - 34.75" base height), Stationary tables only.
- Custom Height (shorter than 27.75") Stationary only, call factory for folding and nesting
- Custom Height (taller than 27.75") Stationary only, call factory for nesting
- Casters, locking
- Polished Aluminum X-Base
- Polished Aluminum X4-Base
- Self-adjustable glides on base
- Metal to Metal threaded inserts. Factory Installed.

MODEL CODE LIST PRICE

- BH \$100 per base
- X4-BH \$135 per base
- CH \$100 per base
- SC \$90 per base
- TC \$100 per base
- CS \$80 per base
- CR \$135 per base
- CR \$300 per base
- SAGS \$100 per base
- TI \$100 per table

TABLE OPTIONS

- Custom Stain for wood edges and veneers
- Premium Laminate
- Premium Edge-banding

- UCS \$600 per color
- UCL Contact Factory
- UCE Contact Factory

POWER & A/V OPTIONS: [page 21-38]

- Non-powered round ABS plastic Grommet (black or silver) | List location code on page 18
- Non-powered rectangle metal Grommet (black or silver) | List location code on page 18
- G (B/S) \$20 per grommet
- GV (B/S) \$120 per grommet

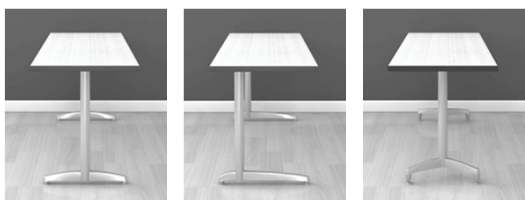

T style base C style base Y style base

How to Order:

Email orders to: sales@hi5furniture.com

1. Choose your base model
2. Add edge code to base model
3. Choose finishes
4. Select options to add to table
5. Select finishes of options

NOTE: Nesting tables come standard on locking casters.
For C bases instead of T - substitute the SPT with SPC in the model code.
List pricing is the same.

Laminate & FormaWrap Tables



Table Size	Top Shape	Table Function	Table Model Code:	Top QTY	Base QTY	Base Size	Base Style	Edge L	Edge F	Edge F	Edge L	Category
18 x 48	rectangle	stationary	SPT1 1848RE S	1	2	15	T	L3	F1	F3	L18	Veneer
18 x 48	rectangle	nesting	SPT1 1848RE N	1	2	15	T	L6	F2	F4	L20	Veneer
18 x 48	rectangle	stationary	SPY0 1848RE S	1	2	18	Y	L3	F1	F3	L21	Veneer
18 x 48	rectangle	stationary	SPY0 1848RE S	1	2	18	Y	L6	F2	F4	L22	Veneer
18 x 60	rectangle	stationary	SPT1 1860RE S	1	2	15	T	L3	F1	F3	L26	Veneer
18 x 60	rectangle	nesting	SPT1 1860RE N	1	2	15	T	L6	F2	F4	L33	Back Painted Glass
18 x 60	rectangle	stationary	SPY0 1860RE S	1	2	18	Y	L3	F1	F3	L34	Back Painted Glass
18 x 60	rectangle	stationary	SPY0 1860RE S	1	2	18	Y	L6	F2	F4	L35	Solid Surfaces
18 x 72	rectangle	stationary	SPT1 1872RE S	1	2	15	T	L3	F1	F3	L7	Veneer
18 x 72	rectangle	nesting	SPT1 1872RE N	1	2	15	T	L6	F2	F4	L10	Veneer
18 x 72	rectangle	stationary	SPY0 1872RE S	1	2	18	Y	L3	F1	F3	L11	Veneer
18 x 72	rectangle	stationary	SPY0 1872RE S	1	2	18	Y	L6	F2	F4	L17	Veneer
18 x 84	rectangle	stationary	SPT1 1884RE S	1	2	15	T	L3	F1	F3	L3	Veneer
18 x 84	rectangle	stationary	SPY0 1884RE S	1	2	18	Y	L6	F2	F4	L37	Solid Surfaces
18 x 96	rectangle	stationary	SPT1 1896RE S	1	2	15	T	L3	F1	F3	L3	Veneer
18 x 96	rectangle	stationary	SPY0 1896RE S	1	2	18	Y	L6	F2	F4	L37	Solid Surfaces

BASE OPTIONS: [page 45 for base heights]

- Adding a third base for more support
- Adjustable Height, push-pin (C and T Bases only)
- Table height range 26"-35"
- Table height range 29"-42"
- Bar Height (42" overall table height - 40.75" base height), Stationary tables only.
- Cafe' Height (36" overall table height - 34.75" base height), Stationary tables only.
- Casters, locking C, T and Y Bases
- Polished Aluminum C, T and Y Bases
- Self-adjustable glides on base

MODEL CODE	LIST PRICE
ABHR	\$315 per base
AH	\$160 per base
AHB	\$220 per base
BH	\$90 per base
CH	\$90 per base
CS	\$40 per base
CR	\$70 per base
SAGS	\$100 per base

POWER & AV OPTIONS : [page 21- 38]

- Non-powered round ABS plastic Grommet (black or silver) | List location code on page 18
- Non-powered rectangle metal Grommet (black or silver) | List location code on page 18

G (B/S)	\$20 per grommet
GV (B/S)	\$120 per grommet

WIRE MANAGEMENT: [page 40 - 42]

- Vertical ABS leg way for table base (black or silver)
- Vertical Laser cut holes in top and bottom of base (not available on X-base)
- Horizontal 4-channel ABS extruded raceway
- Horizontal J-channel that hangs off perforated metal modesty panel

WR B/S	\$25 per base
WB	\$50 per base
WH	\$80 per table
WJ	\$210 per panel

ACCESSORIES: [pages 39 - 49 for options]

- Table gangers | List location code on page 18
- (table gangers not available on L9 or wood edge profiles except L16 or W16)
- Steel Anti-sag bar

TG	\$135 per table
AS	\$100 per table

MODESTY PANELS: 9" High straight panels [page 39]

Laminate (Model Code: ML)		Metal (Model Code: MM)	
30" panel	\$210 list price	30" panel	\$185 list price
36" panel	\$230 list price	36" panel	\$190 list price
42" panel	\$240 list price	42" panel	\$225 list price
48" panel	\$250 list price	48" panel	\$230 list price
60" panel	\$270 list price	60" panel	\$245 list price
72" panel	\$300 list price	72" panel	\$265 list price



T style base

C style base

Y style base

- How to Order:**
 Email orders to: sales@hi5furniture.com
 1. Choose your base model
 2. Add edge code to base model
 3. Choose finishes
 4. Select options to add to table
 5. Select finishes of options

NOTE: Nesting tables come standard on locking casters.
 For C bases instead of T - substitute the SPT with SPC in the model code.
 List pricing is the same.
 24" deep tables with a Y base do not include stretchers

Table Size	Top Shape	Table Function	Model Code:	Top QTY	Base QTY	Base Size	Base Style
24 x 48	rectangle	stationary	SPT1 2448RE S	1	2	20	T
24 x 48	rectangle	stationary	SPY0 2448RE S	1	2	18"	Y
24 x 48	rectangle	nesting	SPT1 2448RE N	1	2	20	T
24 x 60	rectangle	stationary	SPT1 2460RE S	1	2	20"	T
24 x 60	rectangle	stationary	SPY0 2460RE S	1	2	18"	Y
24 x 60	rectangle	folding	SPT1 2460RE F	1	2	20	T
24 x 60	rectangle	nesting	SPT1 2460RE N	1	2	20	T
24 x 72	rectangle	stationary	SPT1 2472RE S	1	2	20	T
24 x 72	rectangle	stationary	SPY0 2472RE S	1	2	18"	Y
24 x 72	rectangle	folding	SPT1 2472RE F	1	2	20	T
24 x 72	rectangle	nesting	SPT1 2472RE N	1	2	20	T
24 x 84	rectangle	stationary	SPT1 2484RE S	1	2	20	T
24 x 84	rectangle	stationary	SPY0 2484RE S	1	2	18"	Y
24 x 84	rectangle	folding	SPT1 2484RE F	1	2	20	T
24 x 96	rectangle	stationary	SPT1 2496RE S	1	2	20	T
24 x 96	rectangle	stationary	SPY0 2496RE S	1	2	18"	Y
24 x 96	rectangle	folding	SPT1 2496RE F	1	2	20	T

Laminate & FormaWrap Tables

L3	L6	L7	L10	L11	L17	L18	L20	L21	L22	L26	L33	L34	L35	L37
----	----	----	-----	-----	-----	-----	-----	-----	-----	-----	-----	-----	-----	-----

Model Code	Price 1	Price 2	Price 3	Price 4	Finish
715	865	1145	1275	Contact	Factory
870	930	1125	1345	Contact	Factory
1170	1320	1650	1815	Contact	Factory
755	930	1260	1420	Contact	Factory
940	1005	1270	1540	Contact	Factory
1060	1240	1610	1785	Contact	Factory
1210	1385	1775	1960	Contact	Factory
795	1000	1370	1555	Contact	Factory
1000	1080	1415	1750	Contact	Factory
1100	1310	1720	1920	Contact	Factory
1250	1460	1890	2095	Contact	Factory
875	1065	1495	1700	Contact	Factory
1035	1115	1700	2135	Contact	Factory
1180	1375	1835	2065	Contact	Factory
885	1140	1610	1840	Contact	Factory
1040	1135	1710	2145	Contact	Factory
1195	1445	1955	2205	Contact	Factory

BASE OPTIONS: [page 45 for base heights]

- Adding a third base for more support
- Adjustable Height, push-pin (C and T Bases only)
- Table height range 26"-35"
- Table height range 29"-42"
- Bar Height (42" overall table height - 40.75" base height), Stationary tables only.
- Cafe' Height (36" overall table height - 34.75" base height), Stationary tables only.
- Casters, locking C, T and Y Bases
- Polished Aluminum C, T and Y Bases
- Self-adjustable glides on base

MODEL CODE LIST PRICE

- ABHR \$315 per base
- AH \$160 per base
- AHB \$220 per base
- BH \$90 per base
- CH \$90 per base
- CS \$40 per base
- CR \$70 per base
- SAGS \$100 per base

POWER & AV OPTIONS: [page 21- 38]

- Non-powered round ABS plastic Grommet (black or silver) | List location code on page 18
- Non-powered rectangle metal Grommet (black or silver) | List location code on page 18

- G (B/S) \$20 per grommet
- GV (B/S) \$120 per grommet

WIRE MANAGEMENT: [page 40 - 42]

- Vertical ABS leg way for table base (black or silver)
- Vertical Laser cut holes in top and bottom of base (not available on X-base)
- Horizontal 4-channel ABS extruded raceway
- Horizontal J-channel that hangs off perforated metal modesty panel

- WR B/S \$25 per base
- WB \$50 per base
- WH \$80 per table
- WJ \$210 per panel

ACCESSORIES: [pages 39 - 49 for options]

- Table gangers | List location code on page 18 (table gangers not available on L9 or wood edge profiles except L16 or W16)
- Steel Anti-sag bar

- TG \$135 per table
- AS \$100 per table

MODESTY PANELS: 9" High straight panels [page 39]

Laminate (Model Code: ML)		Metal (Model Code: MM)	
30" panel	\$210 list price	30" panel	\$185 list price
36" panel	\$230 list price	36" panel	\$190 list price
42" panel	\$240 list price	42" panel	\$225 list price
48" panel	\$250 list price	48" panel	\$230 list price
60" panel	\$270 list price	60" panel	\$245 list price
72" panel	\$300 list price	72" panel	\$265 list price

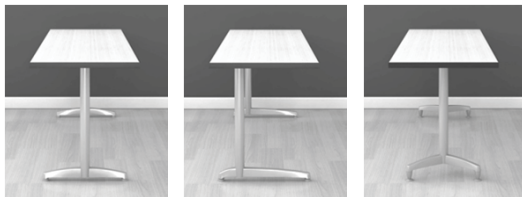

T style base C style base Y style base

How to Order:

Email orders to: sales@hi5furniture.com

1. Choose your base model
2. Add edge code to base model
3. Choose finishes
4. Select options to add to table
5. Select finishes of options

NOTE: Nesting tables come standard on locking casters.

-For C bases instead of T - substitute the SPT with SPC in the model code.
 List pricing is the same.

-Replace the ? with an RT (for Racetrack) or a BT (for Boat) to complete the model code. [ex. SPT1 3060BT S - for a 30x60 boat]

Laminate & FormaWrap Tables

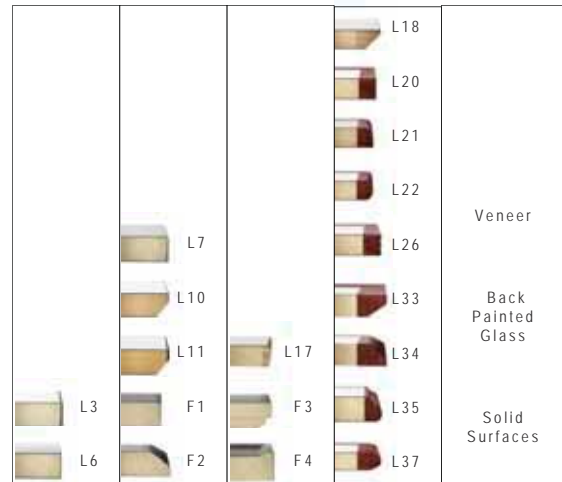

Table Size	Top Shape	Table Function	Table Model Code:	Top QTY	Base QTY	Base Size	Base Style					
30 x 48	rectangle	stationary	SPT1 3048RE S	1	2	26	T	780	955	1285	1445	Contact Factory
30 x 48	rectangle	stationary	SPY0 3048RE S	1	2	23	Y	980	1045	1300	1590	Contact Factory
30 x 48	rectangle	nesting	SPT1 3048RE N	1	2	26	T	1225	1400	1780	1970	Contact Factory
30 x 60	rectangle	stationary	SPT1 3060RE S	1	2	26	T	825	1040	1430	1620	Contact Factory
30 x 60	rectangle	stationary	SPY0 3060RE S	1	2	23	Y	1060	1135	1475	1840	Contact Factory
30 x 60	racetrack or boat	stationary	SPT1 3060?T S	1	2	26	T	1045	1120	1520	1710	Contact Factory
30 x 60	racetrack or boat	stationary	SPY1 3060?T S	1	2	23	Y	1060	1135	1865	2090	Contact Factory
30 x 60	rectangle	folding	SPT1 3060RE F	1	2	26	T	1120	1335	1765	1970	Contact Factory
30 x 60	rectangle	nesting	SPT1 3060RE N	1	2	26	T	1270	1485	1925	2145	Contact Factory
30 x 72	rectangle	stationary	SPT1 3072RE S	1	2	26	T	870	1125	1575	1795	Contact Factory
30 x 72	rectangle	stationary	SPY0 3072RE S	1	2	23	Y	1140	1225	1650	2100	Contact Factory
30 x 72	racetrack or boat	stationary	SPT1 3072?T S	1	2	26	T	1090	1205	1665	1885	Contact Factory
30 x 72	racetrack or boat	stationary	SPY1 3072?T S	1	2	23	Y	1140	1225	2040	2350	Contact Factory
30 x 72	rectangle	folding	SPT1 3072RE F	1	2	26	T	1165	1425	1905	2145	Contact Factory
30 x 72	rectangle	nesting	SPT1 3072RE N	1	2	26	T	1315	1575	2075	2325	Contact Factory
30 x 84	rectangle	stationary	SPT1 3084RE S	1	2	26	T	970	1210	1720	1965	Contact Factory
30 x 84	rectangle	stationary	SPY0 3084RE S	1	2	23	Y	1165	1255	1995	2580	Contact Factory
30 x 84	racetrack or boat	stationary	SPT1 3084?T S	1	2	26	T	1190	1290	1810	2065	Contact Factory
30 x 84	racetrack or boat	stationary	SPY1 3084?T S	1	2	23	Y	1165	1255	2395	2830	Contact Factory
30 x 84	rectangle	folding	SPT1 3084RE F	1	2	26	T	1265	1510	2050	2315	Contact Factory
30 x 96	rectangle	stationary	SPT1 3096RE S	1	2	26	T	980	1295	2765	2140	Contact Factory
30 x 96	rectangle	stationary	SPY0 3096RE S	1	2	23	Y	1175	1275	2000	2600	Contact Factory
30 x 96	racetrack or boat	stationary	SPT1 3096?T S	1	2	26	T	1200	1370	1950	2240	Contact Factory
30 x 96	racetrack or boat	stationary	SPY1 3096?T S	1	2	23	Y	1175	1275	2400	2880	Contact Factory
30 x 96	rectangle	folding	SPT1 3096RE F	1	2	26	T	1275	1590	2190	2490	Contact Factory

BASE OPTIONS: [page 45 for base heights]

- Adding a third base for more support
- Adjustable Height, push-pin (C and T Bases only)
Table height range 26"-35"
- Table height range 29"-42"
- Bar Height (42" overall table height - 40.75" base height), Stationary tables only.
- Cafe' Height (36" overall table height - 34.75" base height), Stationary tables only.
- Casters, locking C, T and Y Bases
- Polished Aluminum C, T and Y Bases
- Self-adjustable glides on base

MODEL CODE

- ABHR \$315 per base
- AH \$160 per base
- AHB \$220 per base
- BH \$90 per base
- CH \$90 per base
- CS \$40 per base
- CR \$70 per base
- SAGS \$100 per base

LIST PRICE

POWER & A/V OPTIONS: [page 21- 38]

- Non-powered round ABS plastic Grommet (black or silver) | List location code on page 18
- Non-powered rectangle metal Grommet (black or silver) | List location code on page 18

- G (B/S) \$20 per grommet
- GV (B/S) \$120 per grommet

WIRE MANAGEMENT: [page 40 - 42]

- Vertical ABS leg way for table base (black or silver)
- Vertical Laser cut holes in top and bottom of base (not available on X-base)
- Horizontal 4-channel ABS extruded raceway
- Horizontal J-channel that hangs off perforated metal modesty panel

- WR B/S \$25 per base
- WB \$50 per base
- WH \$80 per table
- WJ \$210 per panel

ACCESSORIES: [pages 39 - 49 for options]

- Table gangers | List location code on page 18
(table gangers not available on L9 or wood edge profiles except L16 or W16)
- Steel Anti-sag bar

- TG \$135 per table
- AS \$100 per table

MODESTY PANELS: 9" High straight panels [page 39]

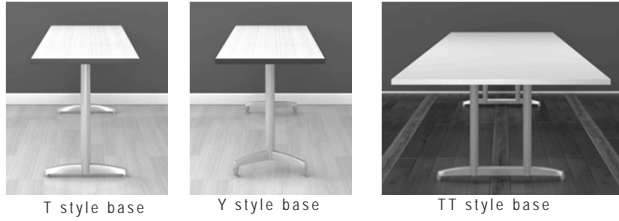

T style base

Y style base

TT style base

How to Order:

Email orders to: sales@hi5furniture.com

1. Choose your base model
2. Add edge code to base model
3. Choose finishes
4. Select options to add to table
5. Select finishes of options

NOTE: Nesting tables come standard on locking casters.

-For C bases instead of T - substitute the SPT with SPC in the model code.
 List pricing is the same.

-For 36" deep tables with a Y base include a stretcher

-Replace the ? with an RT (for Racetrack) or a BT (for Boat) to complete the model code. [ex. SPT1 3060BT S - for a 30x60 boat]

Laminate & FormaWrap Tables

				L18	
				L20	
				L21	
				L22	
				L26	Veneer
				L33	Back Painted Glass
				L34	
				L35	Solid Surfaces
				L37	
L7					
L10					
L11			L17		
L3					
L6	F1	F2	F3	F4	

Table Size	Top Shape	Table Function	Model Code:	Top QTY	Base QTY	Base Size	Base Style						
36 x 48	rectangle	stationary	SPT1 3648RE S	1	2	26	T	995	1135	1525	1710	Contact Factory	
36 x 48	rectangle	stationary	SPY1 3648RE S	1	2	33	Y	1570	1640	1955	2305	Contact Factory	
36 x 60	rectangle	stationary	SPT1 3660RE S	1	2	26	T	1060	1235	1695	1915	Contact Factory	
36 x 60	rectangle	stationary	SPY1 3660RE S	1	2	33	Y	1675	1755	2175	2610	Contact Factory	
36 x 60	racetrack or boat	stationary	SPT1 3660?T S	1	2	26	T	1280	1310	1780	2010	Contact Factory	
36 x 60	racetrack or boat	stationary	SPY1 3660?T S	1	2	33	Y	1675	1755	2565	2860	Contact Factory	
36 x 72	rectangle	stationary	SPT1 3672RE S	1	2	26	T	1130	1330	1860	2120	Contact Factory	
36 x 72	rectangle	stationary	SPY1 3672RE S	1	2	33	Y	1770	1865	2390	2925	Contact Factory	
36 x 72	racetrack or boat	stationary	SPT1 3672?T S	1	2	26	T	1350	1410	1950	2210	Contact Factory	
36 x 72	racetrack or boat	stationary	SPY1 3672?T S	1	2	33	Y	1770	1865	2780	3175	Contact Factory	
36 x 84	rectangle	stationary	SPT2 3684RE S	1	2	34	TT	1470	1610	2240	2545	Contact Factory	
36 x 84	rectangle	stationary	SPY1 3684RE S	1	2	33	Y	1965	2090	2785	3490	Contact Factory	
36 x 84	racetrack or boat	stationary	SPT2 3684?T S	1	2	34	TT	1690	1695	2325	2660	Contact Factory	
36 x 84	racetrack or boat	stationary	SPY1 3684?T S	1	2	33	Y	1965	2090	3185	3740	Contact Factory	
36 x 96	rectangle	stationary	SPT2 3696RE S	1	2	34	TT	1480	1710	2410	2750	Contact Factory	
36 x 96	rectangle	stationary	SPY1 3696RE S	1	2	33	Y	2070	2200	2905	3610	Contact Factory	
36 x 96	racetrack or boat	stationary	SPT2 3696?T S	1	2	34	TT	1700	1815	2505	2845	Contact Factory	
36 x 96	racetrack or boat	stationary	SPY1 3696?T S	1	2	33	Y	2070	2200	3300	3845	Contact Factory	
36 x 120	rectangle	stationary	SPT2 36120RE S	1	3	34	TT	2005	2305	3195	3630	Contact Factory	

BASE OPTIONS: [page 45 for base heights]

- Adding a third base for more support
- Adjustable Height, push-pin (C and T Bases only)
 Table height range 26"-35"
 Table height range 29"-42"
- Bar Height (42" overall table height - 40.75" base height), Stationary tables only.
- Cafe' Height (36" overall table height - 34.75" base height), Stationary tables only.
- Casters, locking C, T and Y Bases
- Polished Aluminum C, T and Y Bases
- Self-adjustable glides on base

MODEL CODE

- ABHR \$315 per base
- AH \$160 per base
- AHB \$220 per base
- BH \$90 per base
- CH \$90 per base
- CS \$40 per base
- CR \$70 per base
- SAGS \$100 per base

LIST PRICE

POWER & AV OPTIONS: [page 21-38]

- Non-powered round ABS plastic Grommet (black or silver) | List location code on page 18
- Non-powered rectangle metal Grommet (black or silver) | List location code on page 18

- G (B/S) \$20 per grommet
- GV (B/S) \$120 per grommet

WIRE MANAGEMENT: [page 40 - 42]

- Vertical ABS leg way for table base (black or silver)
- Vertical Laser cut holes in top and bottom of base (not available on X-base)
- Horizontal 4-channel ABS extruded raceway
- Horizontal J-channel that hangs off perforated metal modesty panel

- WR B/S \$25 per base
- WB \$50 per base
- WH \$80 per table
- WJ \$210 per panel

ACCESSORIES: [pages 39 - 49 for options]

- Table gangers | List location code on page 18
 (table gangers not available on L9 or wood edge profiles except L16 or W16)
- Steel Anti-sag bar

- TG \$135 per table
- AS \$100 per table

MODESTY PANELS: 9" High straight panels [page 39]



Y style base

TT style base

How to Order:

Email orders to: sales@hi5furniture.com

1. Choose your base model
2. Add edge code to base model
3. Choose finishes
4. Select options to add to table
5. Select finishes of options

NOTE: Nesting tables come standard on locking casters.

-For C bases instead of T - substitute the SPT with SPC in the model code. List pricing is the same.

-For 42" wide table instead of 48" wide - substitute the SPT248 with SPT242 in the model code. List pricing is the same.

-For 42" deep tables with a Y base include a stretcher

-Replace the ? with an RT (for Racetrack) or a BT (for Boat) to complete the model code. [ex. SPT1 3060BT S - for a 30x60 boat]

Table Size	Top Shape	Table Function	Table Model Code:	Top QTY	Base QTY	Base Size	Base Style					
48 x 60	rectangle	stationary	SPT2 4860RE S	1	2	34	TT	1260	1575	2175	2465	Contact Factory
48 x 60	rectangle	stationary	SPY1 4860RE S	1	2	33	Y	1665	1750	2545	3115	Contact Factory
48 x 60	racetrack or boat	stationary	SPT2 4860?T S	1	2	34	TT	1480	1655	2255	2555	Contact Factory
48 x 60	racetrack or boat	stationary	SPY1 4860?T S	1	2	33	Y	1760	1860	2825	3370	Contact Factory
48 x 72	rectangle	stationary	SPT2 4872RE S	1	2	34	TT	1325	1700	2390	2730	Contact Factory
48 x 72	rectangle	stationary	SPY1 4872RE S	1	2	33	Y	1765	1865	2840	3530	Contact Factory
48 x 72	racetrack or boat	stationary	SPT2 4872?T S	1	2	34	TT	1545	1785	2485	2830	Contact Factory
48 x 72	racetrack or boat	stationary	SPY1 4872?T S	1	2	33	Y	1855	1965	3130	3780	Contact Factory
48 x 84	rectangle	stationary	SPT2 4884RE S	1	2	34	TT	1480	2540	3410	3845	Contact Factory
48 x 84	rectangle	stationary	SPY1 4884RE S	1	2	33	Y	1985	2115	3420	4345	Contact Factory
48 x 84	racetrack or boat	stationary	SPT2 4884?T S	1	2	34	TT	1700	2625	3495	3930	Contact Factory
48 x 84	racetrack or boat	stationary	SPY1 4884?T S	1	2	33	Y	2070	2210	3725	4845	Contact Factory
48 x 96	rectangle	stationary	SPT2 4896RE S	1	2	34	TT	1570	2665	3635	4110	Contact Factory
48 x 96	rectangle	stationary	SPY1 4896RE S	1	2	33	Y	2025	2160	3450	4380	Contact Factory
48 x 96	racetrack or boat	stationary	SPT2 4896?T S	1	2	34	TT	1710	2750	3550	3940	Contact Factory
48 x 96	racetrack or boat	stationary	SPY1 4896?T S	1	2	33	Y	2100	2245	3760	4880	Contact Factory
48 x 120	rectangle	stationary	SPT2 48120RE S	1	3	34	TT	2030	3320	4520	5120	Contact Factory
48 x 120	rectangle	stationary	SPY1 48120RE S	1	3	33	Y	2265	2425	4205	5235	Contact Factory
48 x 120	racetrack or boat	stationary	SPT2 48120?T S	1	3	34	TT	2250	3400	4610	5210	Contact Factory
48 x 120	racetrack or boat	stationary	SPY1 48120?T S	1	3	33	Y	2345	2515	4645	5745	Contact Factory
48 x 144	rectangle	stationary	SPT2 48144RE S	2	4	34	TT	2880	4075	5525	6240	Contact Factory
48 x 144	racetrack or boat	stationary	SPT2 48144?T S	2	4	34	TT	3100	4160	5620	6340	Contact Factory
48 x 168	rectangle	stationary	SPT2 48168RE S	2	4	34	TT	2900	4495	6285	7180	Contact Factory
48 x 168	racetrack or boat	stationary	SPT2 48168?T S	2	4	34	TT	3120	4565	6355	7250	Contact Factory
48 x 192	rectangle	stationary	SPT2 48192RE S	2	4	34	TT	2920	4585	6405	7315	Contact Factory
48 x 192	racetrack or boat	stationary	SPT2 48192?T S	2	4	34	TT	3140	4665	6495	7405	Contact Factory

Laminate & FormaWrap Tables

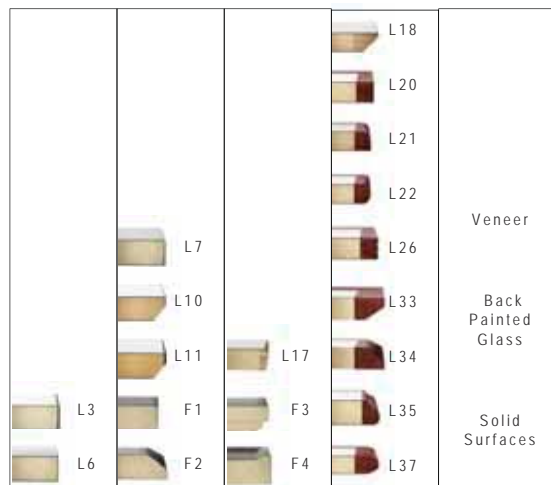

Veneer

Back Painted Glass

Solid Surfaces

BASE OPTIONS: [page 45 for base heights]

- Bar Height (42" overall table height - 40.75" base height), Stationary tables only.
- Cafe' Height (36" overall table height - 34.75" base height), Stationary tables only. TT-Base
- Custom Height (shorter than 27.75") Stationary only, call factory for folding and nesting TT-Base
- Custom Height (taller than 27.75") Stationary only, call factory for nesting TT-Base
- Casters, locking TT and Y base
- Polished Aluminum TT-Base and Y base
- Self-adjustable glides on base

MODEL CODE LIST PRICE

- BH \$125 per base
- CH \$125 per base
- SC \$115 per base
- TC \$125 per base
- CS \$40 per base
- CR \$155 per base
- SAGS \$100 per base

TABLE OPTIONS

- Custom Stain for wood edges and veneers

- UCS \$600 per color

POWER & A/V OPTIONS: [page 21- 38]

- Non-powered round ABS plastic Grommet (black or silver) | List location code on page 18
- Non-powered rectangle metal Grommet (black or silver) | List location code on page 18

- G (B/S) \$20 per grommet
- GV (B/S) \$120 per grommet

WIRE MANAGEMENT: [page 40 - 42]

- Customer specified hole in table top. Template required.
- Vertical ABS leg way for table base (black)
- Vertical ABS leg way for table base (silver)
- Vertical Laser cut holes in top and bottom of base (not available on X-base)
- Horizontal 4-channel ABS extruded raceway
- Horizontal conference wire management trough

- CNC \$250 set up fee per template
- WR/B \$25 per base
- WR/S \$25 per base
- WB \$50 per base
- WH \$80 per table
- WT \$475 per trough

ACCESSORIES: [pages 39 - 49 for options]



TT style base

How to Order:

Email orders to: sales@hi5furniture.com

1. Choose your base model
2. Add edge code to base model
3. Choose finishes
4. Select options to add to table
5. Select finishes of options

NOTE: Nesting tables come standard on locking casters.
 -For C bases instead of T - substitute the SPT with SPC in the model code. List pricing is the same.
 -For 42" deep tables with a Y base include a stretcher
 -Replace the ? with an RT (for Racetrack) or a BT (for Boat) to complete the model code. [ex. SPT1 3060BT S - for a 30x60 boat]

Laminate & FormaWrap Tables



Table Size	Top Shape	Table Function	Model Code:	Top QTY	Base QTY	Base Size	Base Style																
60 x 72	rectangle	stationary	SPT2 6072RE S	1	2	40	TT	L3	L6	L7	L10	L11	L17	L18	L20	L21	L22	L26	L33	L34	L35	L37	Contact Factory
60 x 72	racetrack or boat	stationary	SPT2 6072?T S	1	2	40	TT																Contact Factory
60 x 84	rectangle	stationary	SPT2 6084RE S	1	2	40	TT																Contact Factory
60 x 84	racetrack or boat	stationary	SPT2 6084?T S	1	2	40	TT																Contact Factory
60 x 96	rectangle	stationary	SPT2 6096RE S	1	2	40	TT																Contact Factory
60 x 96	racetrack or boat	stationary	SPT2 6096?T S	1	2	40	TT																Contact Factory
60 x 120	rectangle	stationary	SPT2 60120RE S	1	3	40	TT																Contact Factory
60 x 120	racetrack or boat	stationary	SPT2 60120?T S	1	3	40	TT																Contact Factory
60 x 144	rectangle	stationary	SPT2 60144RE S	2	4	40	TT																Contact Factory
60 x 144	racetrack or boat	stationary	SPT2 60144?T S	2	4	40	TT																Contact Factory
60 x 168	rectangle	stationary	SPT2 60168RE S	2	4	40	TT																Contact Factory
60 x 168	racetrack or boat	stationary	SPT2 60168?T S	2	4	40	TT																Contact Factory
60 x 192	rectangle	stationary	SPT2 60192RE S	2	4	40	TT																Contact Factory
60 x 192	racetrack or boat	stationary	SPT2 60192?T S	2	4	40	TT																Contact Factory

BASE OPTIONS: [page 45 for base heights]

- Bar Height (42" overall table height - 40.75" base height), Stationary tables only.
- Cafe' Height (36" overall table height - 34.75" base height), Stationary tables only. TT-Base
- Custom Height (shorter than 27.75") Stationary only, call factory for folding and nesting TT-Base
- Custom Height (taller than 27.75") Stationary only, call factory for nesting TT-Base
- Casters, locking TT-Base
- Polished Aluminum TT-Base
- Self-adjustable glides on base
- Metal to Metal threaded inserts. Factory Installed.

MODEL CODE	LIST PRICE
BH	\$125 per base
CH	\$125 per base
SC	\$115 per base
TC	\$125 per base
CS	\$40 per base
CR	\$155 per base
SAGS	\$100 per base
TI	\$100 per table

TABLE OPTIONS

Custom Stain for wood edges and veneers	UCS	\$600 per color
Premium Laminate	UCL	Contact Factory
Premium Edge-banding	UCE	Contact Factory

POWER & AVV OPTIONS : [page 21- 38]

Non-powered round ABS plastic Grommet (black or silver) List location code on page 18	G (B/S)	\$20 per grommet
Non-powered rectangle metal Grommet (black or silver) List location code on page 18	GV (B/S)	\$120 per grommet

WIRE MANAGEMENT: [page 40 - 42]

Customer specified hole in table top. Template required.	CNC	\$250 set up fee per template
Vertical ABS leg way for table base (black)	WR/B	\$25 per base
Vertical ABS leg way for table base (silver)	WR/S	\$25 per base
Vertical Laser cut holes in top and bottom of base (not available on X-base)	WB	\$50 per base
Horizontal 4-channel ABS extruded raceway	WH	\$80 per table
Horizontal conference wire management trough	WT	\$475 per trough

ACCESSORIES: [pages 39 - 49 for options]

Make 120"long (or shorter) tables into two pieces	FJ	\$300 per table
---	----	-----------------

UNION CONTEMPORARY

COLLECTION

Union Options

Below are options that are available on all Union tables.



BASE OPTIONS: [page 45 for base heights]

TABLE OPTIONS

- Premium Laminate
- Accent laminate table bases and underside of table top – standard laminate
- Accent laminate table bases and underside of table top – premium laminate

POWER & A/V OPTIONS : [page 21- 38]

- Non-powered round ABS plastic Grommet (black or silver) | For location code see page 19
- Non-powered rectangle metal Grommet (black or silver) | For location code see page 19

WIRE MANAGEMENT: [page 40 - 42]

- Customer specified hole cut into top
- 36" long Horizontal 4 track Extruded Raceway
- Horizontal conference raceway
- Vertical wire management - 4 track Extruded Raceway

MODEL CODE

LIST PRICE

UCL		Contact Factory
UCA	5% upcharge on list price on a basic table	
UCA		Contact Factory
G (B/S)		\$20 per grommet
GV (B/S)		\$120 per grommet
CNC		\$250 set up fee per template
WH		\$80 per piece
WT		\$475 per table
WM		\$100 list per base



**Model Code:
WM**

Contact Factory FOR LAYOUT, SIZE OPTIONS AND SPECIFICATION ASSISTANCE

Example Base Product Code :						Finish Selections:				
<u>UN</u>	<u>TL</u>	<u>3060</u>	<u>29</u>	<u>RE S</u>	<u>L8</u>	-	Options in	<u>BK</u>	<u>7909-60</u>	<u>BK</u>
Product	Base	Top	Table	Shape	Top		Alphabetical Order	Base	Top Laminate or	Edge
Line	style	size	Height	Function	edge			Finish	Veneer Selection	Color



How to Order:

Email orders to: sales@hi5furniture.com

1. Choose your base model
2. Add edge code to base model
3. Choose finishes
4. Select options to add to table
5. Select finishes of options



Table Size	Top Shape	Base Material	Base Model Code:	Base QTY	Base Size	Base Style	L8 edge 2" thick top	Price with Color Core
24 x 60 x 29 high	rectangle	HPL	UNTL 246029RE S	2	24"	panel	2570	3340
24 x 60 x 36 high	rectangle	HPL	UNTL 246036RE S	2	24"	panel	2755	3585
24 x 60 x 42 high	rectangle	HPL	UNTL 246042RE S	2	24"	panel	3130	4065
24 x 60 x 29 high	rectangle	Veneer	UNTV 246029RE S	2	24"	panel	6500	N/A
24 x 60 x 36 high	rectangle	Veneer	UNTV 246036RE S	2	24"	panel	7075	N/A
24 x 60 x 42 high	rectangle	Veneer	UNTV 246042RE S	2	24"	panel	8235	N/A
24 x 72 x 29 high	rectangle	HPL	UNTL 247229RE S	2	24"	panel	2755	3585
24 x 72 x 36 high	rectangle	HPL	UNTL 247236RE S	2	24"	panel	2940	3825
24 x 72 x 42 high	rectangle	HPL	UNTL 247242RE S	2	24"	panel	3315	4310
24 x 72 x 29 high	rectangle	Veneer	UNTV 247229RE S	2	24"	panel	7075	N/A
24 x 72 x 36 high	rectangle	Veneer	UNTV 247236RE S	2	24"	panel	7675	N/A
24 x 72 x 42 high	rectangle	Veneer	UNTV 247242RE S	2	24"	panel	8815	N/A
24 x 84 x 29 high	rectangle	HPL	UNTL 248429RE S	2	24"	panel	2940	3825
24 x 84 x 36 high	rectangle	HPL	UNTL 248436RE S	2	24"	panel	3130	4065
24 x 84 x 42 high	rectangle	HPL	UNTL 248442RE S	2	24"	panel	3500	4550
24 x 84 x 29 high	rectangle	Veneer	UNTV 248429RE S	2	24"	panel	7660	N/A
24 x 84 x 36 high	rectangle	Veneer	UNTV 248436RE S	2	24"	panel	8235	N/A
24 x 84 x 42 high	rectangle	Veneer	UNTV 248442RE S	2	24"	panel	9390	N/A
24 x 96 x 29 high	rectangle	HPL	UNTL 249629RE S	2	24"	panel	3130	4065
24 x 96 x 36 high	rectangle	HPL	UNTL 249636RE S	2	24"	panel	3315	4310
24 x 96 x 42 high	rectangle	HPL	UNTL 249642RE S	2	24"	panel	3685	4790
24 x 96 x 29 high	rectangle	Veneer	UNTV 249629RE S	2	24"	panel	8235	N/A
24 x 96 x 36 high	rectangle	Veneer	UNTV 249636RE S	2	24"	panel	8815	N/A
24 x 96 x 42 high	rectangle	Veneer	UNTV 249642RE S	2	24"	panel	9975	N/A
24 x 120 x 29 high	rectangle	HPL	UNTL 2412029RE S	2	24"	panel	3500	4550
24 x 120 x 36 high	rectangle	HPL	UNTL 2412036RE S	2	24"	panel	3685	4790
24 x 120 x 42 high	rectangle	HPL	UNTL 2412042RE S	2	24"	panel	4060	5275
24 x 120 x 29 high	rectangle	Veneer	UNTV 2412029RE S	2	24"	panel	9390	N/A
24 x 120 x 36 high	rectangle	Veneer	UNTV 2412036RE S	2	24"	panel	9975	N/A
24 x 120 x 42 high	rectangle	Veneer	UNTV 2412042RE S	2	24"	panel	11,130	N/A
24 x 144 x 29 high	rectangle	HPL	UNTL 2414429RE S	3	24"	panel	6540	8505
24 x 144 x 36 high	rectangle	HPL	UNTL 2414436RE S	3	24"	panel	6825	8870
24 x 144 x 42 high	rectangle	HPL	UNTL 2414442RE S	3	24"	panel	7380	9595
24 x 144 x 29 high	rectangle	Veneer	UNTV 2414429RE S	3	24"	panel	14,210	N/A
24 x 144 x 36 high	rectangle	Veneer	UNTV 2414436RE S	3	24"	panel	15,705	N/A
24 x 144 x 42 high	rectangle	Veneer	UNTV 2414442RE S	3	24"	panel	16,815	N/A
24 x 168 x 29 high	rectangle	HPL	UNTL 2416829RE S	3	24"	panel	6915	8990
24 x 168 x 36 high	rectangle	HPL	UNTL 2416836RE S	3	24"	panel	7195	9355
24 x 168 x 42 high	rectangle	HPL	UNTL 2416842RE S	3	24"	panel	7755	10,080
24 x 168 x 29 high	rectangle	Veneer	UNTV 2416829RE S	3	24"	panel	15,360	N/A
24 x 168 x 36 high	rectangle	Veneer	UNTV 2416836RE S	3	24"	panel	16,230	N/A
24 x 168 x 42 high	rectangle	Veneer	UNTV 2416842RE S	3	24"	panel	17,970	N/A

TABLE OPTIONS

Premium Laminate	UCL	Contact Factory
Accent laminate table bases and underside of table top – standard laminate	UCA	5% upcharge on list price on a basic table
Accent laminate table bases and underside of table top – premium laminate	UCA	Contact Factory

POWER & AV OPTIONS : [page 21- 38]

Non-powered round ABS plastic Grommet (black or silver) List location code on page 18	G (B/S)	\$20 per grommet
Non-powered rectangle metal Grommet (black or silver) List location code on page 18	GV (B/S)	\$120 per grommet

WIRE MANAGEMENT: [page 40 - 42]

Customer specified hole cut into top	CNC	\$250 set up fee per template
36" long Horizontal 4 track Extruded Raceway	WH	\$80 per piece
Horizontal conference raceway	WT	\$475 per table
Vertical wire management - 4 track Extruded Raceway	WM	\$100 list per base



How to Order:
Email orders to: sales@hi5furniture.com

1. Choose your base model
2. Add edge code to base model
3. Choose finishes
4. Select options to add to table
5. Select finishes of options



Table Size	Top Shape	Base Material	Base Model Code:	Base QTY	Base Size	Base Style	L8 edge 2" thick top	Price with Color Core
30 x 60 x 29 high	rectangle	HPL	UNTL 306029RE S	2	30"	panel	3030	3940
30 x 60 x 36 high	rectangle	HPL	UNTL 306036RE S	2	30"	panel	3405	4425
30 x 60 x 42 high	rectangle	HPL	UNTL 306042RE S	2	30"	panel	3775	4910
30 x 60 x 29 high	rectangle	Veneer	UNTV 306029RE S	2	30"	panel	7950	N/A
30 x 60 x 36 high	rectangle	Veneer	UNTV 306036RE S	2	30"	panel	9110	N/A
30 x 60 x 42 high	rectangle	Veneer	UNTV 306042RE S	2	30"	panel	10,260	N/A
30 x 72 x 29 high	rectangle	HPL	UNTL 307229RE S	2	30"	panel	3405	4425
30 x 72 x 36 high	rectangle	HPL	UNTL 307236RE S	2	30"	panel	3775	4910
30 x 72 x 42 high	rectangle	HPL	UNTL 307242RE S	2	30"	panel	4150	5390
30 x 72 x 29 high	rectangle	Veneer	UNTV 307229RE S	2	30"	panel	9110	N/A
30 x 72 x 36 high	rectangle	Veneer	UNTV 307236RE S	2	30"	panel	10,260	N/A
30 x 72 x 42 high	rectangle	Veneer	UNTV 307242RE S	2	30"	panel	11,420	N/A
30 x 84 x 29 high	rectangle	HPL	UNTL 308429RE S	2	30"	panel	3500	4550
30 x 84 x 36 high	rectangle	HPL	UNTL 308436RE S	2	30"	panel	3870	5035
30 x 84 x 42 high	rectangle	HPL	UNTL 308442RE S	2	30"	panel	4245	5515
30 x 84 x 29 high	rectangle	Veneer	UNTV 308429RE S	2	30"	panel	9390	N/A
30 x 84 x 36 high	rectangle	Veneer	UNTV 308436RE S	2	30"	panel	10,550	N/A
30 x 84 x 42 high	rectangle	Veneer	UNTV 308442RE S	2	30"	panel	11,710	N/A
30 x 96 x 29 high	rectangle	HPL	UNTL 309629RE S	2	30"	panel	3685	4790
30 x 96 x 36 high	rectangle	HPL	UNTL 309636RE S	2	30"	panel	4060	5275
30 x 96 x 42 high	rectangle	HPL	UNTL 309642RE S	2	30"	panel	4430	5760
30 x 96 x 29 high	rectangle	Veneer	UNTV 309629RE S	2	30"	panel	9975	N/A
30 x 96 x 36 high	rectangle	Veneer	UNTV 309636RE S	2	30"	panel	11,130	N/A
30 x 96 x 42 high	rectangle	Veneer	UNTV 309642RE S	2	30"	panel	12,290	N/A
30 x 120 x 29 high	rectangle	HPL	UNTL 3012029RE S	2	30"	panel	4060	5275
30 x 120 x 36 high	rectangle	HPL	UNTL 3012036RE S	2	30"	panel	4430	5760
30 x 120 x 42 high	rectangle	HPL	UNTL 3012042RE S	2	30"	panel	4800	6240
30 x 120 x 29 high	rectangle	Veneer	UNTV 3012029RE S	2	30"	panel	11,130	N/A
30 x 120 x 36 high	rectangle	Veneer	UNTV 3012036RE S	2	30"	panel	12,290	N/A
30 x 120 x 42 high	rectangle	Veneer	UNTV 3012042RE S	2	30"	panel	13,450	N/A
30 x 144 x 29 high	rectangle	HPL	UNTL 3014429RE S	3	30"	panel	7195	9355
30 x 144 x 36 high	rectangle	HPL	UNTL 3014436RE S	3	30"	panel	7755	10,080
30 x 144 x 42 high	rectangle	HPL	UNTL 3014442RE S	3	30"	panel	8310	10,805
30 x 144 x 29 high	rectangle	Veneer	UNTV 3014429RE S	3	30"	panel	16,230	N/A
30 x 144 x 36 high	rectangle	Veneer	UNTV 3014436RE S	3	30"	panel	17,970	N/A
30 x 144 x 42 high	rectangle	Veneer	UNTV 3014442RE S	3	30"	panel	19,705	N/A
30 x 168 x 29 high	rectangle	HPL	UNTL 3016829RE S	3	30"	panel	7570	9340
30 x 168 x 36 high	rectangle	HPL	UNTL 3016836RE S	3	30"	panel	8125	10,565
30 x 168 x 42 high	rectangle	HPL	UNTL 3016842RE S	3	30"	panel	8685	11,290
30 x 168 x 29 high	rectangle	Veneer	UNTV 3016829RE S	3	30"	panel	17,390	N/A
30 x 168 x 36 high	rectangle	Veneer	UNTV 3016836RE S	3	30"	panel	19,130	N/A
30 x 168 x 42 high	rectangle	Veneer	UNTV 3016842RE S	3	30"	panel	20,865	N/A

TABLE OPTIONS

Premium Laminate	UCL	Contact Factory
Accent laminate table bases and underside of table top - standard laminate	UCA	5% upcharge on list price on a basic table
Accent laminate table bases and underside of table top - premium laminate	UCA	Contact Factory

POWER & AV OPTIONS: [page 21- 38]

Non-powered round ABS plastic Grommet (black or silver) List location code on page 18	G (B/S)	\$20 per grommet
Non-powered rectangle metal Grommet (black or silver) List location code on page 18	GV (B/S)	\$120 per grommet

WIRE MANAGEMENT: [page 40 - 42]

Customer specified hole cut into top	CNC	\$250 set up fee per template
36" long Horizontal 4 track Extruded Raceway	WH	\$80 per piece
Horizontal conference raceway	WT	\$475 per table
Vertical wire management - 4 track Extruded Raceway	WM	\$100 list per base



How to Order:
 Email orders to: sales@hi5furniture.com

1. Choose your base model
2. Add edge code to base model
3. Choose finishes
4. Select options to add to table
5. Select finishes of options



Table Size	Top Shape	Base Material	Model Code:	Base QTY	Base Size	Base Style	L8 edge 2" thick top	Price with Color Core
36 x 60 x 29 high	rectangle	HPL	UNTL 366029RE S	2	36"	panel	4550	5915
36 x 60 x 36 high	rectangle	HPL	UNTL 366036RE S	2	36"	panel	4735	6155
36 x 60 x 42 high	rectangle	HPL	UNTL 366042RE S	2	36"	panel	5295	6880
36 x 60 x 29 high	rectangle	Veneer	UNTV 366029RE S	2	36"	panel	10,040	N/A
36 x 60 x 36 high	rectangle	Veneer	UNTV 366036RE S	2	36"	panel	10,620	N/A
36 x 60 x 42 high	rectangle	Veneer	UNTV 366042RE S	2	36"	panel	12,355	N/A
36 x 72 x 29 high	rectangle	HPL	UNTL 367229RE S	2	36"	panel	4830	6280
36 x 72 x 36 high	rectangle	HPL	UNTL 367236RE S	2	36"	panel	5020	6525
36 x 72 x 42 high	rectangle	HPL	UNTL 367242RE S	2	36"	panel	5575	7250
36 x 72 x 29 high	rectangle	Veneer	UNTV 367229RE S	2	36"	panel	10,910	N/A
36 x 72 x 36 high	rectangle	Veneer	UNTV 367236RE S	2	36"	panel	11,490	N/A
36 x 72 x 42 high	rectangle	Veneer	UNTV 367242RE S	2	36"	panel	13,225	N/A
36 x 84 x 29 high	rectangle	HPL	UNTL 368429RE S	2	36"	panel	5110	6640
36 x 84 x 36 high	rectangle	HPL	UNTL 368436RE S	2	36"	panel	5295	6880
36 x 84 x 42 high	rectangle	HPL	UNTL 368442RE S	2	36"	panel	5850	7605
36 x 84 x 29 high	rectangle	Veneer	UNTV 368429RE S	2	36"	panel	11,780	N/A
36 x 84 x 36 high	rectangle	Veneer	UNTV 368436RE S	2	36"	panel	12,355	N/A
36 x 84 x 42 high	rectangle	Veneer	UNTV 368442RE S	2	36"	panel	14,095	N/A
36 x 96 x 29 high	rectangle	HPL	UNTL 369629RE S	2	36"	panel	5935	7715
36 x 96 x 36 high	rectangle	HPL	UNTL 369636RE S	2	36"	panel	5575	7250
36 x 96 x 42 high	rectangle	HPL	UNTL 369642RE S	2	36"	panel	6135	7975
36 x 96 x 29 high	rectangle	Veneer	UNTV 369629RE S	2	36"	panel	12,650	N/A
36 x 96 x 36 high	rectangle	Veneer	UNTV 369636RE S	2	36"	panel	13,225	N/A
36 x 96 x 42 high	rectangle	Veneer	UNTV 369642RE S	2	36"	panel	13,965	N/A
36 x 120 x 29 high	rectangle	HPL	UNTL 3612029RE S	2	36"	panel	5950	7730
36 x 120 x 36 high	rectangle	HPL	UNTL 3612036RE S	2	36"	panel	6135	7975
36 x 120 x 42 high	rectangle	HPL	UNTL 3612042RE S	2	36"	panel	6690	8700
36 x 120 x 29 high	rectangle	Veneer	UNTV 3612029RE S	2	36"	panel	14,385	N/A
36 x 120 x 36 high	rectangle	Veneer	UNTV 3612036RE S	2	36"	panel	14,965	N/A
36 x 120 x 42 high	rectangle	Veneer	UNTV 3612042RE S	2	36"	panel	16,700	N/A
36 x 144 x 29 high	rectangle	HPL	UNTL 3614429RE S	3	36"	panel	8800	11,435
36 x 144 x 36 high	rectangle	HPL	UNTL 3614436RE S	3	36"	panel	9075	11,795
36 x 144 x 42 high	rectangle	HPL	UNTL 3614442RE S	3	36"	panel	9915	12,890
36 x 144 x 29 high	rectangle	Veneer	UNTV 3614429RE S	3	36"	panel	20,590	N/A
36 x 144 x 36 high	rectangle	Veneer	UNTV 3614436RE S	3	36"	panel	21,450	N/A
36 x 144 x 42 high	rectangle	Veneer	UNTV 3614442RE S	3	36"	panel	24,060	N/A
36 x 168 x 29 high	rectangle	HPL	UNTL 3616829RE S	3	36"	panel	9355	12,165
36 x 168 x 36 high	rectangle	HPL	UNTL 3616836RE S	3	36"	panel	9630	12,520
36 x 168 x 42 high	rectangle	HPL	UNTL 3616842RE S	3	36"	panel	10,470	13,615
36 x 168 x 29 high	rectangle	Veneer	UNTV 3616829RE S	3	36"	panel	22,320	N/A
36 x 168 x 36 high	rectangle	Veneer	UNTV 3616836RE S	3	36"	panel	23,190	N/A
36 x 168 x 42 high	rectangle	Veneer	UNTV 3616842RE S	3	36"	panel	25,795	N/A

TABLE OPTIONS

Premium Laminate	UCL	Contact Factory
Accent laminate table bases and underside of table top – standard laminate	UCA	5% upcharge on list price on a basic table
Accent laminate table bases and underside of table top – premium laminate	UCA	Contact Factory

POWER & AV OPTIONS : [page 21- 38]

Non-powered round ABS plastic Grommet (black or silver) List location code on page 18	G (B/S)	\$20 per grommet
Non-powered rectangle metal Grommet (black or silver) List location code on page 18	GV (B/S)	\$120 per grommet

WIRE MANAGEMENT: [page 40 - 42]

Customer specified hole cut into top	CNC	\$250 set up fee per template
36" long Horizontal 4 track Extruded Raceway	WH	\$80 per piece
Horizontal conference raceway	WT	\$475 per table
Vertical wire management - 4 track Extruded Raceway	WM	\$100 list per base



How to Order:
Email orders to: sales@hi5furniture.com
1. Choose your base model
2. Add edge code to base model
3. Choose finishes
4. Select options to add to table
5. Select finishes of options



Table Size	Top Shape	Base Material	Base Model Code:	Base QTY	Base Size	Base Style	L8 edge 2" thick top	Price with Color Core
42 x 60 x 29 high	rectangle	HPL	UNTL 426029RE S	2	42"	panel	5140	6680
42 x 60 x 36 high	rectangle	HPL	UNTL 426036RE S	2	42"	panel	5510	7165
42 x 60 x 42 high	rectangle	HPL	UNTL 426042RE S	2	42"	panel	6255	8130
42 x 60 x 29 high	rectangle	Veneer	UNTV 426029RE S	2	42"	panel	13000	N/A
42 x 60 x 36 high	rectangle	Veneer	UNTV 426036RE S	2	42"	panel	14155	N/A
42 x 60 x 42 high	rectangle	Veneer	UNTV 426042RE S	2	42"	panel	16470	N/A
42 x 72 x 29 high	rectangle	HPL	UNTL 427229RE S	2	42"	panel	5510	7165
42 x 72 x 36 high	rectangle	HPL	UNTL 427236RE S	2	42"	panel	5880	7645
42 x 72 x 42 high	rectangle	HPL	UNTL 427242RE S	2	42"	panel	6625	8615
42 x 72 x 29 high	rectangle	Veneer	UNTV 427229RE S	2	42"	panel	14155	N/A
42 x 72 x 36 high	rectangle	Veneer	UNTV 427236RE S	2	42"	panel	15315	N/A
42 x 72 x 42 high	rectangle	Veneer	UNTV 427242RE S	2	42"	panel	17630	N/A
42 x 84 x 29 high	rectangle	HPL	UNTL 428429RE S	2	42"	panel	5880	7645
42 x 84 x 36 high	rectangle	HPL	UNTL 428436RE S	2	42"	panel	6255	8130
42 x 84 x 42 high	rectangle	HPL	UNTL 428442RE S	2	42"	panel	7370	9095
42 x 84 x 29 high	rectangle	Veneer	UNTV 428429RE S	2	42"	panel	15,315	N/A
42 x 84 x 36 high	rectangle	Veneer	UNTV 428436RE S	2	42"	panel	16470	N/A
42 x 84 x 42 high	rectangle	Veneer	UNTV 428442RE S	2	42"	panel	18790	N/A
42 x 96 x 29 high	rectangle	HPL	UNTL 429629RE S	2	42"	panel	6255	8130
42 x 96 x 36 high	rectangle	HPL	UNTL 429636RE S	2	42"	panel	6625	8615
42 x 96 x 42 high	rectangle	HPL	UNTL 429642RE S	2	42"	panel	7770	9580
42 x 96 x 29 high	rectangle	Veneer	UNTV 429629RE S	2	42"	panel	16470	N/A
42 x 96 x 36 high	rectangle	Veneer	UNTV 429636RE S	2	42"	panel	17630	N/A
42 x 96 x 42 high	rectangle	Veneer	UNTV 429642RE S	2	42"	panel	19945	N/A
42 x 120 x 29 high	rectangle	HPL	UNTL 4212029RE S	2	42"	panel	7000	9095
42 x 120 x 36 high	rectangle	HPL	UNTL 4212036RE S	2	42"	panel	7370	9580
42 x 120 x 42 high	rectangle	HPL	UNTL 4212042RE S	2	42"	panel	8115	10,550
42 x 120 x 29 high	rectangle	Veneer	UNTV 4212029RE S	2	42"	panel	18790	N/A
42 x 120 x 36 high	rectangle	Veneer	UNTV 4212036RE S	2	42"	panel	19945	N/A
42 x 120 x 42 high	rectangle	Veneer	UNTV 4212042RE S	2	42"	panel	22260	N/A
42 x 144 x 29 high	rectangle	HPL	UNTL 4214429RE S	3	42"	panel	11470	14,910
42 x 144 x 36 high	rectangle	HPL	UNTL 4214436RE S	3	42"	panel	12025	15,635
42 x 144 x 42 high	rectangle	HPL	UNTL 4214442RE S	3	42"	panel	13140	17,085
42 x 144 x 29 high	rectangle	Veneer	UNTV 4214429RE S	3	42"	panel	26790	N/A
42 x 144 x 36 high	rectangle	Veneer	UNTV 4214436RE S	3	42"	panel	28530	N/A
42 x 144 x 42 high	rectangle	Veneer	UNTV 4214442RE S	3	42"	panel	32005	N/A
42 x 168 x 29 high	rectangle	HPL	UNTL 4216829RE S	3	42"	panel	12210	15,875
42 x 168 x 36 high	rectangle	HPL	UNTL 4216836RE S	3	42"	panel	12770	16,600
42 x 168 x 42 high	rectangle	HPL	UNTL 4216842RE S	3	42"	panel	13885	18,050
42 x 168 x 29 high	rectangle	Veneer	UNTV 4216829RE S	3	42"	panel	29110	N/A
42 x 168 x 36 high	rectangle	Veneer	UNTV 4216836RE S	3	42"	panel	30850	N/A
42 x 168 x 42 high	rectangle	Veneer	UNTV 4216842RE S	3	42"	panel	34320	N/A

TABLE OPTIONS

Premium Laminate	UCL	Contact Factory
Accent laminate table bases and underside of table top – standard laminate	UCA	5% upcharge on list price on a basic table
Accent laminate table bases and underside of table top – premium laminate	UCA	Contact Factory

POWER & AV OPTIONS : [page 21- 38]

Non-powered round ABS plastic Grommet (black or silver) List location code on page 18	G (B/S)	\$20 per grommet
Non-powered rectangle metal Grommet (black or silver) List location code on page 18	GV (B/S)	\$120 per grommet

WIRE MANAGEMENT: [page 40 - 42]

Customer specified hole cut into top	CNC	\$250 set up fee per template
36" long Horizontal 4 track Extruded Raceway	WH	\$80 per piece
Horizontal conference raceway	WT	\$475 per table
Vertical wire management - 4 track Extruded Raceway	WM	\$100 list per base



How to Order:
 Email orders to: sales@hi5furniture.com
 1. Choose your base model
 2. Add edge code to base model
 3. Choose finishes
 4. Select options to add to table
 5. Select finishes of options



Table Size	Top Shape	Base Material	Base Model Code:	Base QTY	Base Size	Base Style	L8 edge 2" thick top	Price with Color Core
48 x 60 x 29 high	rectangle	HPL	UNTL 486029RE S	2	48"	panel	5140	6680
48 x 60 x 48 high	rectangle	HPL	UNTL 486036RE S	2	48"	panel	5510	7165
48 x 60 x 36 high	rectangle	HPL	UNTL 486042RE S	2	48"	panel	6255	8130
48 x 60 x 29 high	rectangle	Veneer	UNTV 486029RE S	2	48"	panel	13,000	N/A
48 x 60 x 36 high	rectangle	Veneer	UNTV 486036RE S	2	48"	panel	14,155	N/A
48 x 60 x 42 high	rectangle	Veneer	UNTV 486042RE S	2	48"	panel	16,470	N/A
48 x 72 x 29 high	rectangle	HPL	UNTL 487229RE S	2	48"	panel	5510	7165
48 x 72 x 36 high	rectangle	HPL	UNTL 487236RE S	2	48"	panel	5880	7645
48 x 72 x 42 high	rectangle	HPL	UNTL 487242RE S	2	48"	panel	6625	9095
48 x 72 x 29 high	rectangle	Veneer	UNTV 487229RE S	2	48"	panel	14,155	N/A
48 x 72 x 36 high	rectangle	Veneer	UNTV 487236RE S	2	48"	panel	15,315	N/A
48 x 72 x 42 high	rectangle	Veneer	UNTV 487242RE S	2	48"	panel	1,7630	N/A
48 x 84 x 29 high	rectangle	HPL	UNTL 488429RE S	2	48"	panel	5880	8130
48 x 84 x 36 high	rectangle	HPL	UNTL 488436RE S	2	48"	panel	6255	8615
48 x 84 x 42 high	rectangle	HPL	UNTL 488442RE S	2	48"	panel	7370	9580
48 x 84 x 29 high	rectangle	Veneer	UNTV 488429RE S	2	48"	panel	15,315	N/A
48 x 84 x 36 high	rectangle	Veneer	UNTV 488436RE S	2	48"	panel	16,470	N/A
48 x 84 x 42 high	rectangle	Veneer	UNTV 488442RE S	2	48"	panel	18,790	N/A
48 x 96 x 29 high	rectangle	HPL	UNTL 489629RE S	2	48"	panel	6255	8130
48 x 96 x 36 high	rectangle	HPL	UNTL 489636RE S	2	48"	panel	6625	8615
48 x 96 x 42 high	rectangle	HPL	UNTL 489642RE S	2	48"	panel	7770	9580
48 x 96 x 29 high	rectangle	Veneer	UNTV 489629RE S	2	48"	panel	16,470	N/A
48 x 96 x 36 high	rectangle	Veneer	UNTV 489636RE S	2	48"	panel	17,630	N/A
48 x 96 x 42 high	rectangle	Veneer	UNTV 489642RE S	2	48"	panel	19,945	N/A
48 x 120 x 29 high	rectangle	HPL	UNTL 4812029RE S	2	48"	panel	7000	9095
48 x 120 x 36 high	rectangle	HPL	UNTL 4812036RE S	2	48"	panel	7370	9580
48 x 120 x 42 high	rectangle	HPL	UNTL 4812042RE S	2	48"	panel	8115	10,550
48 x 120 x 29 high	rectangle	Veneer	UNTV 4812029RE S	2	48"	panel	18,790	N/A
48 x 120 x 36 high	rectangle	Veneer	UNTV 4812036RE S	2	48"	panel	19,945	N/A
48 x 120 x 42 high	rectangle	Veneer	UNTV 4812042RE S	2	48"	panel	22,260	N/A
48 x 144 x 29 high	rectangle	HPL	UNTL 4814429RE S	3	48"	panel	11470	14,910
48 x 144 x 36 high	rectangle	HPL	UNTL 4814436RE S	3	48"	panel	12025	15,635
48 x 144 x 42 high	rectangle	HPL	UNTL 4814442RE S	3	48"	panel	13140	17,085
48 x 144 x 29 high	rectangle	Veneer	UNTV 4814429RE S	3	48"	panel	26,790	N/A
48 x 144 x 36 high	rectangle	Veneer	UNTV 4814436RE S	3	48"	panel	28,530	N/A
48 x 144 x 42 high	rectangle	Veneer	UNTV 4814442RE S	3	48"	panel	32,005	N/A
48 x 168 x 29 high	rectangle	HPL	UNTL 4816829RE S	3	48"	panel	12,210	15,875
48 x 168 x 36 high	rectangle	HPL	UNTL 4816836RE S	3	48"	panel	12,770	16,600
48 x 168 x 42 high	rectangle	HPL	UNTL 4816842RE S	3	48"	panel	13,885	18,050
48 x 168 x 29 high	rectangle	Veneer	UNTV 4816829RE S	3	48"	panel	29,110	N/A
48 x 168 x 36 high	rectangle	Veneer	UNTV 4816836RE S	3	48"	panel	30,850	N/A
48 x 168 x 42 high	rectangle	Veneer	UNTV 4816842RE S	3	48"	panel	34,320	N/A

TABLE OPTIONS

Premium Laminate	UCL	Contact Factory
Accent laminate table bases and underside of table top – standard laminate	UCA	5% upcharge on list price on a basic table
Accent laminate table bases and underside of table top – premium laminate	UCA	Contact Factory

POWER & AV OPTIONS : [page 21- 38]

Non-powered round ABS plastic Grommet (black or silver) List location code on page 18	G (B/S)	\$20 per grommet
Non-powered rectangle metal Grommet (black or silver) List location code on page 18	GV (B/S)	\$120 per grommet

WIRE MANAGEMENT: [page 40 - 42]

Customer specified hole cut into top	CNC	\$250 set up fee per template
36" long Horizontal 4 track Extruded Raceway	WH	\$80 per piece
Horizontal conference raceway	WT	\$475 per table
Vertical wire management - 4 track Extruded Raceway	WM	\$100 list per base



- How to Order:**
Email orders to: sales@hi5furniture.com
1. Choose your base model
 2. Add edge code to base model
 3. Choose finishes
 4. Select options to add to table
 5. Select finishes of options



Table Size	Top Shape	Base Material	Base Model Code:	Base QTY	Base Size	Base Style	L8 edge 2" thick top	Price with Color Core
60 x 60 x 29 high	rectangle	HPL	UNTL 606029RE S	2	60"	panel	6160	8005
60 x 60 x 36 high	rectangle	HPL	UNTL 606036RE S	2	60"	panel	6530	8490
60 x 60 x 42 high	rectangle	HPL	UNTL 606042RE S	2	60"	panel	7090	9215
60 x 60 x 29 high	rectangle	Veneer	UNTV 606029RE S	2	60"	panel	16,180	N/A
60 x 60 x 36 high	rectangle	Veneer	UNTV 606036RE S	2	60"	panel	17,335	N/A
60 x 60 x 42 high	rectangle	Veneer	UNTV 606042RE S	2	60"	panel	19,075	N/A
60 x 72 x 29 high	rectangle	HPL	UNTL 607229RE S	2	60"	panel	6625	8615
60 x 72 x 36 high	rectangle	HPL	UNTL 607236RE S	2	60"	panel	7000	9095
60 x 72 x 42 high	rectangle	HPL	UNTL 607242RE S	2	60"	panel	7555	9825
60 x 72 x 29 high	rectangle	Veneer	UNTV 607229RE S	2	60"	panel	17,630	N/A
60 x 72 x 36 high	rectangle	Veneer	UNTV 607236RE S	2	60"	panel	18,790	N/A
60 x 72 x 42 high	rectangle	Veneer	UNTV 607242RE S	2	60"	panel	20,520	N/A
60 x 84 x 29 high	rectangle	HPL	UNTL 608429RE S	2	60"	panel	7090	9215
60 x 84 x 36 high	rectangle	HPL	UNTL 608436RE S	2	60"	panel	7460	9700
60 x 84 x 42 high	rectangle	HPL	UNTL 608442RE S	2	60"	panel	8020	10,425
60 x 84 x 29 high	rectangle	Veneer	UNTV 608429RE S	2	60"	panel	19,075	N/A
60 x 84 x 36 high	rectangle	Veneer	UNTV 608436RE S	2	60"	panel	20,235	N/A
60 x 84 x 42 high	rectangle	Veneer	UNTV 608442RE S	2	60"	panel	21,970	N/A
60 x 96 x 29 high	rectangle	HPL	UNTL 609629RE S	2	60"	panel	7555	9825
60 x 96 x 36 high	rectangle	HPL	UNTL 609636RE S	2	60"	panel	7930	10,305
60 x 96 x 42 high	rectangle	HPL	UNTL 609642RE S	2	60"	panel	8485	11,030
60 x 96 x 29 high	rectangle	Veneer	UNTV 609629RE S	2	60"	panel	20,520	N/A
60 x 96 x 36 high	rectangle	Veneer	UNTV 609636RE S	2	60"	panel	21,680	N/A
60 x 96 x 42 high	rectangle	Veneer	UNTV 609642RE S	2	60"	panel	23,420	N/A
60 x 120 x 29 high	rectangle	HPL	UNTL 6012029RE S	2	60"	panel	8485	11,030
60 x 120 x 36 high	rectangle	HPL	UNTL 6012036RE S	2	60"	panel	8860	11,515
60 x 120 x 42 high	rectangle	HPL	UNTL 6012042RE S	2	60"	panel	9415	12,240
60 x 120 x 29 high	rectangle	Veneer	UNTV 6012029RE S	2	60"	panel	23,420	N/A
60 x 120 x 36 high	rectangle	Veneer	UNTV 6012036RE S	2	60"	panel	24,580	N/A
60 x 120 x 42 high	rectangle	Veneer	UNTV 6012042RE S	2	60"	panel	26,310	N/A
60 x 144 x 29 high	rectangle	HPL	UNTL 6014429RE S	3	60"	panel	13420	17,445
60 x 144 x 36 high	rectangle	HPL	UNTL 6014436RE S	3	60"	panel	13975	18,170
60 x 144 x 42 high	rectangle	HPL	UNTL 6014442RE S	3	60"	panel	14815	19,260
60 x 144 x 29 high	rectangle	Veneer	UNTV 6014429RE S	3	60"	panel	32,870	N/A
60 x 144 x 36 high	rectangle	Veneer	UNTV 6014436RE S	3	60"	panel	34,610	N/A
60 x 144 x 42 high	rectangle	Veneer	UNTV 6014442RE S	3	60"	panel	37,215	N/A
60 x 168 x 29 high	rectangle	HPL	UNTL 6016829RE S	3	60"	panel	14350	18,650
60 x 168 x 36 high	rectangle	HPL	UNTL 6016836RE S	3	60"	panel	14905	19,380
60 x 168 x 42 high	rectangle	HPL	UNTL 6016842RE S	3	60"	panel	15745	20,470
60 x 168 x 29 high	rectangle	Veneer	UNTV 6016829RE S	3	60"	panel	35,770	N/A
60 x 168 x 36 high	rectangle	Veneer	UNTV 6016836RE S	3	60"	panel	37,500	N/A
60 x 168 x 42 high	rectangle	Veneer	UNTV 6016842RE S	3	60"	panel	40,110	N/A

TABLE OPTIONS

Premium Laminate	UCL	Contact Factory
Accent laminate table bases and underside of table top – standard laminate	UCA	5% upcharge on list price on a basic table
Accent laminate table bases and underside of table top – premium laminate	UCA	Contact Factory

POWER & AV OPTIONS : [page 21- 38]

Non-powered round ABS plastic Grommet (black or silver) List location code on page 18	G (B/S)	\$20 per grommet
Non-powered rectangle metal Grommet (black or silver) List location code on page 18	GV (B/S)	\$120 per grommet

WIRE MANAGEMENT: [page 40 - 42]

Customer specified hole cut into top	CNC	\$250 set up fee per template
36" long Horizontal 4 track Extruded Raceway	WH	\$80 per piece
Horizontal conference raceway	WT	\$475 per table
Vertical wire management - 4 track Extruded Raceway	WM	\$100 list per base

Ordering Information:

How to Order:

Email orders to: sales@hi5furniture.com

1. Choose your base model
2. Add edge code to base model
3. Choose finishes
4. Select options to add to table
5. Select finishes of options

When placing your order with Hi5 Furniture please be sure to include the following information:

- The Hi5 Quote Number, if applicable
- Net prices
- Any special discounts
- Complete and valid model code numbers
- All relevant laminate, edge, grommet and base colors – codes and description
- Sold to and Ship to addresses
- A purchase order number
- A contact name and phone number
- A requested ship date
- Clearly stated special instructions, if any.

Purchase Orders

Orders may be placed by:

Fax 816-817-4910

E-mail: SALES@hi5furniture.com

All orders must be confirmed in writing with a signature of authorized buyer before beginning production.

Eligibility

Hi5 Furniture, Inc.'s products are sold nationally through authorized furniture dealers. Possession of this price list does constitute authorization to sell and/or purchase products listed herein.

New Dealer Accounts

All orders are subject to Hi5 Furniture's credit department. First time orders under \$2,000 net must be paid in advance. Orders over \$2,000 net require a 50% deposit. New account orders in MO and FL must be accompanied by a State Resale/Exemption Certificate or sales tax will be charged. Hi5 Furniture's is not responsible for collecting sales tax in any other state. If you are not tax exempt, sales tax must be self-assessed. Credit approval process could take up to 10 days. Orders will not begin production until credit approval is complete unless prepaid. Hi5 Furniture may review, change, or cancel credit terms and/or request advance payment at any time.

Terms

Orders over \$20,000 net require a 50% deposit with standard approved terms of Net 30 from the date of invoice. All past due accounts will accrue a 2% per month service charge. Hi5 Furniture reserves the right to withhold production or shipment of completed products due to any past due invoices or failure to satisfy credit requirements.

Credit Card

Hi5 accepts MasterCard and Visa. There is a 5% convenience fee charged on all charges.

Prices

All prices listed herein are effective on the date printed on the cover and supersede all previous contract price lists and/or brochures. Prices do not include storage, installation or freight charges. See freight policy for details. Products specifications and pricing can change at any time without prior notice.

Custom Products

Hi5 Furniture has made every effort to offer a broad range of standard products. We welcome the opportunity to provide a custom quote based on your input. Please Contact Factory for details. Hi5 Furniture cannot be responsible for space layout/design of products. We will provide recommendations based on your input. Custom products cannot be cancelled or returned. Custom products require a 50% deposit before production begins.

Storage

Items held at Hi5 Furniture's more than thirty days after completed scheduled ship date are invoiced and storage charges will begin accruing at that time. Storage fees are based on the net total and are charged as follows: One month 2%, Two months 4%, Three months 8%, Four months 12%, and so on.

Order Acknowledgements

All orders are acknowledged upon entering as Hi5 Furniture interprets them. All acknowledgements are sent via fax or e-mail attention the contact name on the purchase order received. It is the customer's responsibility to note any discrepancies on the acknowledgement and notify Hi5 Furniture within 48 hours. If Hi5 Furniture does not receive a signed approval sheet or notification of any changes within 48 hours, we will assume that the order is correct and are not responsible for changes or errors. Hi5 Furniture lists an estimated ship date on every acknowledgement. Any order that is time sensitive or requires any special instructions, please note instructions and/or requirements on purchase order and we will make every attempt to accommodate your request. Hi5 Furniture is not responsible for any labor charges or installation fees if the shipping date does not meet your requirements.

Order Changes

All requests to make changes to an existing order must be submitted in writing. We will make every attempt to accommodate your requested changes. Any change to an order may be subject to a revised scheduled ship date and/or additional charges for materials and labor.

Hi5 Furniture Terms and Conditions – *continued*

August 1, 2014 Price List (Rev. A)

Cancellations/Returns

All requests for cancellations or returns must be submitted in writing for approval by Hi5 Furniture. Please include the following information with your request; Copy of your original sales order and reason for requested cancellation or return.

Orders Approved for Cancellation

Hi5 Furniture will fax an acknowledgement stating that the order has been cancelled. All cancelled orders and/or returns are subject to a 50% restocking fee.

Orders Approved for Return

An RMA (Return Materials Authorization) will be sent with details for return. All products must be packed as they were originally received and returned freight prepaid to our factory unless otherwise noted on RMA. Customer is responsible for any additional damages in transit due to improper packaging. No collect shipments will be accepted for any reason. Please clearly mark all packages with RMA# to expedite RMA process.

Freight

All products are shipped in compliance with the National Motor Freight Classification Code. All products ship unassembled unless otherwise specified by Hi5 Furniture. Freight is prepaid on a dock to dock basis for all orders exceeding \$1,500 net when shipped within the 48 domestic states excluding Alaska and Hawaii or export. All orders under \$1,500 net are a flat shipping fee of \$100.00 net and will be added to the invoice. Hi5 Furniture shall not be held liable for delays caused by strikes, catastrophes, wars, riots or any other cause beyond our control.

Additional Freight Charges

All products are shipped FOB origin based on a dock to dock delivery only. Additional expenses will be debited from customer account and billed on as "shipping/handling." Examples of additional expenses are: Inside delivery, Residential delivery and Lift gate requirements all have variable charges.

Failure to inspect product at time of receipt, note damages on delivery receipt and/or notify Hi5 Furniture of damages within 10 days of the original date of receipt constitutes acceptance of products and a waiver of all claims. Neither Hi5 Furniture nor the carrier will be responsible for concealed damage claims if shipments are left unopened. **CONCEALED DAMAGE MUST BE REPORTED WITHIN 7 DAYS FROM DELIVERY TO BE VALID.** Any concealed damage reported after 7 days will not be accepted by Hi5 Furniture and is the responsibility of the customer.

Damaged Freight

All products are loaded on carrier trucks free from defects and/or damage. Responsibility of safe delivery and transport of products is assumed by the carrier upon loading. It is the customer's responsibility that all cartons, crates and packages be opened and inspected at time of delivery for damages or shortages regardless of condition. Any damages found during inspection must be clearly noted on the delivery receipt. The carriers should be notified and all packages left in original condition as received for inspection from carrier. Hi5 Furniture factory should be notified immediately. All freight claims are to be processed with the carrier, not Hi5 Furniture.

LIMITED LIFETIME WARRANTY

The following Hi5 Furniture warranty applies to products manufactured after August 1, 2014.

This warranty is given to the end user and is valid for as long as the product is owned by that user. All warranties are considered registered. If the end user is not provided at the time of the order the warranty does not apply. The warranty, which runs from the date of shipment, covers defects in materials and craftsmanship found during normal usage of the product during the warranty period. If a product is defective, and if written notice of the defect is given to Hi5 Furniture within the Applicable Warranty Period, Hi5 Furniture at its option will either repair or replace the defective product with a comparable component or product. Defective product shall be returned at the discretion of Hi5 Furniture and all returns must be authorized in writing in advance including a Return Materials Authorization Number. Hi5 Furniture, Inc. assumes no responsibility for labor or delivery charges. Freight charges for defective products and parts will be covered by Hi5 Furniture within the 48 continental United States with the method of shipping at Hi5 Furniture's discretion. The limitations of the Limited Lifetime Warranty include:

Electrical Products: Five (5) years

Wood veneer, wood edges, base glides, casters, adjustable height mechanisms, folding mechanisms, nesting or flipping mechanisms, Any options including table ganger, wire management parts, modesty panels, hardware, CPU holders, divider panels, or any moving part have a (1) year

Non-standard products: One (1) year (1) year

Third party specified and supplied products: Suppliers Warranty

All items should be inspected at two month intervals for missing glides, loose screws, broken or cracked welds, loose or unseated columns, etc. All specifications are subject to change without notice.

This warranty does not apply to damage caused by a carrier, alterations to the product not expressly authorized by Hi5 Furniture. It also does not apply to "Customer's Own Material" (i.e. material supplied by the customer that is not a standard Hi5 Furniture product offering) used in the manufacture of Hi5 Furniture products. Hi5 Furniture does not warranty the matching of color, grain or texture except to within commercially acceptable standards. A Product will not be considered defective and Hi5 Furniture will not be obligated to replace it, if the product is not installed or used as recommended by Hi5 Furniture.